

Ministério da Saúde

FIOCRUZ

Fundação Oswaldo Cruz

INSTITUTO OSWALDO CRUZ

Programa de Pós-Graduação em Biologia Celular e Molecular

**Rastreamento molecular de uma amostra de pacientes brasileiros com
fenótipo clínico indicativo de Diabetes Monogênico não sindrômico**

GABRIELLA DE MEDEIROS ABREU

RIO DE JANEIRO

2021

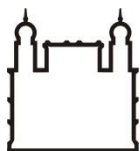

Ministério da Saúde

FIOCRUZ

Fundação Oswaldo Cruz

INSTITUTO OSWALDO CRUZ

Programa de Pós-Graduação em Biologia Celular e Molecular

**Rastreamento molecular de uma amostra de pacientes brasileiros com
fenótipo clínico indicativo de Diabetes Monogênico não sindrômico**

GABRIELLA DE MEDEIROS ABREU

Tese apresentada ao Instituto Oswaldo Cruz
como parte dos requisitos para obtenção do título de
Doutor em Biologia Celular e Molecular

Orientador: Dr. Pedro Hernán Cabello

RIO DE JANEIRO

2021

de Medeiros Abreu, Gabriella.

Rastreamento molecular de uma amostra de pacientes brasileiros com fenótipo clínico indicativo de Diabetes Monogênico não sindrômico / Gabriella de Medeiros Abreu. - Rio de Janeiro, 2021.

xx, 188 f.; il.

Tese (Doutorado) - Instituto Oswaldo Cruz, Pós-Graduação em Biologia Celular e Molecular, 2021.

Orientador: Pedro Hernán Cabello.

Bibliografia: Inclui Bibliografias.

1. Diabetes mellitus. 2. Diabetes monogênico. 3. MODY. 4. Diabetes mitocondrial. 5. Variante. I. Título.

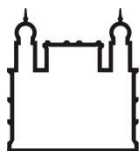

Ministério da Saúde

FIOCRUZ

Fundação Oswaldo Cruz

INSTITUTO OSWALDO CRUZ

Programa de Pós-Graduação em Biologia Celular e Molecular

**Rastreamento molecular de pacientes brasileiros com fenótipos clínicos
indicativos de Diabetes Monogênico**

GABRIELLA DE MEDEIROS ABREU

Orientador: Dr. Pedro Hernán Cabello

Examinadores:

Prof. Dra. Flávia Martinez Carvalho (FIOCRUZ) –Presidente e Revisora

Prof. Dra. Milena Gurgel Teles (USP) – Membro

Prof. Dr. Fernando de Mello Almada Giuffrida (UNEB) – Membro

Prof. Dra. Ana Carolina Ramos Guimarães (FIOCRUZ) – Suplente

Prof. Dra. Fabiana Barzotto Kohlrausch (UFF) – Suplente

Rio de Janeiro, 06 de Julho de 2021

Dedicatória

Às crianças que não puderam sonhar.

Agradecimentos

"*Eu sou o sonho dos meus pais, que eram sonhos dos avós que eram sonhos dos meus ancestrais*". A conquista deste título de doutorado foi possível especialmente devido aos esforços dos meus pais, que tiveram que enfrentar muitos obstáculos pelo caminho, e "*quem costuma vir de onde eu sou as vezes não tem motivo pra seguir*", então eles me ensinaram a levantar e andar e me mostraram que o "*sonho traz coisas que te faz prosseguir*". Guardarei tudo o que vocês fizeram por mim no meu 'matulão' para sempre. (Citações – Emicida).

À minha mãe, Marlene, que tem em si o amor mais genuíno, em sua forma mais crua. Meu maior exemplo de determinação, simplicidade e luta.

Ao meu pai, José Maria, o melhor contador de histórias, que me transmitiu o gene da curiosidade e da criatividade. "*Um homem conta suas histórias tantas vezes, que ele se torna as histórias. Elas sobrevivem a ele. E desta forma, ele se torna imortal*" (Peixe Grande e sua histórias maravilhosas).

Ao meu amor, meu marido e melhor amigo Fábio que dividiu comigo as alegrias e percalços durante o meu doutoramento. Que estava lá no momento em que o peso já era muito grande para minhas costas e me carregou no colo e segurou minha mão, "*aquele toque Beatle I wanna hold your hand*"(Belchior), para deixar a minha caminhada mais leve. Por tudo isso, *Munakuyki*.

À minha irmã, Juliana, por me arrancar as melhores gargalhadas e por me mostrar que mesmo sendo sua "little sis" eu posso ser grande para o mundo.

Aos meus sobrinhos Julia, Cadu e Pietro, por fazerem meu coração florescer com seus sorrisos e suas travessuras.

À minha Vó Antonieta por me ensinar a simplicidade do amor e por sempre me ter em suas orações. Ao meu Vô Valdemar por me mostrar que a felicidade é simples de se alcançar. À minha Vó Celi por sua bondade. Ao meu Vô Jonoca (*In memoriam*) pelas suas histórias.

À minha Tia Marquinha (*In memoriam*) que sempre foi uma mãe pra mim. Tinha "*Em que altura você mora agora? um dia lhe visitarei*" (Emicida /Wilson Das Neves).

À toda minha família Medeiros e Abreu.

Ao meu sogro Alvaro, por ser como um pai para mim.

À minha grande amiga Socorro, que me cuidou tão bem nos momentos em que eu mais precisei.

À minha sogra Sonia, por dividirmos momentos felizes em família.

Aos meus cunhados (as) Eduardo, Vanessa, Juliane, Marina, Rômulo e Leonardo pela irmandade.

Às minhas amigas, da UERJ para vida, Karine e Hayandra, pelo apoio psicológico, pelo aprendizado diário através da diversidade de discussões levantadas e principalmente pelo amor e carinho. “*Quem tem um amigo tem tudo, se o poço devorar, ele busca no fundo*” (Emicida /Wilson Das Neves).

Aos amigos Quiroga (*in memoriam*) e Jorge (*in memoriam*). Vocês sempre serão lembrados pelos sorrisos.

À Dra. Roberta Tarantino, grande idealizadora deste lindo projeto. Obrigada por confiar em mim e sempre estar disposta a seguir nesta caminhada científica e de amizade.

Ao meu orientador e chefe Dr. Pedro Cabello, por me permitir passar por essa experiência incrível de doutorado em um ambiente de trabalho tão acolhedor.

Ao meu orientador de coração e chefe Dr. Mário Campos por mergulhar de cabeça neste projeto de diabetes tão lindo comigo.

À minha chefe Dra. Giselda Cabello por confiar em mim há 5 anos e me permitir viver essa experiência tão gratificante.

À minha chefe e amiga Dra. Verônica Zembruski por todos os conselhos e orientação.

Às minhas amigas Ana Carolina Fonseca e Amanda Cambraia pela amizade que vai além da bancada. Obrigada por todos ensinamentos de experimentos e de vida. “*Ninguém solta a mão de ninguém!*” (Mãe de Thereza Nardelli).

Em especial agradeço às minhas alunas de Iniciação Científica Juliana Rosa, Diana Bastos e Camila Soares por me permitirem orientá-las e principalmente por me ensinarem a ensinar.

À toda equipe do Laboratório de Genética Humana que divide o dia-a-dia comigo ou aos que passaram por lá e deixaram rastro de saudade: Dr. Sérgio Pereira, Bruna Marchesini, Ritiele Bastos, Juliana Chagas, Bianca Lima, Kaio Salum, Alan Clavelland, Tatiane Cozendey, Guilherme Orofino, Guilherme Fonseca, Fernanda Mattos, Karina Santos, Renata Mendes, Ohanna Cavalcanti e Daniele Voigt.

Às Dras. Lenita Zajdenverg e Melanie Rodacki pela grande colaboração neste projeto.

Aos médicos do Instituto Estadual de Diabetes e Endocrinologia Luiz Capriglione e do Hospital Universitário Clementino Fraga Filho da Universidade Federal do Rio de Janeiro pelo encaminhamento dos pacientes.

Aos pacientes e familiares participantes deste estudo.

À Eliane, Alda, Jaci, Alexandre, Cida, Rosângela e toda equipe do apoio laboratorial.

À toda equipe da plataforma multiusuários de Sequenciamento automático do Rio de Janeiro do Instituto Oswaldo Cruz.

Ao programa de Pós-Graduação em Biologia Celular e Molecular, em especial à Julimar e aos representantes dos discentes do programa.

Ao Instituto Oswaldo Cruz.

À Fundação Oswaldo Cruz.

Ao meu professor de Ciências do ensino fundamental por despertar em mim o amor pelo estudo da vida.

Parte deste trabalho foi executado em meio a uma pandemia nunca antes vivida por todos nós, com batalhas diárias, com muitas perdas e angústias do que ainda está por vir. Então eu sou grata a todos que estão na linha de frente e nos serviços essenciais na batalha contra a COVID-19, salvando vidas e que diretamente permitiram que este trabalho fosse finalizado.

A partir da conclusão deste trabalho um ciclo se fecha em minha vida e sou grata por todo ensinamento, tempo e apoio recebido durante a execução deste projeto. A todos que contribuíram de alguma forma para esta conquista, meu muito obrigada!

“Se não houver frutos, valeu a beleza das flores; se não houver flores, valeu a sombra das folhas; se não houver folhas, valeu a intenção da semente.”

(Henfil)

Resumo

O Diabetes *mellitus* (DM) é um importante problema de saúde pública, afetando cerca de 463 milhões de pessoas em todo mundo. As formas mais comuns de DM são as multifatoriais, que respondem por mais de 90% de todos os casos. Entretanto, formas monogênicas de DM também contribuem para esta doença. Estima-se que elas sejam responsáveis por cerca de 3% a 6% dos casos de diabetes. Dentre as formas monogênicas destacam-se o tipo “Maturity-Onset Diabetes of the Young” (MODY), o DM neonatal e o DM sindrômico mitocondrial. O tipo MODY é a forma mais frequente de DM monogênico e caracteriza-se pelo diagnóstico geralmente antes dos 25 anos, histórico familiar com segregação compatível com a forma autossômica dominante e defeito primário na célula β -pancreática. Devido a sua raridade e pouca divulgação, o DM monogênico ainda é subdiagnosticado e pacientes com essas formas frequentemente recebem diagnóstico errôneo, impactando em seu tratamento. No Brasil, ainda são poucos os estudos das formas monogênicas de DM, e até o momento a real contribuição dessas formas na causa de DM na população geral não é totalmente conhecida. Desta forma, o objetivo deste estudo foi selecionar pacientes com fenótipo clínico característico de diabetes monogênico e, através do rastreamento de variantes em diferentes genes, proporcionar o diagnóstico molecular da doença contribuindo para o seu prognóstico, aconselhamento genético e para o tratamento mais adequado destes pacientes. Para isso, foram incluídos 68 probandos com fenótipo clínico de DM monogênico. Os critérios de inclusão foram idade de diagnóstico ≤ 40 anos, IMC < 30 kg/m², ao menos duas gerações afetadas por DM e anticorpos contra células- β (anti-GAD e anti-IA2) negativos. Além disso, 62 familiares e 158 controles saudáveis foram incluídos. A análise molecular dos genes *HNF4A*, *GCK*, *HNF1A*, *PDX1*, *HNF1B*, *NEUROD1*, *KLF11*, *PAX4*, *INS*, *KCNJ11* e *MT-TL1* foi realizada através do sequenciamento de Sanger. Algoritmos *in silico* foram utilizados para acessar o potencial de patogenicidade das variantes identificadas, além da pesquisa nos bancos de dados públicos para checar a ocorrência das variantes encontradas. Como resultado do rastreamento genético, um total de 34 probandos (50%) com variantes candidatas responsáveis pelo DM monogênico foram identificadas. Dezenove variantes foram observadas no *GCK*, nove pacientes com modificações no gene *HNF1A* e uma variante foi identificada nos seguintes genes: *HNF4A*, *HNF1B*, *NEUROD1*, *PAX4*, *PDX1* e *MT-TL1*. O estudo de segregação foi realizado em 19 famílias, totalizando 62 familiares, dos quais 41 (82,9%) apresentaram a variante do probando. Dos 41 familiares positivos, 34 reportaram ter hiperglicemia. Das 32 diferentes variantes identificadas, oito não haviam sido reportadas na literatura, sendo três no gene *GCK* (p.Tir61Asp, p.Met115Val e p.Asp365GlufsTer95), quatro no gene *HNF1A* (p.Val133Glu, p.Tir163Ter, p.Val380CisfsTer39 e p.Tre433HisfsTer116) e uma no gene *NEUROD1* (p.Fen256LeufsTer2). Não foram observadas variantes patogênicas nos genes *KLF11*, *INS* e *KCNJ11*. Com relação ao tratamento, após o diagnóstico molecular, seis pacientes com modificações no gene *GCK* substituíram o tratamento farmacológico para terapia nutricional e um pacientes parou o tratamento com insulina e iniciou o tratamento com antidiabéticos orais. Além disso, dois pacientes com modificações no gene *HNF1A* substituíram o tratamento com insulina para medicamentos orais, com melhor resposta glicêmica. Desta forma, os resultados obtidos neste estudo enfatizam a importância do diagnóstico molecular proporcionando um melhor prognóstico, qualidade de vida e tratamento personalizado.

Palavras-chave: Diabetes *mellitus*; diabetes monogênico; MODY; diabetes mitocondrial; variante; sequenciamento de Sanger

Abstract

Diabetes *mellitus* (DM) is a major public health problem, affecting approximately 463 million people worldwide. The most common forms of DM are multifactorial, which account for more than 90% of all cases. However, monogenic forms of DM also contribute to this disease. It is estimated that they are responsible for about 3% to 6% of diabetes cases. Among the monogenic forms, the major are the Maturity-Onset Diabetes of the Young (MODY), the neonatal DM and the mitochondrial syndromic DM. The MODY type is the most frequent form of monogenic DM and is characterized usually by age of diagnosis before 25 years, family history with segregation compatible with an autosomal dominant form and primary defect in the β -pancreatic cell. Due to its rarity and lack of reports, monogenic DM is still underdiagnosed and patients with these forms are frequently misdiagnosis, impacting in their treatment. Studies aiming monogenic forms of DM are still scarce in Brazil and, until now the real contribution of these forms are not well known. Thus, the aim of this study was recruit patients with clinical phenotype of monogenic diabetes and, through the screening of different genes, provide the molecular diagnosis of the disease contributing to its prognosis, genetic counseling and for the most appropriate treatment of these patients. In this study, 68 probands with clinical phenotype of monogenic DM were included. Inclusion criteria were age of diagnosis ≤ 40 years, BMI < 30 kg/m², at least two generations affected by DM and negative β -cell antibodies (anti-GAD and anti-IA2). In addition, 62 family members and 158 healthy controls were included. Molecular analysis of the *HNF4A*, *GCK*, *HNF1A*, *PDX1*, *HNF1B*, *NEUROD1*, *KLF11*, *PAX4*, *INS*, *KCNJ11* and *MT-TL1* genes was performed using Sanger sequencing. We accessed the pathogenic potential of the identified variants through *in silico* algorithms. In addition, we checked the occurrence of the variants found in public databases. As a result of the genetic screening, a total of 34 probands (50%) with candidate variants responsible for monogenic DM were identified. Nineteen variants were observed in the *GCK*, nine probands with mutations in the *HNF1A* gene and one variant was identified in the following genes: *HNF4A*, *HNF1B*, *NEUROD1*, *PAX4*, *PDX1* e *MT-TL1*. The segregation study was performed in 19 families, totaling 62 family members, whose 41 (82.9%) showed the mutation founded in the proband. Of the 41 positive family members, 34 reported having hyperglycemia. Of de 32 different variants identified; eight had not been reported in the literature, three in the *GCK* gene (p.Tyr61Asp, p.Met115Val, and p.Asp365GlufsTer95), four in the *HNF1A* gene (p.Val133Glu, p.Tyr163Ter, p.Val380CisfsTer39 and p.Thr433HisfsTer116) and one in the *NEUROD1* gene (p.Phe256LeufsTer2). No pathogenic variants were observed in the *KLF11*, *INS* and *KCNJ11* genes. Regarding the treatment, after the molecular diagnosis, six patients with mutations in the *GCK* gene switch the treatment from pharmacological to nutritional therapy and one patient stopped the insulin and started oral antidiabetic treatment. Additionally, two patients with mutations in the *HNF1A* gene substituted the insulin to oral antidiabetic treatment, with a better glycemic responses. In conclusion, the results obtained in this study highlights the importance of the molecular diagnosis providing an improved prognosis, quality of life and personalized treatment.

Keywords: Diabetes *mellitus*; monogenic diabetes; MODY; mitochondrial diabetes; mutation; Sanger sequencing

Lista de Figuras

- Figura 1.** Homeostase dos níveis de glicose sanguínea através da liberação de insulina e glucagon pelo pâncreas. Fonte: O autor, Adaptado de (12).2
- Figura 2.** Pacientes com diabetes *mellitus* neonatal referidos ao *Diabetes Genes* da Universidade de Exeter por país. Fonte: (43,50,51). About Neonatal Diabetes. Diabetes genes, 2021. Disponível em: <<https://www.diabetesgenes.org/about-neonatal-diabetes/>>. Acesso em 04 de maio de 2021..... 8
- Figura 3.** Doenças relacionadas à variante m.3243A>G no gene mitocondrial *MT-TL1*, e seus fatores moduladores. Uma única célula humana pode conter mitocôndrias com DNAm em homoplasmia (verde) ou em heteroplasmia (vermelho), ainda, uma mitocôndria pode conter DNAm mutado (vermelho) e selvagem (verde). A mutação m.3243A>G está presente no gene *MT-TL1* que codifica o RNAt de leucina (A). O fenótipo observado nos indivíduos portadores da mutação m.3243A>G dependerá de vários fatores (B). Os sintomas clínicos dos pacientes são heterogêneos e são influenciados pelo grau de heteroplasmia e pelos moduladores do fenótipo (C). Fonte: O autor, Adaptado de (66)..... 11
- Figura 4.** Diagrama de interseção entre genes associados ao diabetes poligênico e monogênico. Fonte: O autor, Adaptado de (48). 15
- Figura 5.** Representação do gene *GCK* e dos domínios da proteína glicoquinase. Na figura estão representados os 10 éxons do gene. O íntron 1 é o maior de todos, possuindo 35.445 pares de bases e está fora da escala (linha pontilhada). As regiões não traduzidas 5' e 3' estão apresentadas em cinza. Transcrito NM_000162.5. Fonte: O autor. 18
- Figura 6.** Via metabólica da enzima glicoquinase. G6P: Glicose-6-fosfato; GKb: glicoquinase presente na célula-β; GKf: glicoquinase presente no fígado; GLUT2: transportadores de glicose de isoforma 2; GLUT4: transportadores de glicose de isoforma 4. Fonte: O autor, Adaptado de (115). 19
- Figura 7.** Efeito de mutações na proteína glicoquinase na modificação do limiar para secreção de insulina estimulada pela glicose. HHPI: hipoglicemia hiperinsulinêmica persistente de infância. Fonte: Modificado de (130). 20
- Figura 8.** Representação do gene *HNF1A* e dos domínios do fator de transcrição HNF1A. Na figura estão representados os 10 éxons do gene. As regiões não traduzidas 5' e 3' estão apresentadas em cinza. Transcrito NM_000545.8. Fonte: O autor. 23
- Figura 9.** Modelo de ativação do HNF1A. O cofator de dimerização do hepatócito nuclear fator 1 (DCoH) funciona como um dímero (meia lua em amarelo e cinza) e o HNF1A (azul e rosa), inativos no citoplasma (A). O tetrâmero formado pelo dímero de DCoH e HNF1A se localiza no núcleo e se liga ao DNA (B). Quando o DCoH se desassocia do dímero de HNF1A, o desestabiliza (C). Neste momento o DCoH pode se associar novamente ao dímero de HNF1A (B) ou formar um homotetrâmero inativo desestabilizando o dímero de HNF1A (D). Fonte: O autor, Adaptado de (144). 24
- Figura 10.** Funcionamento do canal de potássio nas células-β. Em células normais, durante a homeostase, os canais de potássio encontram-se abertos permitindo a passagem do potássio para o meio extracelular. Em detalhe o canal de potássio formado pelo octâmero contendo um tetrâmero central de Kir6.2, envolto por quatro subunidades de SUR1 (A). Quando há aumento da razão de ATP/ADP, devido à alta concentração de glicose no meio intracelular,

ocorre o fechamento dos canais de potássio e abertura dos canais de cálcio que são voltagem dependente e levarão à liberação de insulina (B). Em pacientes com mutações no gene *HNF1A*, mesmo em altas concentrações de glicose há pouca liberação da insulina (C). O fármaco sulfonilureia atua estimulando o fechamento dos canais de potássio, possibilitando a liberação da insulina endógena (D). Fonte: O autor. Adaptado de (167).....26

Figura 11. Representação do gene *HNF4A*. Na figura estão representados os dez éxons do gene e as 12 isoformas diferentes produzidas através dos seus dois promotores representados no esquema pela seta horizontal. Transcrito NM_000457.5. Fonte: O autor, Adaptado de (176,177)28

Figura 12. Representação do gene *HNF1B* e dos domínios do fator de transcrição HNF1B. Na figura estão representados os 9 éxons do gene. As regiões não traduzidas 5' e 3' estão apresentadas em cinza. Transcrito NM_000458.4. Fonte: O autor.31

Figura 13. Características frequentemente observadas em pacientes com doenças associadas a modificações no gene *HNF1B* ou alterações em genes alvos regulados pelo fator de transcrição HNF1B (em vermelho). Fonte: O autor, Adaptado de (194,196).....33

Figura 14. Diagrama da molécula humana de pré-pró-insulina. Fonte: O autor, adaptado de (48).35

Figura 15. Representação do gene *KLF11* e dos domínios do fator de transcrição KLF11. Na figura estão representados os quatro éxons do gene. As regiões não traduzidas 5' e 3' estão apresentadas em cinza. Transcrito NM_003597.5. Fonte: O autor.36

Figura 16. Representação do gene *KCNJ11* demonstrando seu único éxon, que é responsável por codificar a subunidade Kir6.2 dos canais de potássio (K⁺ATP). As regiões não traduzidas 5' e 3' estão apresentadas em cinza. Na parte inferior esquerda da figura está apresentada a representação gráfica da subunidade Kir6.2 inserida na membrana plasmática. Transcrito NM_000525.4. Fonte: O autor.38

Figura 17. Representação do gene *NEUROD1* e dos domínios do fator de transcrição NEUROD1. Na figura estão representados os dois éxons do gene. A região exônica não traduzidas está representada em cinza claro e as regiões não traduzidas 5' e 3' estão apresentadas em cinza escuro. bHLH: “basic adjacent, helix 1, loop and helix 2” Transcrito NM_002500.5. Fonte: O autor.39

Figura 18. Ativação do gene da insulina (*INS*) via NEUROD1. P: fosforilação; G: O-glicosilação com N-acetil-glucosamina. Fonte: O autor, Adaptado de (236).40

Figura 19. Representação do gene *PAX4* e dos domínios do fator de transcrição PAX4. Na figura estão representados os 12 éxons do gene. As regiões exônicas não traduzidas estão representadas em cinza claro e a região não traduzida 3' está apresentada em cinza escuro. Transcrito NM_001366110.1. Fonte: O autor.41

Figura 20. Representação simplificada da regulação cruzada entre os fatores de transcrição PAX4 e ARX para promover a diferenciação das células endócrinas. A seta em vermelho representa inibição. Fonte: O autor, adaptado de (241).....42

Figura 21. Representação do gene *PDX1* e dos domínios do fator de transcrição PDX-1. Na figura estão representados os 2 éxons do gene. As regiões 5' e 3' não traduzidas estão representadas em cinza. Transcrito NM_000209.4. Fonte: O autor.43

Figura 22. Distribuição das modificações identificadas neste estudo ao longo dos éxons do gene *GCK*. Em vermelho estão destacadas as modificações novas. Fonte: O autor. 138

Figura 23. Distribuição das modificações identificadas neste estudo ao longo dos éxons do gene *HNF1A*. Em vermelho estão destacadas as modificações novas. Fonte: O autor. 139

Lista de Fluxogramas, Tabelas e Gráficos

Fluxograma 1. Tipos de Diabetes <i>mellitus</i> . LADA: latent autoimmune diabetes of adults; IPEX: immune dysregulation, polyendocrinopathy, enteropathy, X-linked; DMG: diabetes <i>mellitus</i> gestacional; DNG: diabetes na gravidez. Fonte: O autor, Adaptado de (24).....	5
Fluxograma 2. Critérios de diagnóstico e características clínicas e recomendações terapêuticas dos principais tipos de diabetes monogênico. Fonte: O autor, Adaptado de (97).	16
Tabela 1. Formas de diabetes <i>mellitus</i> do tipo Maturity-Onset Diabetes of the Young.....	13
Gráfico 1. Modificações identificadas neste estudo, distribuídas por gene.....	132
Gráfico 2. Suspeita de diagnóstico clínico <i>versus</i> diagnóstico molecular pacientes do grupo GCK-MODY.	133
Gráfico 3. Suspeita de diagnóstico clínico <i>versus</i> diagnóstico molecular pacientes do grupo não GCK-MODY.....	134
Gráfico 4. Tratamento dos pacientes identificados com DM monogênico antes do diagnóstico molecular.....	135
Gráfico 5. Distribuição de familiares com diabetes ou não <i>versus</i> a presença e ausência da modificação.....	136
Gráfico 6. Tipos de modificações identificadas nesse estudo por gene.....	137

Lista de Siglas e Abreviaturas

ABCC8	<i>ATP binding cassette subfamily C member 8</i>
ACMG	“American College of Medical Genetics and Genomics”
AF	Domínio N-terminal com função de ativação 1 (“activation function”)
AHO	Agentes hipoglicemiantes orais
BLK	<i>B lymphoid tyrosine kinase</i>
Ca²⁺	Canais de cálcio
CCV	Complicações cardiovasculares
CEL	<i>Carboxyl-ester lipase</i>
DBD	Domínio de ligação ao DNA (“DNA-binding domain”)
DEND	Atraso no desenvolvimento, epilepsia e diabetes neonatal (“Developmental delay, Epilepsy, and Neonatal Diabetes”)
DM	Diabetes <i>mellitus</i>
DMG	Diabetes <i>mellitus</i> gestacional
DMN	Diabetes <i>mellitus</i> neonatal
DMNP	Diabetes <i>mellitus</i> neonatal permanente
DMNT	Diabetes <i>mellitus</i> neonatal transitória
DNAm	DNA mitocondrial
DNG	Diabetes na gravidez
DRC	Doença renal crônica
GCK	<i>Glicoquinase</i>
GJ	Glicose em jejum
GLUT2	Transportador de glicose de isoforma 2
GRP	Proteína reguladora da glicoquinase (“glucokinase regulatory protein”)
HbA1c	Hemoglobina glicada
HDL	Colesterol das lipoproteínas de alta densidade (high-density lipoproteins”)
HHPI	Hipoglicemia hiperinsulinêmica persistente da infância
HNF1A	<i>HNF1 homeobox A</i>
HNF1B	<i>HNF1 Homeobox B</i>
HNF4A	<i>Hepatocyte Nuclear Factor 4-Alpha</i>
ID	Idade de diagnóstico
IG	Intolerância à glicose
IGJ	Intolerância à glicose em jejum
INS	<i>Insulin</i>
IPEX	“Immune dysregulation, polyendocrinopathy, enteropathy, X-linked”

kb	Kilobases
KCNJ11	<i>Potassium Channel, Inwardly Rectifying, Subfamily J, Member 11</i>
KLF11	<i>Kruppel-Like Factor 11</i>
LADA	“Latent autoimmune diabetes of adults”
LBD	Domínio de ligação ao ligante lipofílico (“lipophilic ligand binding domain”)
LDL	Colesterol das lipoproteínas de baixa densidade (“low density lipoproteins”)
LIEG	Liberação de insulina estimulada por glicose
Mb	Megabase
MELAS	Síndrome da encefalopatia mitocondrial, acidose láctica e episódios de derrames (“mitochondrial encephalopathy, lactic acidosis, and stroke-like episodes”)
MIDD	Diabetes e surdez de herança materna (“maternally inherited diabetes and deafness”)
MPC	Calculadora de probabilidade de diagnóstico de MODY (“MODY probability calculator”)
MODY	“Maturity-Onset Diabetes of the Young”
MT-TL1	<i>Mitochondrially encoded tRNA leucine 1</i>
NEUROD1	<i>Neuronal differentiation 1</i>
NLS	Sinal de localização nuclear (“Nuclear localization signal”)
P1	Promotor 1
P2	Promotor 2
PAX4	<i>Paired Box Gene 4</i>
pb	Pares de bases
PCR-as	Proteína C-reativa sérica de alta sensibilidade
PDX1	<i>Pancreatic and Duodenal Homeobox 1</i>
PEO	Oftalmoplegia externa progressiva crônica (“progressive external ophthalmoplegia”)
POUh	POU homeodomínio
POUs	POU domínio específico
RE	Retículo endoplasmático
RNAr	RNA ribossomal
RNAt	RNA transportador
SRP	Partícula de sinal de reconhecimento (“signal-recognition particle”)
TOTG	Teste oral de tolerância a 75 gramas de glicose
UTR	Região do DNA não traduzida (“untranslated region”)

Índice

Dedicatória.....	v
Agradecimentos.....	vi
Resumo.....	x
Abstract.....	xi
Lista de Figuras.....	xii
Lista de Fluxogramas, Tabelas e Gráficos.....	xv
Lista de Siglas e Abreviaturas.....	xvi
1. Introdução.....	1
1.1 Homeostase da glicose.....	1
1.2 Testes de diagnóstico para diabetes <i>mellitus</i>	2
1.3 Prevalência do diabetes <i>mellitus</i>	3
1.4 Complicações do diabetes <i>mellitus</i>	3
1.5 Tipos de diabetes <i>mellitus</i>	4
1.5.1 Diabetes <i>mellitus</i> do tipo 1.....	5
1.5.2 Diabetes <i>mellitus</i> do tipo 2.....	6
1.5.3 Hiperglicemia na gravidez.....	7
1.5.4 Diabetes <i>mellitus</i> monogênico.....	7
1.5.4.1 Diabetes <i>mellitus</i> neonatal.....	8
1.5.4.2 Diabetes <i>mellitus</i> sindrômico mitocondrial.....	9
1.5.4.3 Maturity-Onset Diabetes of the Young.....	12
1.6. Genética do diabetes <i>mellitus</i>	15
1.7 Critérios clínicos utilizados para inclusão no estudo de formas monogênicas do DM.....	16
1.8 Formas comuns de diabetes do tipo MODY.....	17
1.8.1 Modificações no gene <i>GCK</i> associadas ao diabetes monogênico.....	17
1.8.1.1 O gene <i>GCK</i>	17
1.8.1.2 A via metabólica da enzima glicoquinase.....	18
1.8.1.3 Resposta biológica a modificações estruturais na enzima glicoquinase.....	19
1.8.1.4 Características clínicas e controle glicêmico dos pacientes GCK-MODY.....	20
1.8.1.5 GCK-MODY e a gravidez.....	21
1.8.2 Modificações no gene <i>HNF1A</i> associadas ao diabetes monogênico.....	22
1.8.2.1 O gene <i>HNF1A</i>	22
1.8.2.2 Resposta biológica a modificações estruturais no fator de transcrição HNF1A.....	24
1.8.2.3 Características clínicas e controle glicêmico dos pacientes HNF1A-MODY.....	25

1.8.3	Modificações no gene <i>HNF4A</i> associadas ao diabetes monogênico.....	27
1.8.3.1	O gene <i>HNF4A</i>	27
1.8.3.2	Características clínicas e controle glicêmico dos pacientes <i>HNF4A</i> -MODY.....	29
1.8.4	Modificações no gene <i>HNF1B</i> associadas ao diabetes monogênico.....	30
1.8.4.1	O gene <i>HNF1B</i>	31
1.8.4.2	Características clínicas e controle glicêmico dos pacientes com modificações no gene <i>HNF1B</i>	32
1.9	Formas raras do diabetes monogênico.....	34
1.9.1	Modificações no gene <i>INS</i> associadas ao diabetes monogênico.....	34
1.9.2	Modificações no gene <i>KLF11</i> associadas ao diabetes monogênico.....	35
1.9.3	Modificações no gene <i>KCNJ11</i> associadas ao diabetes monogênico.....	37
1.9.4	Modificações no gene <i>NEUROD1</i> associadas ao diabetes monogênico.....	38
1.9.5	Modificações no gene <i>PAX4</i> associadas ao diabetes monogênico.....	40
1.9.6	Modificações no gene <i>PDX1</i> associadas ao diabetes monogênico.....	42
1.10	Impacto do diagnóstico molecular no prognóstico do diabetes monogênico.....	43
2.	Objetivos	44
2.1	Objetivo geral.....	44
2.2	Objetivos específicos.....	44
3.	Resultados	45
	Capítulo I.....	45
	Capítulo II.....	53
	Capítulo III.....	60
	Capítulo IV.....	70
	Capítulo V.....	81
4.	Discussão	131
5.	Conclusões	142
6.	Referências	144
7.	Anexos	169
7.1	Anexo A. Termo de consentimento livre e esclarecido do HUCFF.....	169
7.2	Anexo B. Termo de consentimento livre e esclarecido do IEDE.....	171
7.3	Anexo C. Questionário.....	173
7.4	Anexo D. Resultados do sequenciamento de Sanger para o rastreamento dos 11 genes analisados.....	174
7.4.1	Resultados do sequenciamento de Sanger para o rastreamento do gene <i>GCK</i>	174
7.4.2	Resultados do sequenciamento de Sanger para o rastreamento do gene <i>HNF1A</i>	175
7.4.3	Resultados do sequenciamento de Sanger para o rastreamento do gene <i>HNF4A</i>	178

7.4.4 Resultados do sequenciamento de Sanger para o rastreamento do gene <i>HNFB</i>	180
7.4.5 Resultados do sequenciamento de Sanger para o rastreamento dos genes <i>INS</i> , <i>PDX1</i> , <i>NEUROD1</i> , <i>KCNJ11</i> e <i>KLF11</i>	182
7.4.6 Resultados do sequenciamento de Sanger para o rastreamento dos genes <i>PAX4</i> e <i>MT-TL1</i>	185
7.5 Anexo E. Modelo de relatório de pesquisa.....	187

1. Introdução

O Diabetes *mellitus* (DM) é uma doença crônica decorrente do aumento de glicose na corrente sanguínea devido ao não funcionamento correto na produção, liberação ou atuação da insulina endógena. A insulina é um hormônio liberado pelo pâncreas e atua permitindo a entrada da glicose nas células, onde esse açúcar será convertido em energia. Além disso, esse hormônio é essencial para o bom funcionamento do metabolismo das proteínas e colesterol. Quando ocorre uma falha no metabolismo da insulina, há um aumento dos níveis de glicose no sangue levando à hiperglicemia (1).

1.1 Homeostase da glicose

O pâncreas dos mamíferos possui duas funções distintas, a exócrina e a endócrina. As células endócrinas são organizadas nas ilhotas de Langerhans e podem ser classificadas em cinco tipos diferentes: 1) Célula alfa (α), responsável por secretar glucagon; 2) Célula beta (β), responsável por secretar insulina; 3) Célula delta (δ), responsável por secretar somatostatina; 4) Célula épsilon (ϵ), responsável por secretar grelina; e 5) Células PP, responsável por produzir polipeptídeos pancreáticos (2).

Através da regulação entre os hormônios glucagon, produzido pelas células α -pancreáticas, e insulina, produzida pelas células β -pancreáticas (3), o pâncreas mantém a homeostase da glicose entre 4-6 mM. A insulina é estimulada pelo aumento de glicose exógena na corrente sanguínea após as refeições (4), e a insulina se liga nos receptores nos tecidos musculares e adiposo permitindo a captação de glicose dependente de insulina para estes tecidos e, conseqüentemente, diminuindo os níveis de glicose exógena na corrente sanguínea (5,6). Além disso, a insulina promove a glicogênese (7), lipogênese (8,9) e a incorporação de aminoácidos nas proteínas (10). De maneira oposta, quando os níveis de glicose sanguínea estão baixos, como no período compreendido entre as refeições, ou durante o sono, ocorre liberação do glucagon para promover a glicogenólise hepática. Além disso, o glucagon promove a gliconeogênese renal e hepática para aumentar os níveis de glicose sanguínea endógena durante momentos longos de jejum (11) (**Figura 1**).



Figura 1. Homeostase dos níveis de glicose sanguínea através da liberação de insulina e glucagon pelo pâncreas. **Fonte:** O autor, Adaptado de (12).

1.2 Testes de diagnóstico para diabetes *mellitus*

O Diabetes pode ser diagnosticado através do exame de glicose em jejum (GJ), na medição da glicose no plasma após 2 horas no teste oral de tolerância a 75 gramas de glicose (TOTG), através dos valores de hemoglobina glicada (HbA1c) e em pacientes com sintomas clássicos de hiperglicemia ou crises hiperglicêmicas. Esses testes também podem ser utilizados para detectar pacientes com pré-diabetes. O DM é caracterizado quando $GJ \geq 126$ mg/dl (≥ 7 mmol/l) ou valores de glicose plasmática no TOTG ≥ 200 mg/dl ($\geq 11,1$ mmol/mol) ou HbA1c $\geq 6,5\%$ (≥ 48 mmol/mol) ou com glicose plasmática randômica ≥ 200 mg/dl ($\geq 11,1$ mmol/mol) na presença de sintomas de hiperglicemia (13). A intolerância à glicose (IG) e a intolerância à glicose em jejum (IGJ) são condições onde os níveis de glicose estão acima do normal, entretanto estão abaixo dos níveis recomendados para caracterizá-los como diabetes, sendo conhecidos como pré-diabetes, hiperglicemia não-diabética ou intermediária (1,14).

1.3 Prevalência do diabetes *mellitus*

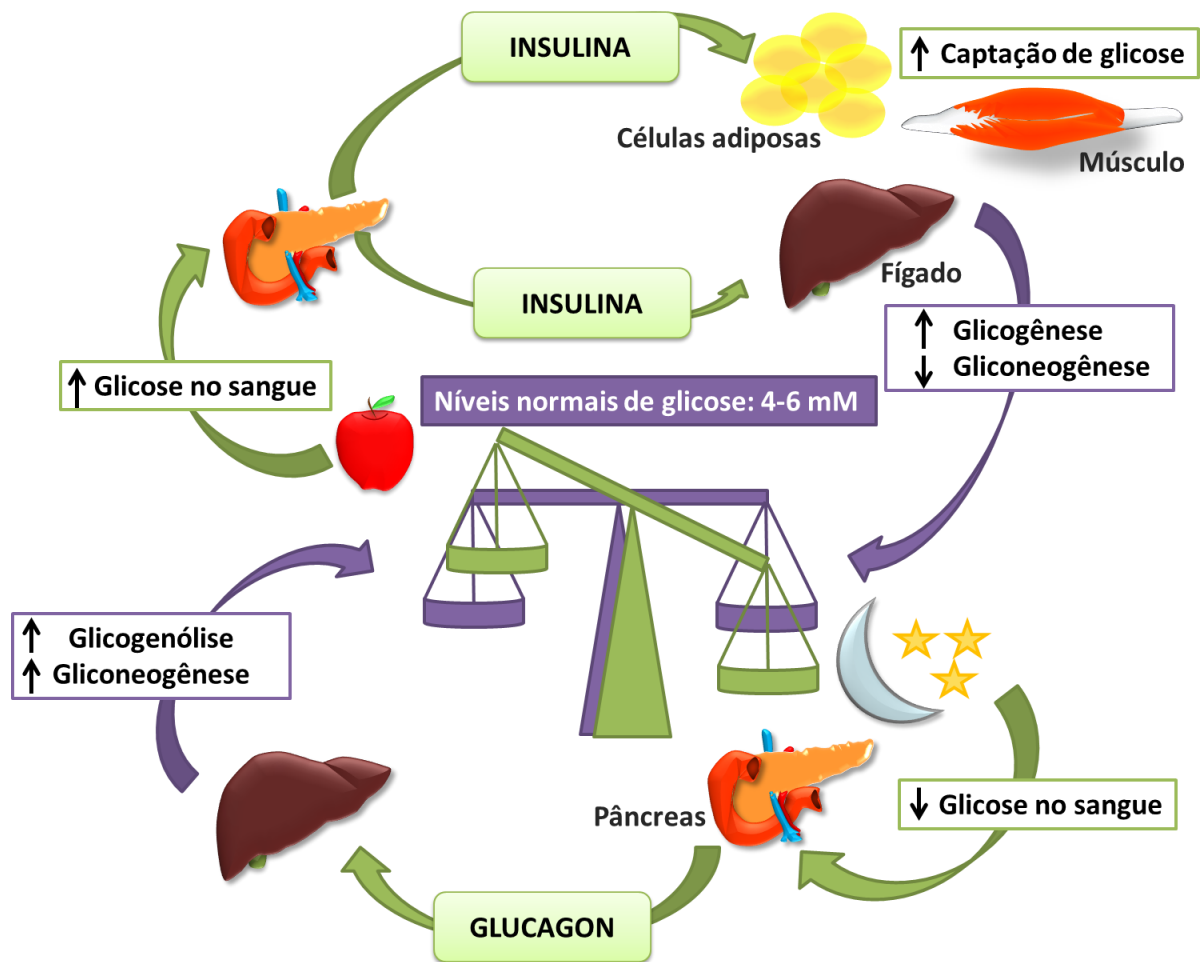
De acordo com a Federação Internacional de Diabetes (2019) cerca de 463 milhões de adultos (20-79 anos) vivem com diabetes no mundo, entretanto metade destes casos continuam subdiagnosticados. O Brasil é o quinto país com maior número de casos (16,8 milhões), atrás apenas da China, Índia, Estados Unidos e Paquistão. Estima-se que 7,7 milhões de brasileiros (46%) não sabem de sua condição. Em 2019, a prevalência de crianças e adolescentes (0-14 anos) brasileiros com DM foi de 51,5 mil casos. Acredita-se que em 2045 cerca de 26 milhões de brasileiros em idade adulta viverão com DM. O diabetes e suas complicações representam importantes problemas para a saúde pública mundial, sendo responsável pela morte de 4,2 milhões de adultos (20-79 anos) em 2019. Além do impacto social, o DM tem impacto econômico. Em 2019 o Brasil foi o terceiro país com mais gastos na saúde e no tratamento de pacientes adultos com DM (52,3 bilhões de dólares), uma média de cerca de 3 mil dólares por pessoa (1).

1.4 Complicações do diabetes *mellitus*

Com a progressão da doença, a deficiência de insulina pode acarretar complicações graves como retinopatia, neuropatia, nefropatia, além de aumentar o risco de complicações cardiovasculares (CCV). O aumento de glicose sanguínea também está associado a outras comorbidades, como hipertensão, dislipidemia e obesidade (1).

A comorbidade mais preocupante entre os pacientes com DM é a perda da visão. Mais de 93 milhões de indivíduos no mundo convivem com alguma complicação ocular devido ao DM. Estes pacientes podem apresentar condições como catarata, glaucoma, visão dupla e inabilidade de focar, além da retinopatia. Dentre estas complicações, a retinopatia diabética é a única que é diretamente ocasionada pelo DM, e pode levar à cegueira. A retinopatia diabética ocorre devido aos danos nos capilares da retina, que levam ao vazamento e entupimento dos capilares (1,15,16). A retinopatia diabética tem prevalência de 34,6%, sendo o risco de desenvolvimento dessa condição aumentado com o tempo de exposição à doença (16).

A neuropatia periférica atinge mais comumente os nervos distais dos pés, e membros inferiores, mas também pode atingir as mãos, alterando a função sensorial simétrica levando à falta de sensibilidade e dormência. Esses sintomas podem levar ao desenvolvimento de úlceras devido a traumas externos e/ou distribuição incorreta da pressão óssea interna, levando ao “pé diabético” (1,17). O pé diabético pode levar à amputação dos membros inferiores, sendo a chance de amputação cerca de 10 a 20 vezes maior quando comparada a

indivíduos sem diabetes (18). Estima-se que a prevalência da amputação do membro inferior dentre pacientes com DM gira em torno de 0,03% a 1,5% (19).

A doença renal crônica (DRC) pode ser resultante da nefropatia diabética ou de outras condições associadas ao DM, como a hipertensão, disfunção neuropática da bexiga, aumento da incidência de infecções do trato urinário de repetição e macroangiopatia. A hiperglicemia induz a hiperfiltração e mudanças morfológicas nos rins que, conseqüentemente, levam ao aumento da excreção urinária de albumina, dano nas células epiteliais viscerais dos rins (podócitos) e perda da superfície de filtração [ver revisão em (20)]. O risco de morte devido doença renal terminal entre os pacientes com DM é dez vezes maior quando comparado aos indivíduos sem DM (1).

O DM quando não controlado, favorece o aparecimento de doenças periodontais, como a periodontite, e pode levar a perda do dente. A ocorrência de periodontite recorrente em pacientes com diabetes pode afetar o controle glicêmico destes indivíduos, com conseqüente aumento do risco de complicações como a retinopatia, nefropatia e doenças cardiovasculares. Desta forma, percebe-se que há uma associação bidirecional entre o quadro clínico destas duas condições (21).

Além disso, os níveis elevados de glicose ao longo do tempo aumentam a chance de aparecimento de complicações cardiovasculares (CCV) através de vários fatores, como pela resistência à insulina, inflamação, disfunção do epitélio e através dos efeitos de toxicidade da glicose na microvasculatura (22). As CCV são as principais causas de morbidade e mortalidade dos pacientes com DM, sendo responsáveis por cerca de 1/3 a 1/2 das mortes (1); o risco de CCV entre os pacientes com DM é duas vezes maior do que em indivíduos sem a doença (23). As complicações cardiovasculares incluem doença arterial coronariana, doença cerebrovascular, doença arterial periférica e insuficiência cardíaca congestiva que podem levar à síndrome coronariana aguda, infarto do miocárdio, isquemia, acidente vascular cerebral hemorrágico e à morte (1).

1.5 Tipos de diabetes *mellitus*

O Diabetes *mellitus* é uma doença altamente heterogênea podendo ser classificada em diversos subtipos como podemos ver no fluxograma abaixo:

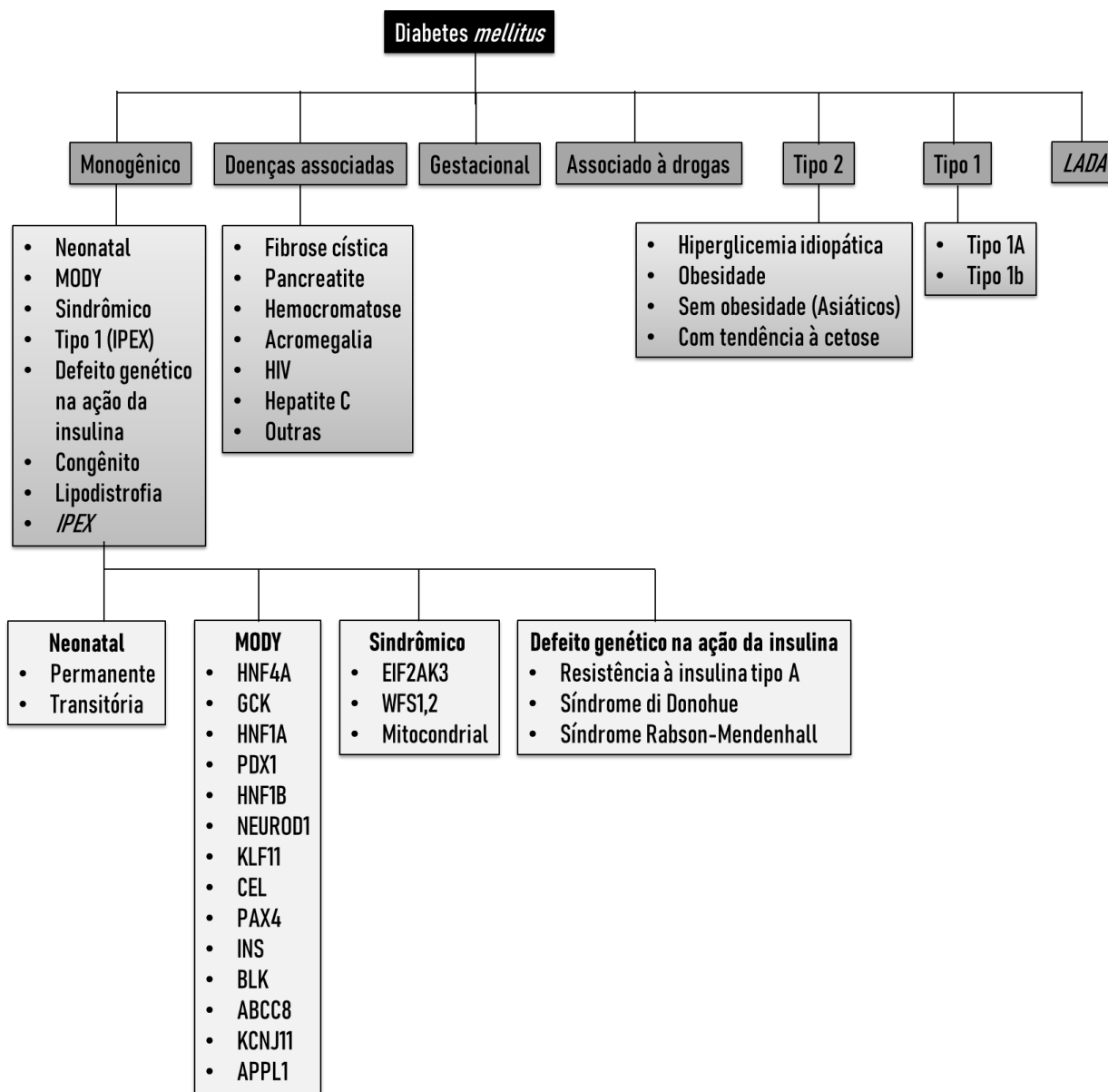

Fluxograma 1. Tipos de Diabetes *mellitus*. LADA: latent autoimmune diabetes of adults; IPEX: immune dysregulation, polyendocrinopathy, enteropathy, X-linked; DMG: diabetes *mellitus* gestacional; DNG: diabetes na gravidez. **Fonte:** O autor, Adaptado de (24).

1.5.1 Diabetes *mellitus* do tipo 1

O DM do tipo 1 é uma doença autoimune em que os linfócitos atacam as células β -pancreáticas, desta forma o pâncreas produz pouca ou nenhuma insulina. A frequência de DM do tipo 1 varia entre diferentes populações. Um estudo conduzido em uma grande coorte Norte Americana de adultos diabéticos e de indivíduos saudáveis identificaram o diabetes do tipo 1 como sendo responsável por 5,6% dos casos na amostra de pacientes (25). Até o momento, o processo pelo qual ocorre o desenvolvimento deste tipo de DM não é totalmente entendido, sabe-se que há fatores genéticos e ambientais envolvidos (26). O DM do tipo 1

pode se manifestar em qualquer idade, entretanto é mais comum na infância ou na puberdade. Os sintomas comumente observados no DM são a polidipsia (sede excessiva), poliúria (urina em excesso), rápida perda de peso, fome em excesso, fadiga, visão borrada, além da presença de corpos cetônicos, levando à cetoacidose diabética. Visto que estes indivíduos produzem pouca ou nenhuma insulina endógena, eles precisam diariamente de injeções de insulina para manter os níveis de glicose na taxa adequada (1,27).

1.5.2 Diabetes *mellitus* do tipo 2

Pacientes com DM do tipo 2 possuem resistência à insulina com disfunção de célula- β , levando a falta de resposta à insulina produzida, resultando em hiperglicemia. Este tipo de DM é mais comumente encontrado entre adultos, entretanto com o aumento da obesidade infantil nas últimas décadas, o número de crianças e adolescentes com este tipo de DM tem crescido (1,28,29). Na população Norte Americana, o DM do tipo 2 foi descrito responsável por mais de 90% dos casos da doença (25). Segundo dados do “Global Burden of Disease Project” (GBDP), estima-se que no ano de 2017, o DM do tipo 2 tenha sido responsável por 96% dos casos de DM no Brasil, enquanto que os 4% restantes seriam ocasionados pelo DM do tipo 1 (30). Para as formas monogênicas não são apresentados dados.

A causa do DM do tipo 2 ainda não foi completamente elucidada, mas sabe-se que há uma interação entre fatores de risco genéticos e ambientais. Entre as causas ambientais, a obesidade, o sobrepeso e o sedentarismo são as causas mais associadas com o aparecimento desta doença, assim como o aumento da idade e histórico familiar (31). Pacientes com DM do tipo 2 podem apresentar as mesmas complicações clínicas do tipo 1, contudo os sintomas geralmente são menos graves ou ausentes. A cetoacidose diabética no diagnóstico, e mesmo no curso da doença, é bem menos comum do que observado no DM do tipo 1 (32). O controle glicêmico destes pacientes geralmente ocorre através da mudança do estilo de vida com uma dieta equilibrada, prática de exercícios físicos e, em alguns casos, quando isto não é o suficiente, recomenda-se o controle dos níveis glicêmicos através de medicamentos orais, como o uso de metformina ou uma combinação de medicamentos. Quando não há o controle glicêmico mesmo com medicamentos orais, pode ser necessária a utilização de injeções de insulina (1).

1.5.3 Hiperglicemia na gravidez

Segundo a Organização Mundial da Saúde e a Federação Internacional de Ginecologia e Obstetrícia, a hiperglicemia na gravidez pode ser dividida em diabetes *mellitus* gestacional (DMG) ou diabetes na gravidez (DNG) (33,34). A estimativa global em 2013 da prevalência da hiperglicemia na gravidez foi de 16,9%, sendo a DMG responsável por 75% a 90% dos casos. A DMG ocorre quando é diagnosticada na gravidez durante qualquer período (geralmente após 24 semanas). Enquanto que mulheres com DNG são aquelas previamente portadoras de DM, mas só foram diagnosticadas na gravidez. A DNG pode ser identificada em qualquer semana da gravidez, incluindo o primeiro trimestre (33–35). Os fatores de risco para desenvolvimento de DMG são idade materna avançada, sobrepeso e obesidade, DMG em gravidez anterior, excesso de peso ganho durante a gestação, histórico familiar de DM, síndrome do ovário policístico, fumo e histórico de bebê com malformações congênitas (anomalias cardíacas, dos membros, do tubo neural e do sistema musculoesquelético) (1,36–38). Gestantes com hiperglicemia podem apresentar pressão alta e tem um risco elevado de terem bebês macrossômicos (bebês maiores para a idade gestacional), podendo dificultar o parto normal. O diagnóstico precoce da hiperglicemia gestacional reduz o risco destas complicações com controle glicêmico através de uma dieta saudável, exercícios e monitoramento dos níveis de glicose, ou mesmo utilização de medicamentos orais e injeções de insulina, quando necessário (1). Mulheres que apresentem DMG tem um risco aumentado de desenvolvimento de DM nos primeiros três a seis anos após o nascimento do bebê. O risco de desenvolver DM do tipo 2 em mulheres que apresentaram DMG é sete vezes maior quando comparadas a mulheres que não apresentaram hiperglicemia na gravidez (39,40). A exposição do bebê à hiperglicemia materna aumenta a chance de sobrepeso e obesidade na criança, além disso o bebê pode apresentar resistência à insulina e intolerância à glicose (1,41).

1.5.4 Diabetes *mellitus* monogênico

As formas monogênicas de DM são ocasionadas por alterações em um único gene e respondem por cerca de 3% a 6% do total de casos (42–44). Entretanto, esse número pode ser ainda maior visto que grande parte dos casos monogênicos permanece sem diagnóstico ou são erroneamente diagnosticados como DM do tipo 1 ou DM do tipo 2, principalmente em países que não possuem testes genéticos como rotina (45–47), como é o caso do Brasil. Os principais tipos de DM monogênico são o “Maturity-Onset Diabetes of the Young” (MODY) e o DM neonatal (DMN) que são resultantes de mutações em genes que codificam fatores de transcrição ou proteínas que regulam o desenvolvimento e função do pâncreas endócrino (48).

Além disso, mutações em genes no DNA mitocondrial também são descritas causar diabetes monogênico (49).

1.5.4.1 Diabetes *mellitus* neonatal

O diabetes *mellitus* neonatal (DMN) é raro, sua incidência gira em torno de um caso em cada 100 mil nascidos vivos. Até julho de 2019, 2.273 pacientes foram referidos ao *Diabetes Genes* da Universidade de Exeter, sendo 10 pacientes brasileiros (43,50,51) (**Figura 2**). O DMN se classifica pelo diagnóstico antes dos 6 meses de idade, podendo persistir ao longo da vida, denominando-se diabetes *mellitus* neonatal permanente (DMNP), ou ser transitória, denominado diabetes *mellitus* neonatal transitório (DMNT), desaparecendo durante a infância e, frequentemente, reaparecendo na vida adulta (52,53).



Figura 2. Pacientes com diabetes *mellitus* neonatal referidos ao *Diabetes Genes* da Universidade de Exeter por país. **Fonte:** (43,50,51). About Neonatal Diabetes. Diabetes genes, 2021. Disponível em: <<https://www.diabetesgenes.org/about-neonatal-diabetes/>>. Acesso em 04 de maio de 2021.

1.5.4.2 Diabetes *mellitus* sindrômico mitocondrial

O genoma mitocondrial humano possui 37 genes, 13 genes que atuam como subunidades de complexos enzimáticos que formam o sistema de fosforilação oxidativa, 2 genes responsáveis pela produção de duas moléculas de RNA ribossomal (RNAr) e 22 moléculas de RNA transportador (RNAt) (54–56). O DNA mitocondrial (DNAm_t) possui herança materna e pode estar presente em homoplasia ou heteroplasmia, ou seja, no caso da homoplasia todas as mitocôndrias de uma mesma célula possuem DNAm_t iguais e no caso da heteroplasmia, uma mesma célula possui mitocôndrias com genoma mitocondrial diferentes (57,58). O gene *mitochondrially encoded tRNA leucine 1* (UUA/UUG) (*MT-TL1*; OMIM *590050) codifica o RNAt de leucina, e a variante m.3243A>G neste gene é descrita associada à síndrome da encefalopatia mitocondrial, acidose láctica e episódios de derrames, denominada MELAS (do inglês “mitochondrial encephalopathy, lactic acidosis, and stroke-like episodes”; OMIM #540000) (49). Entretanto, estudos posteriores mostraram que a maioria dos pacientes que eram portadores desta variante não possuía diagnóstico clínico de MELAS. Esta síndrome afeta aproximadamente 15% de todos os pacientes com a variante m.3243A>G (59). Essa variante também é associada ao diabetes e surdez de herança materna (MIDD, do inglês “maternally inherited diabetes and deafness”; OMIM #520000) e à oftalmoplegia externa progressiva crônica (PEO, do inglês “progressive external ophthalmoplegia”; OMIM #157640) (60,61). Estudos em populações Caucasianas estimam que a prevalência da m.3243A>G gira em torno de 140 a 250 indivíduos por 100 mil (62,63), enquanto a prevalência encontrada para doenças mitocondriais em portadores da m.3243A>G é de 3,5 em 100 mil indivíduos (57). Esses números indicam que muitos carreadores desta variante são assintomáticos ou oligossintomáticos, podendo apresentar sintomas leves ou poucos sintomas ao longo da vida e podendo afetar diversos órgãos, sendo de difícil diagnóstico para os clínicos (64). Além disso, outros fatores atuam como complicadores no diagnóstico clínico, como a variabilidade clínica entre os portadores da variante, variação na razão do número de cópias de DNAm_t mutado e selvagem por célula, e mesmo em diferentes tecidos (65,66). Manifestações clínicas como baixa estatura e presença de perda de audição neurosensorial com herança materna devem apontar para suspeita clínica de doença mitocondrial (66–68). Com relação ao tratamento, a maioria dos pacientes inicialmente não é dependente de insulina, sendo tratados com sulfonilureias (69). O diagnóstico molecular auxilia na identificação destes pacientes e pode ser feito através da análise de diferentes tecidos, sendo mais indicada a coleta de sangue ou urina por serem menos invasivos, entretanto tem que se levar em consideração que há a possibilidade da presença de

heteroplasmia, além da variação na razão de DNAm_t mutado e selvagem em diferentes tecidos (66,70,71) (**Figura 3**).

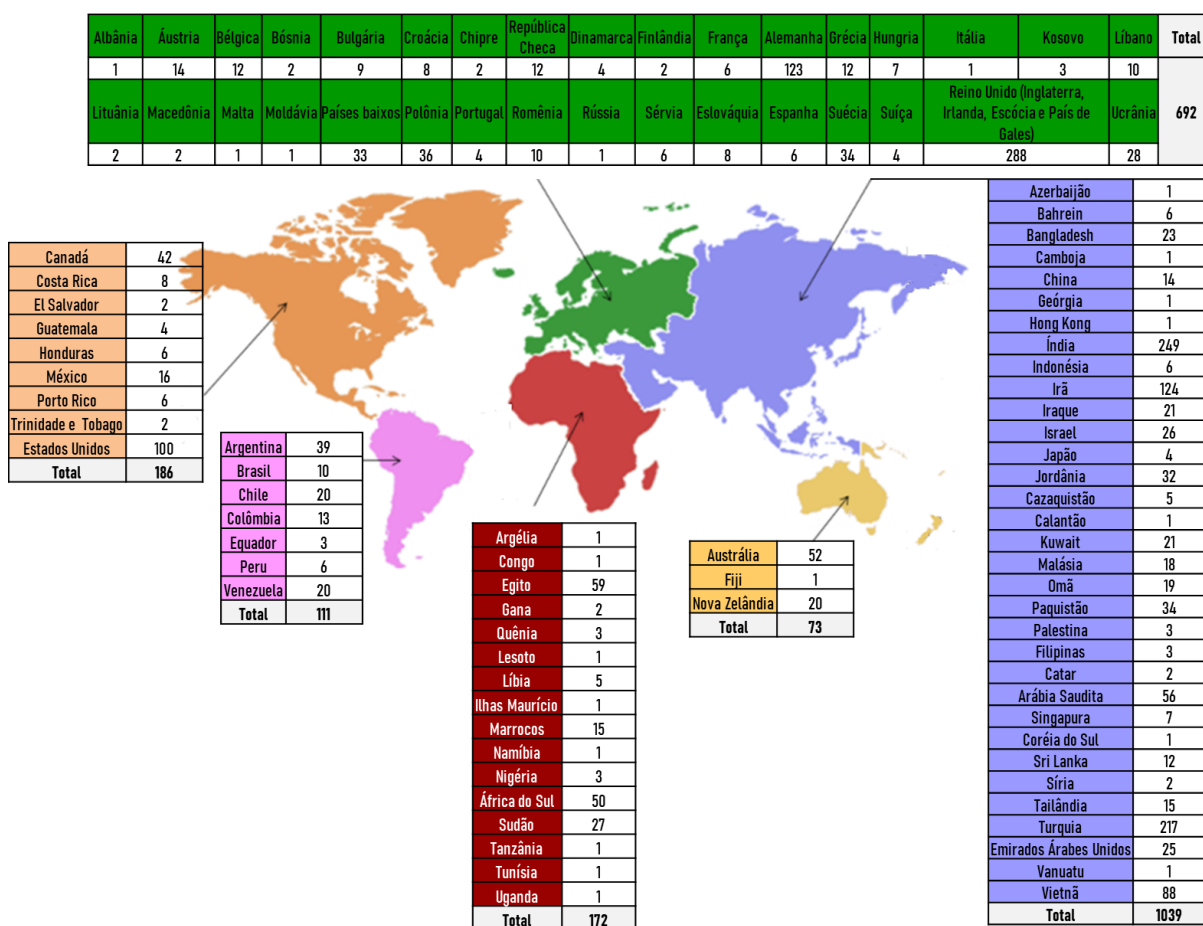

Figura 3. Doenças relacionadas à variante m.3243A>G no gene mitocondrial *MT-TL1*, e seus fatores moduladores. Uma única célula humana pode conter mitocôndrias com DNAmT em homoplasma (verde) ou em heteroplasma (vermelho), ainda, uma mitocôndria pode conter DNAmT mutado (vermelho) e selvagem (verde). A mutação m.3243A>G está presente no gene *MT-TL1* que codifica o RNAt de leucina (A). O fenótipo observado nos indivíduos portadores da mutação m.3243A>G dependerá de vários fatores (B). Os sintomas clínicos dos pacientes são heterogêneos e são influenciados pelo grau de heteroplasma e pelos moduladores do fenótipo (C). **Fonte:** O autor, Adaptado de (66).

1.5.4.3 Maturity-Onset Diabetes of the Young

“Maturity-Onset Diabetes of the Young” (MODY) é classicamente caracterizado com uma idade de manifestação de diabetes geralmente antes dos 25 anos de idade, herança mendeliana autossômica dominante e um defeito primário nas células β -pancreáticas. MODY é uma condição clínica e geneticamente heterogênea, com apresentação clínica variável entre indivíduos com o mesmo tipo genético de MODY e mesmo entre membros de uma mesma família (48). Até o momento, já foram descritas 14 formas de MODY. Mutações nos genes *GCK*, *HNF1A*, *HNF4A*, *HNF1B* respondem por cerca de 80% dos casos de MODY, sendo alterações nos genes *PDX1*, *NEUROD1*, *KLF11*, *CEL*, *PAX4*, *INS*, *BLK*, *ABCC8*, *KCNJ11* e *APPL1* consideradas causas raras (< 1%) no diagnóstico de MODY (**Tabela 1**).

Tabela 1. Formas de diabetes *mellitus* do tipo Maturity-Onset Diabetes of the Young.

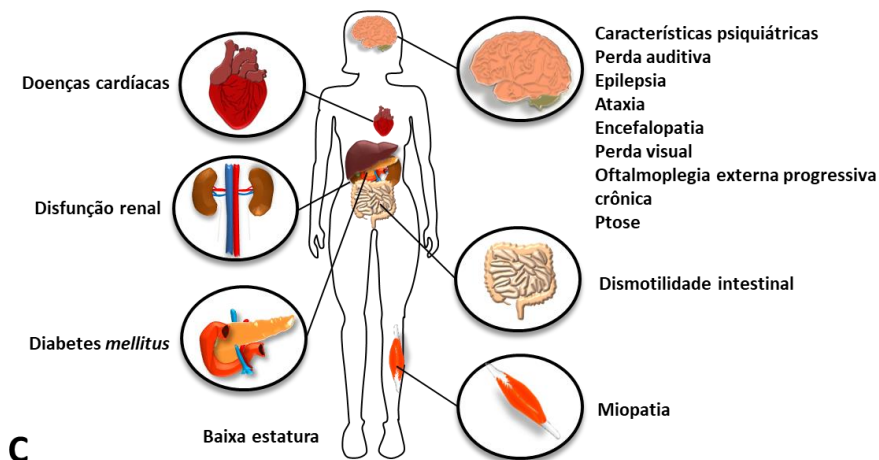
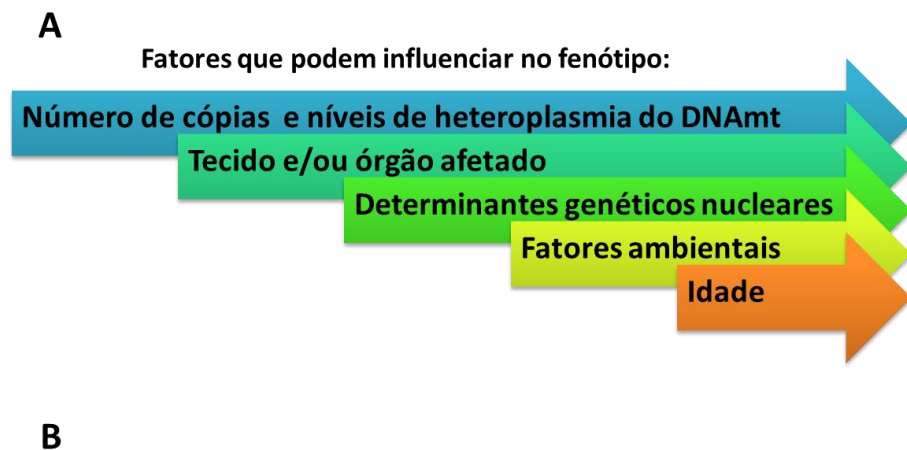
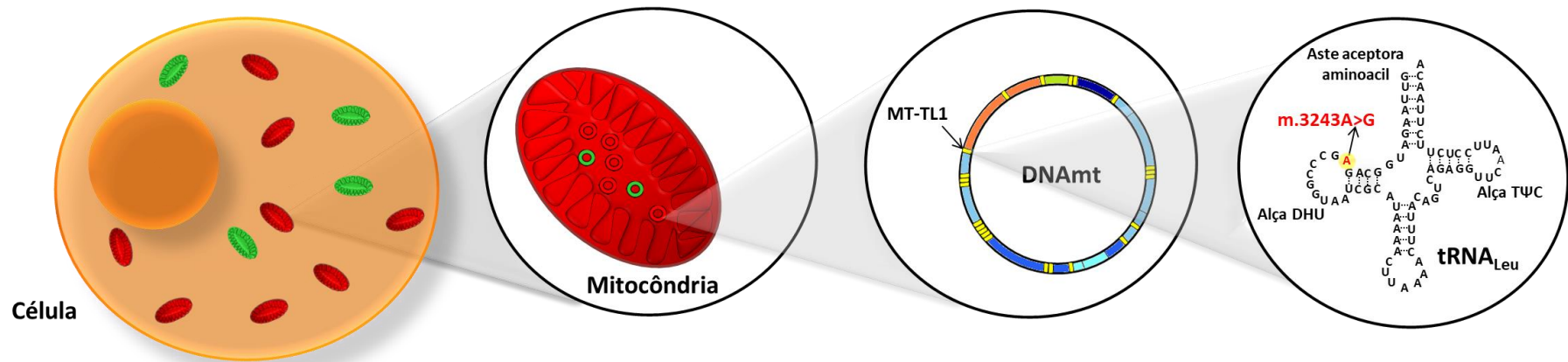
Subtipo	Gene	Locus	Função do gene	Freq.	Fisiopatologia	Características	Tratamento	Ref.
MODY1	<i>HNF4A</i>	20q13	Fator de transcrição	5%	Disfunção da célula-β	Hiperinsulinismo durante a infância, baixos níveis de triglicerídeos	Sulfonilureia	(72)
MODY2	<i>GCK</i>	7p13	Enzima do primeiro passo do metabolismo da glicose	15-25%	Disfunção da célula-β	Hiperglicemia leve de jejum	Sem medicação, dieta	(73)
MODY3	<i>HNF1A</i>	12q24	Fator de transcrição	30-50%	Disfunção da célula-β	Glicosúria	Sulfonilureia	(74,75)
MODY4	<i>PDX1</i>	13q12.2	Fator de transcrição	<1%	Disfunção da célula-β	Agenesia pancreática em homozigotos/heterozigotos compostos	Dieta ou medicamento oral ou insulina	(76)
MODY5	<i>HNF1B</i>	17q12	Fator de transcrição	5%	Disfunção da célula-β	Anomalias renais, anomalias genitais, hipoplasia pancreática	Insulina	(77,78)
MODY6	<i>NEUROD1</i>	2q31	Fator de transcrição	<1%	Disfunção da célula-β	Diabetes neonatal, anormalidades neurológicas em homozigotos	Medicamento oral ou insulina	(79)
MODY7	<i>KLF11*</i>	2p25	Fator de transcrição	<1%	Disfunção da célula-β	Similar ao diabetes do tipo 2	Medicamento oral ou insulina	(80)
MODY8	<i>CEL</i>	9q34	Controle exócrino e endócrino do pâncreas	<1%	Disfunção do pâncreas endócrino e exócrino	Disfunção exócrina, lipomatose	Medicamento oral ou insulina	(81)
MODY9	<i>PAX4*</i>	7p32	Fator de transcrição	<1%	c	Possível cetoacidose	Dieta ou medicamento oral ou insulina	(82)
MODY10	<i>INS</i>	11p15	Codifica o precursor proinsulina	<1%	Variante no gene da insulina	Diabetes <i>mellitus</i> neonatal permanente	Dieta ou medicamento oral ou insulina	(83,84)
MODY11	<i>BLK*</i>	8p23.1	Função de tirosina quinase na transdução do sinal	<1%	Defeito na secreção da insulina	Sobrepeso	Dieta ou medicamento oral ou insulina	(85)
MODY12	<i>ABCC8</i>	11p15	Regula a liberação da insulina	<1%	Disfunção no canal de potássio sensível a ATP	Diabetes <i>mellitus</i> neonatal permanente ou transitória	Sulfonilureia	(86)
MODY13	<i>KCNJ11</i>	11p15.1	Regula a liberação da insulina	<1%	Disfunção no canal de potássio sensível a ATP	Diabetes neonatal em homozigose	Medicamento oral ou insulina	(87)
MODY14	<i>APPL1</i>	3p14.3	Via de sinalização da insulina	<1%	Defeito na secreção da insulina	Fenótipo dismórfico, diminuição no desenvolvimento	Dieta ou medicamento oral ou insulina	(88)
-	<i>RFX6#</i>	6q22.1	Fator de transcrição	-	Disfunção da célula-β	Penetrância reduzida para diabetes	Dieta ou medicamento oral ou insulina	(89)

Em negrito e vermelho estão sinalizados os genes rastreados neste estudo. Freq: frequência; Ref: referências. *Os genes *KLFI1*, *PAX4* e *BLK* apesar de classificados como genes MODY, recentemente têm sido discutido os seus papéis na causa de MODY, Clinical Genomic Resource (ClinGen, <https://search.clinicalgenome.org/kb/affiliate/10016?page=1&size=25&search=>, Acesso em 07 de Julho de 2021 às 10:36) (90). # Foram descritas variantes com perda de função no gene *RFX6* implicadas em fenótipo clínico semelhante ao apresentado pelos pacientes com MODY, mas as modificações apresentaram baixa penetrância **Fonte:** O autor, Adaptado de (89,91–93).

1.6. Genética do diabetes *mellitus*

Já foram descritos mais de 50 *loci* envolvidos na suscetibilidade genética ao DM do tipo 1, sendo a região HLA (do inglês “Human Leukocyte Antigen”) no cromossomo 6 responsável pelo maior risco para o desenvolvimento desta doença, enquanto genes presentes fora desta região contribuem de forma mais modesta (94,95). Enquanto para o DM do tipo 2, já foram identificados mais de 100 *loci* associados ao aumento de risco dessa doença, entretanto eles explicam apenas cerca de 10% a 15% da predisposição (96). Os genes *INS*, *RASGRP*, *COBL*, *RNLS* e *BCAR1* já foram descritos associados à ambas formas. Mais de 2/3 dos genes candidatos a MODY estão associados ao DM do tipo 2. Os genes *SLC2A2* e *WFS1* e *GLIS3* foram descritos associados ao diabetes neonatal e também ao diabetes do tipo 2 e tipo 1, respectivamente (48) (**Figura 4**).



Figura 4. Diagrama de interseção entre genes associados ao diabetes poligênico e monogênico. **Fonte:** O autor, Adaptado de (48).

1.7 Critérios clínicos utilizados para inclusão no estudo de formas monogênicas do DM

O diagnóstico das formas monogênicas é feito a partir das características clínicas apresentadas pelos pacientes, além de informações prévias do probando e de seus familiares. É de extrema importância a confirmação do diagnóstico clínico através do rastreamento molecular do gene suspeito. Quando comprovado o diagnóstico através da identificação de mutações patogênicas em um dos genes associados às formas monogênicas, o médico responsável poderá optar pelo tratamento mais adequado para cada um dos subtipos. O **fluxograma 2** mostra as características fenotípicas, genes estudados e principais escolhas farmacológicas para os principais subtipos monogênicos.

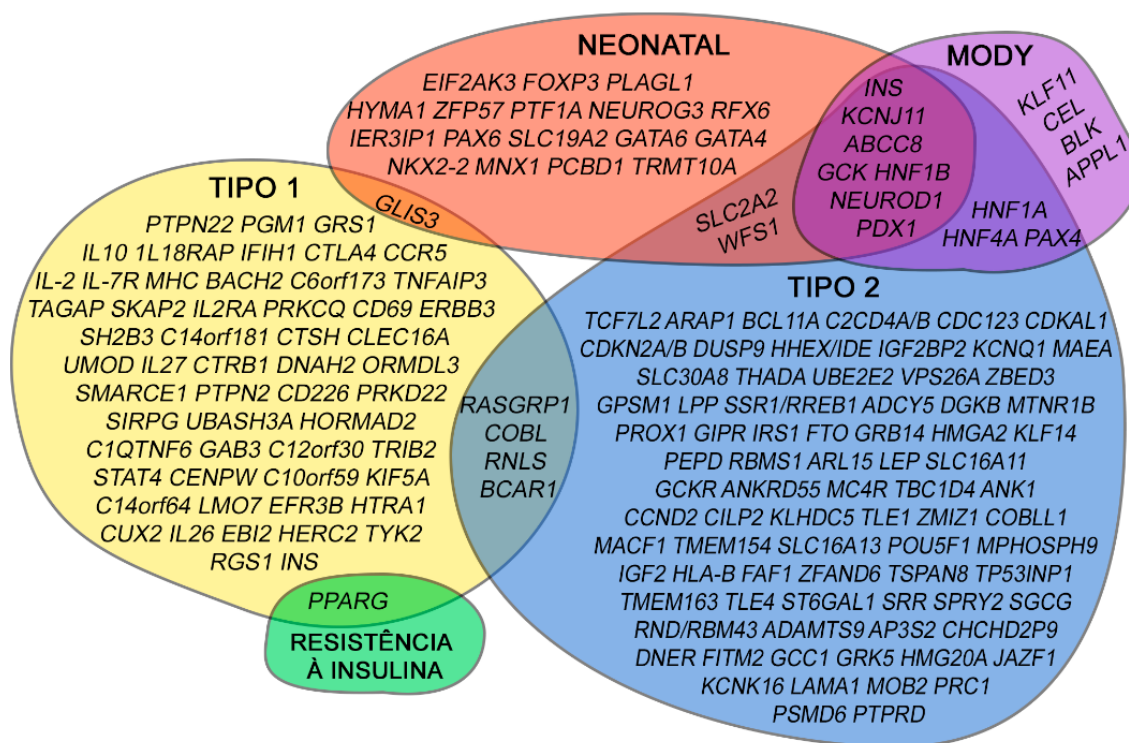
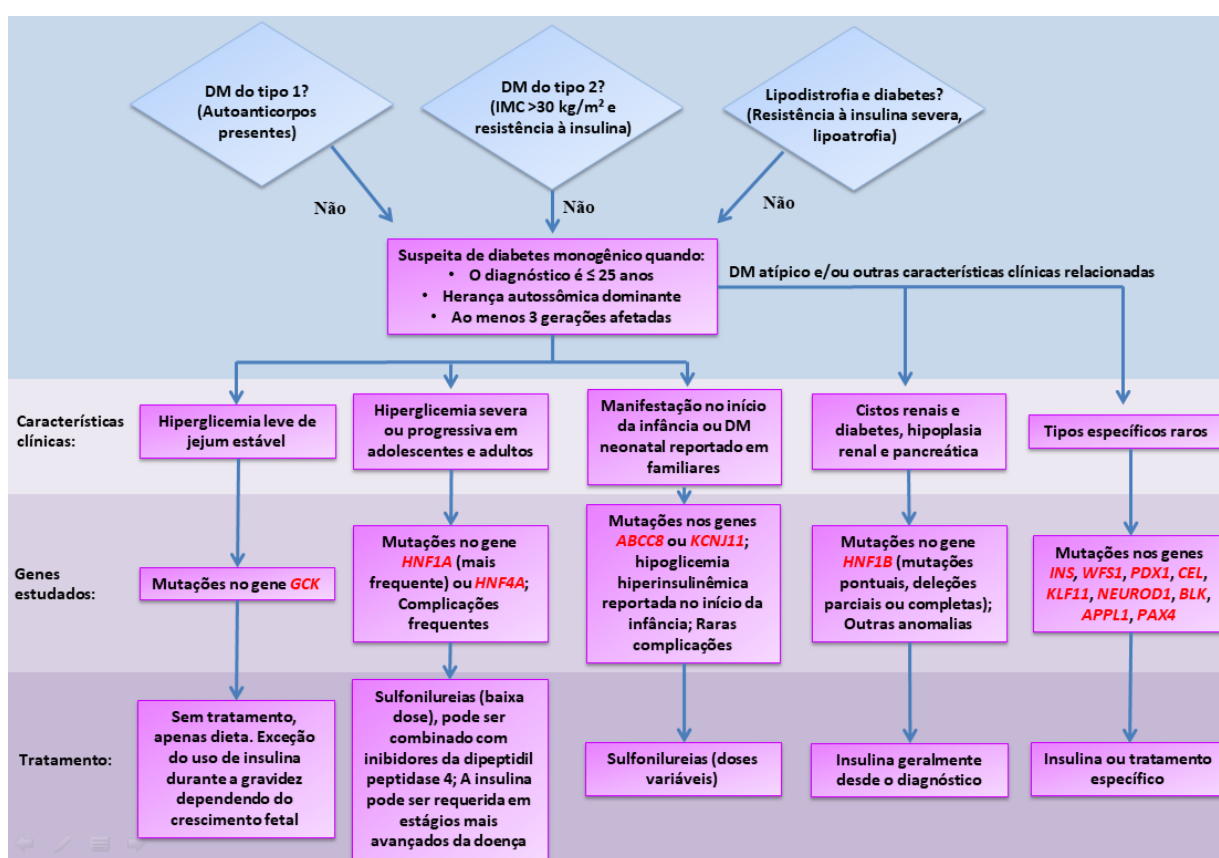

Fluxograma 2. Critérios de diagnóstico e características clínicas e recomendações terapêuticas dos principais tipos de diabetes monogênico. **Fonte:** O autor, Adaptado de (97).

1.8 Formas comuns de diabetes do tipo MODY

1.8.1 Modificações no gene *GCK* associadas ao diabetes monogênico

Mutações nos genes *Glicoquinase (GCK)* e *HNF1 homeobox A (HNF1A)*, são as causas mais frequentes de MODY no mundo. As frequências das mutações irão variar de acordo com o background genético, e principalmente devido aos critérios utilizados na seleção e avaliação dos pacientes, visto que estes apresentam quadros clínicos bem diferentes. Estudos com enfoque em crianças, geralmente encontram uma frequência maior de GCK-MODY (98). Um estudo em grande amostra populacional no Reino Unido descreveu uma frequência de 32% para pacientes com mutações no gene *GCK* (GCK-MODY) e 52% de pacientes com mutações no gene *HNF1A* (HNF1A-MODY) (45).

Em 2009, na última grande revisão de modificações identificadas no gene da glicoquinase, 620 modificações já haviam sido descritas em 1.441 famílias com MODY, HHPI ou DMNP. As modificações (de sentido trocado, sem sentido, que altera o quadro de leitura, e nos sítios de encadeamento) se encontraram distribuídas ao longo dos 10 éxons. Não foram observados “pontos quentes”, entretanto, 255 das 620 modificações estavam presentes em mais de uma família (99). Grandes deleções parciais ou completas são raras no gene *GCK*, não havendo casos até o momento descritos no Brasil (100–103). Um levantamento feito pelo “Brazilian Monogenic Diabetes Study Group” (BRASMOD) com dados publicados para MODY no Brasil, descreveu 72 pacientes de 28 famílias com alterações no gene *GCK*, sendo as mais frequentes, majoritariamente, representadas pelas modificações de sentido trocado (75%), seguidas por pequenas inserções/deleções (10,7%), modificações dos tipos sem sentido (7,15%), e nos sítios de encadeamento (7,15%) (104).

1.8.1.1 O gene *GCK*

O gene *GCK* (OMIM *138079) possui 45.165 pares de bases (pb), 10 éxons e localiza-se em 7p15.3-p15.1. O gene *GCK* codifica a proteína glicoquinase de 465 aminoácidos (105,106). Essa proteína consiste em um único domínio hexoquinase que possui dobras α e β que se dobram para formar dois subdomínios, um maior (aminoácidos 204-443) e um menor (aminoácidos 67-203) (107) (**Figura 5**).



Figura 5. Representação do gene *GCK* e dos domínios da proteína glicoquinase. Na figura estão representados os 10 éxons do gene. O íntron 1 é o maior de todos, possuindo 35.445 pares de bases e está fora da escala (linha pontilhada). As regiões não traduzidas 5' e 3' estão apresentadas em cinza. Transcrito NM_000162.5. **Fonte:** O autor.

1.8.1.2 A via metabólica da enzima glicoquinase

A enzima glicoquinase é expressa nas células β -pancreáticas e no fígado. Nas células- β essa enzima funciona como um sensor de glicose com indução para secreção de insulina (108,109). Durante a fase pós-prandial, período onde ocorre o aumento na glicose sanguínea, a glicose entra nas células β -pancreáticas através dos transportadores de glicose de isoforma 2 (GLUT2) (109). Dentro da célula- β , a glicose é fosforilada no sexto carbono de sua molécula através da enzima glicoquinase, formando glicose-6-fosfato; este produto formado é essencial para inibição das isoenzimas de hexoquinases (109–111). Após esta etapa, ocorre a glicólise e o metabolismo oxidativo que aumentam a razão de ATP/ADP, levando à inativação dos canais de potássio (K^+_{ATP}) formados pelas subunidades SUR1/Kir6.2, codificadas pelos genes *ABCC8* e *KCNJ11*, respectivamente. Em seguida, ocorre a despolarização da membrana plasmática e subsequente abertura dos canais de cálcio (Ca^{2+}), sensíveis à voltagem, e ocorre o aumento do influxo de cálcio para a célula. O aumento dos Ca^{2+} livres no citosol levam à exocitose das vesículas contendo o hormônio de insulina na corrente sanguínea (112–115). Nas células adiposas e musculares a insulina estimula a translocação do transportador GLUT4 presentes nas vesículas de armazenamento, para as membranas plasmáticas, estimulando assim a captação de glicose nestes órgãos (115,116).

Durante o período pós-prandial, a glicoquinase presente no fígado atua na fosforilação da glicose para produção e estoque de glicogênio, e não como fonte de energia como ocorre nas células β -pancreáticas. Durante o período de jejum, quando a concentração de glicose é baixa e, conseqüentemente, ocorre a diminuição do estoque de glicogênio, a enzima glicoquinase é deslocada para o núcleo e inativada pelo seu ligante, a proteína reguladora da glicoquinase (GRP, do inglês “glucokinase regulatory protein”) (117–120). Quando ocorre a reexposição à comida, a glicoquinase é liberada do seu ligante GRP no núcleo, retomando sua forma ativa no citosol (119–121) (**Figura 6**).

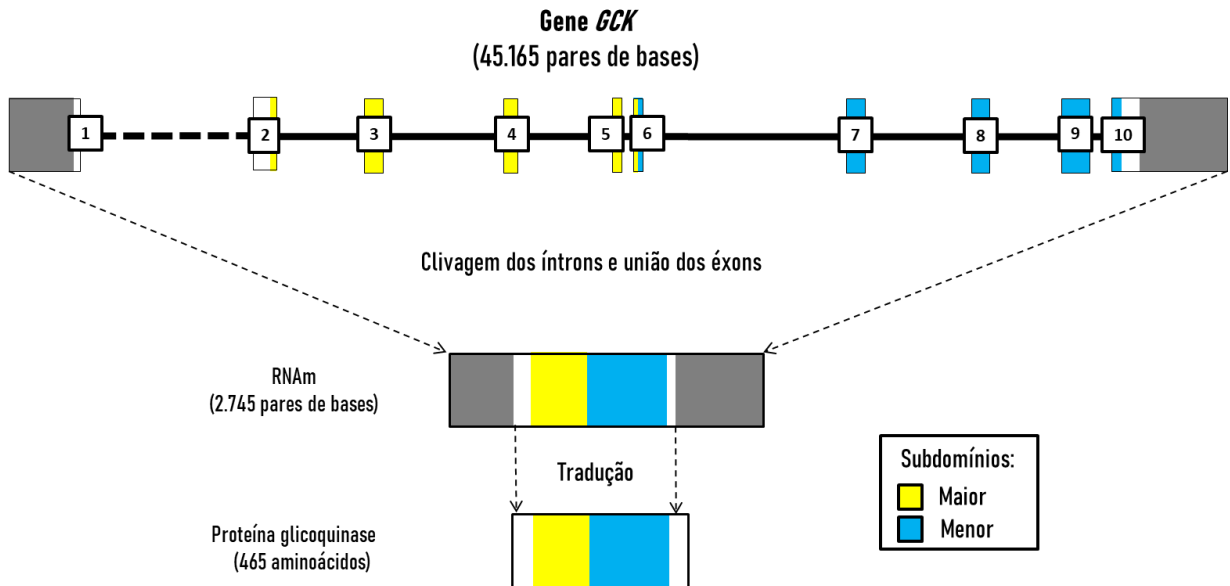

Figura 6. Via metabólica da enzima glicoquinase. G6P: Glicose-6-fosfato; GKb: glicoquinase presente na célula- β ; GKf: glicoquinase presente no fígado; GLUT2: transportadores de glicose de isoforma 2; GLUT4: transportadores de glicose de isoforma 4. **Fonte:** O autor, Adaptado de (115).

1.8.1.3 Resposta biológica a modificações estruturais na enzima glicoquinase

Estudos matemáticos sugerem que o limiar para a liberação de insulina estimulada por glicose (LIEG) é alcançado quando a capacidade de fosforilação da glicose pela enzima glicoquinase é cerca de 25% do máximo e isso ocorre quando a concentração plasmática de

glicose é de aproximadamente 5 mmol/l (90 mg/dL) em indivíduos sem alterações no gene glicoquinase (122). Mutações no gene *GCK* podem levar a quadros de hipoglicemia e hiperglicemia, sendo o último mais comum. Mutações em heterozigose no gene *GCK*, que inativem essa enzima, levam ao diabetes do tipo GCK-MODY. Essas alterações enzimáticas nas células- β mudam o limiar da LIEG, elevando moderadamente para uma média de 6,5 a 7,5 mmol/l (117mg/dL a 135 mg/dL) (123,124). No fígado, levará a uma redução na síntese de glicogênio e estocagem, além do aumento da gliconeogênese após as refeições (125). Mutações inativadoras em homozigose ou em heterozigose composta no *GCK* levam a um quadro severo de DMNP presente desde o nascimento. Nestes pacientes o limiar da LIEG será infinitamente alto devido à total inativação da enzima (124,126,127). Já mutações ativadoras com ganho de função neste gene causam HHPI e há redução no limiar podendo chegar a 0,8 mmol/l (14,41 mg/dL) (128,129) (**Figura 7**).

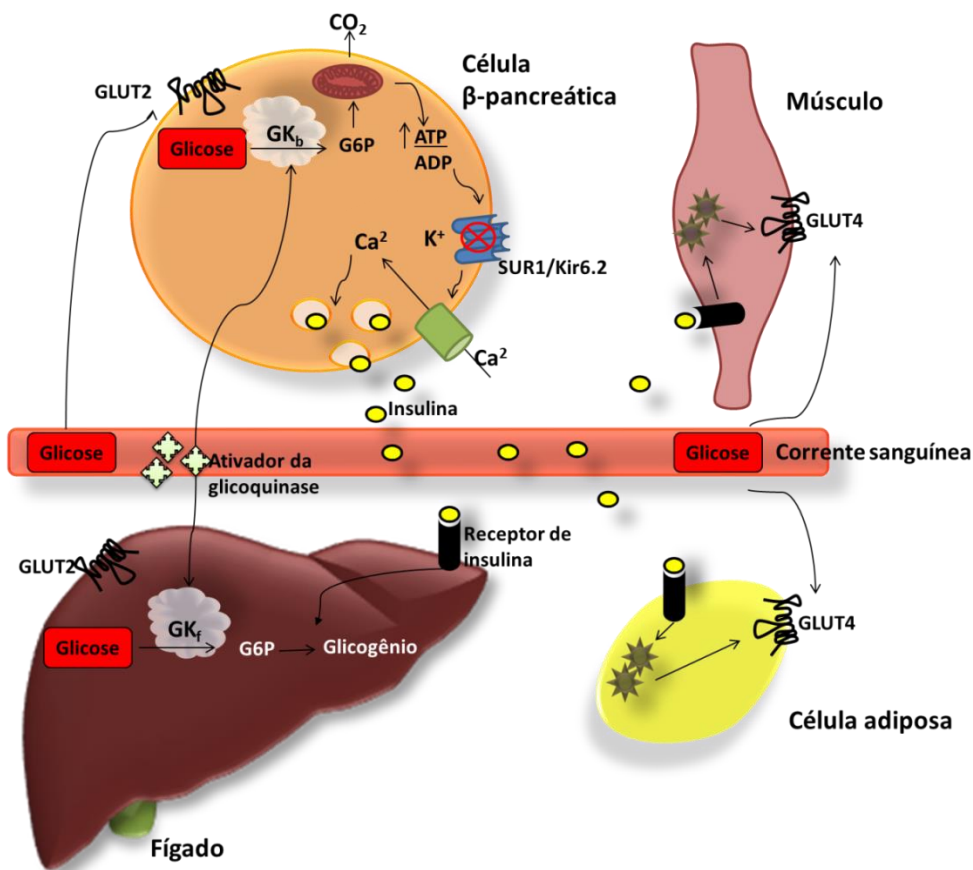

Figura 7. Efeito de mutações na proteína glicoquinase na modificação do limiar para secreção de insulina estimulada pela glicose. HHPI: hipoglicemia hiperinsulinêmica persistente de infância. **Fonte:** Modificado de (130).

1.8.1.4 Características clínicas e controle glicêmico dos pacientes GCK-MODY

Pacientes GCK-MODY (MODY2; OMIM #125851) com mutações inativadoras em heterozigose possuem hiperglicemia leve desde o nascimento, são assintomáticos (131) e apresentam a glicemia de jejum normalmente na faixa de 5,6 a 8,0 mmol/l (100-144 mg/dl) e

HbA1c de 5,6% a 7,3% (132). Visto que os valores de HbA1c são próximos da faixa do normal e complicações micro e macrovasculares são raras (133), estes pacientes são frequentemente subdiagnosticados e são detectados normalmente em exames de rotina. Esta é uma das razões para que a herança autossômica dominante não seja evidente em muitas famílias com diabetes GCK-MODY (134). Quando os pacientes com GCK-MODY são detectados em exames de rotina ou mesmo em exames durante a gravidez, eles frequentemente são diagnosticados erroneamente com DM tipo 1 (135). Visto que os pacientes com GCK-MODY apresentam uma leve hiperglicemia e raramente possuem complicações do diabetes, não se recomenda tratamento farmacológico para estes pacientes, já que há apenas um mínimo efeito na glicemia deles, então se aconselha o controle glicêmico apenas através de dieta nutricional e exercícios físicos (136).

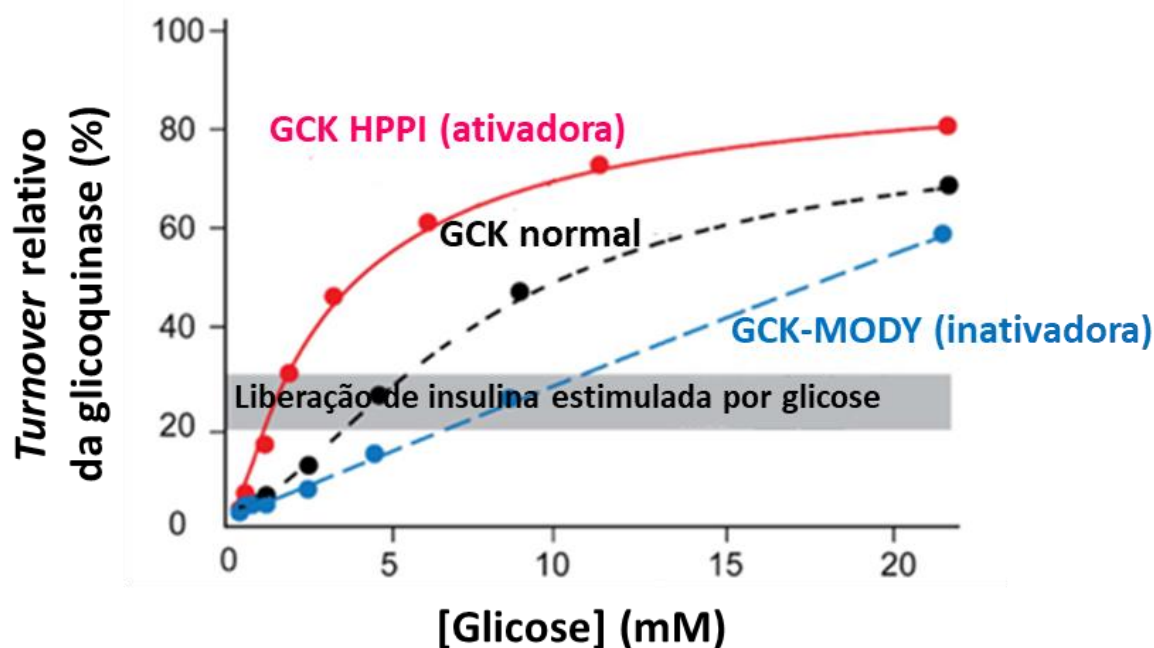
1.8.1.5 GCK-MODY e a gravidez

Uma exceção no controle glicêmico é durante o período de gravidez; se o bebê não herdar a variante inativadora presente no gene *GCK* da mãe, ele secretará mais insulina para se adaptar à hiperglicemia materna. A maior captação de glicose causará um aumento do risco de desenvolver macrossomia, resultando em um acréscimo de cerca de 700 gramas na média do peso ao nascimento. Neste caso, recomenda-se o tratamento com insulina durante a gravidez para reduzir a hiperglicemia materna. Por outro lado, se o bebê herdar a variante inativadora do pai, e a mãe for normal para mutações no *GCK*, ele terá uma redução na liberação da insulina resultando em diminuição do peso de nascimento em aproximadamente 500 gramas. No caso do bebê herdar a variante inativadora da mãe com GCK-MODY, não há alteração do peso de nascimento, visto que a função enzimática da glicoquinase se comportará de forma igual à resposta da hiperglicemia da mãe; neste caso não é recomendado o tratamento com insulina, visto que isto pode levar à diminuição do peso fetal (137,138). O acompanhamento de mulheres com risco de gestar bebês com macrossomia devido a mutações em genes associados às formas monogênicas deve ser realizado através de ultrassonografias periódicas a partir da 26^a semana de gestação. Este acompanhamento é feito para identificar sobrepeso fetal e para decidir se o parto desta gestante deverá ser adiantado através de indução na 38^a semana ou ainda se necessitará ser feita a cesárea.

Recentemente, Caswell e colaboradores (2020) reportaram a aplicação do teste pré-natal não invasivo (NIPT, do inglês “Noninvasive prenatal testing”) do DNA fetal livre de células (cffDNA, do inglês “Cell Free Fetal DNA”) em gestantes com mutações do tipo de sentido trocado ou indels no gene *GCK* ou *HNF4A*. Para isso, eles coletaram 20 ml de sangue

periférico materno e utilizaram a técnica de “droplet digital PCR” (ddPCR) a qual identifica a presença de baixos níveis de DNA através de sondas alelo-específico. Este modelo se mostrou promissor na identificação pré-natal de variantes patogênicas nos genes *GCK* e *HNF4A* nos bebês, que poderá ter grande impacto no manuseio terapêutico de gestantes com mutações nestes genes (139).

1.8.2 Modificações no gene *HNF1A* associadas ao diabetes monogênico

Mutações no gene *HNF1A* são as principais causas de MODY em adultos (45,140). Colclough e colaboradores, em um levantamento bibliográfico de modificações previamente descritas até 2013 no gene *HNF1A*, descreveram 414 diferentes modificações em 1.247 famílias. As modificações de sentido trocado foram as mais frequentes (54,7%), seguidas das que alteram o quadro de leitura (21,7%), sem sentido (9,4%), modificações em sítios de encadeamento (8,7%), modificações em regiões promotoras (1,9%), deleções “in frame”, deleções, inserções ou duplicações de aminoácidos (2,4%) e mais raramente deleções parciais ou totais do gene (1,2%). As modificações se distribuíram ao longo dos 10 éxons, entretanto, foram mais comumente encontradas nos éxons 2 e 4 (140). No Brasil, até 2017, o BRASMOD havia contabilizado 31 pacientes de 18 famílias HNF1A-MODY. Apesar de neste levantamento modificações no gene *GCK* terem sido mais frequentes que no *HNF1A*, os autores alertaram para os critérios de seleção dos pacientes nos diferentes estudos que podem ter influência nas frequências encontradas (104). As descrições de deleções parciais e totais do gene são raras e não identificadas no Brasil até o momento (100,103,141).

1.8.2.1 O gene *HNF1A*

O gene *HNF1 homeobox A* (*HNF1A*; OMIM *142410) mapeia em 12q24.31, possui 10 éxons e codifica o fator de transcrição HNF1A composto por três domínios: 1) O domínio N-terminal de dimerização (resíduos 1-32); 2) O domínio de ligação ao DNA (DBD, do inglês “DNA-binding domain”), que possui dois subdomínios, o POU domínio específico (POUs) (resíduos 82-172) e o POU homeodomínio (POUh) (resíduos 198-281). Além disso, no domínio de ligação se encontra o sinal de localização nuclear (NLS, do inglês “Nuclear localization signal”). O HNF1A se liga ao DNA através do palíndromo invertido 5'-GTTAATNATTAAC-3'. O POUUs tem função na manutenção da estabilidade da proteína enquanto o domínio POUh atua na iniciação da interação do HNF1A com o DNA (142-144); 3) O domínio de transativação se localiza na região C-terminal (resíduos 282-631) (145) (**Figura 8**).



Figura 8. Representação do gene *HNF1A* e dos domínios do fator de transcrição HNF1A. Na figura estão representados os 10 éxons do gene. As regiões não traduzidas 5' e 3' estão apresentadas em cinza. Transcrito NM_000545.8. **Fonte:** O autor.

O local e o tipo de variante presente no *HNF1A* parecem ter papel fundamental na manifestação clínica da doença. Bellanné-Chantelot e colegas (2008) em uma ampla amostra de pacientes HNF1A-MODY observaram que pacientes com mutações que levam à produção de proteínas truncadas manifestaram os sintomas antes daqueles com mutações de sentido trocado. A maior parte das modificações identificadas estava localizada entre os éxons 1-6 que inclui as três isoformas do HNF1A. Os pacientes com mutações de sentido trocado, que afetaram o domínio de dimerização e o domínio de ligação, ou seja, regiões comuns às três isoformas, tiveram a idade de manifestação anterior daqueles com mutações de sentido trocado no domínio de transativação (146). Além disso, a penetrância das mutações no gene *HNF1A* terá um importante papel na manifestação dos sintomas, sendo esta quase completa e associada à idade. Sessenta e três por cento dos pacientes desenvolvem a doença antes dos 25 anos, 79% antes dos 35 anos e 96% antes dos 55 anos de idade (147,148).

O fator de transcrição HNF1A atua como um homodímero recrutando e interagindo com diversos coativadores, que se acoplam ao nucleossomo dando início à modificação em sua estrutura e recrutando a maquinaria necessária para transcrição (149). A estabilidade do dímero de HNF1A é dependente da ligação do dímero do cofator de dimerização do hepatócito nuclear fator 1 (DCoH, do *inglês* “dimerization cofactor of hepatocyte nuclear factor 1”), formando um tetrâmero (144) (**Figura 9**).

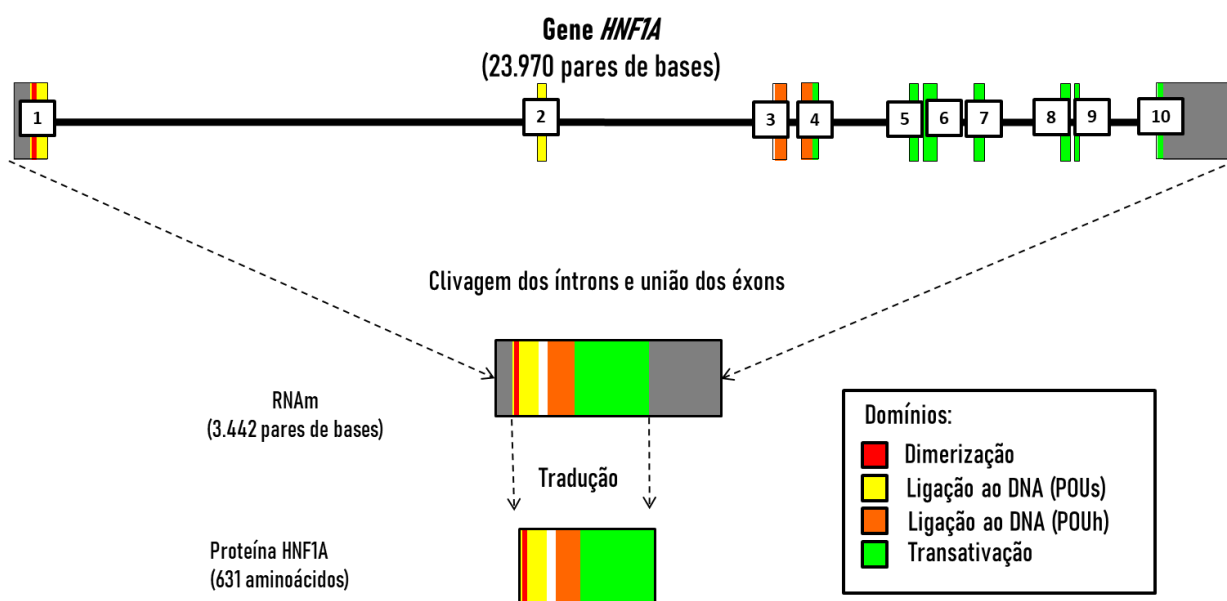

Figura 9. Modelo de ativação do HNF1A. O cofator de dimerização do hepatócito nuclear fator 1 (DCoH) funciona como um dímero (meia lua em amarelo e cinza) e o HNF1A (azul e rosa), inativos no citoplasma (A). O tetrâmero formado pelo dímero de DCoH e HNF1A se localiza no núcleo e se liga ao DNA (B). Quando o DCoH se desassocia do dímero de HNF1A, o desestabiliza (C). Neste momento o DCoH pode se associar novamente ao dímero de HNF1A (B) ou formar um homotetrâmero inativo desestabilizando o dímero de HNF1A (D). **Fonte:** O autor, Adaptado de (144).

O HNF1A se liga ao menos a 222 genes nos hepatócitos humanos, demonstrando seu importante papel na via da gliconeogênese e nas outras vias associadas, além de se ligar também à genes que são centrais na síntese e estoque de carboidratos, no metabolismo de lipídios, detoxificação e síntese de proteínas séricas. Além disso, o HNF1A regula ao menos 106 genes alvos nas ilhotas pancreáticas humanas (150). O HNF1A tem papel fundamental tanto no desenvolvimento de tecidos embrionários quanto na manutenção dos tecidos na vida adulta. Durante o desenvolvimento embrionário, ele é expresso no fígado, na vesícula biliar, no pâncreas, no trato gastrointestinal, nos rins e na bexiga. Já nos tecidos maduros, além desses órgãos, ele também é expresso na medula óssea e no sistema imunológico (151). O HNF1A é um dos fatores de transcrição responsáveis pela regulação dos genes *GLUT2* e do gene da insulina (*INS*) (152,153).

1.8.2.2 Resposta biológica a modificações estruturais no fator de transcrição HNF1A

Alterações que mudem a estrutura ou produção do fator de transcrição HNF1A levam a modificações na secreção da insulina, diminuição na proliferação das células β -pancreáticas e mesmo a ilhotas de Langerhans com estruturas anormais (154–156). Na célula β -pancreática, quando o HNF1A não funciona corretamente, há baixa produção de ATP na célula, com consequente diminuição da liberação de insulina. Enquanto nos rins, o HNF1A participa do

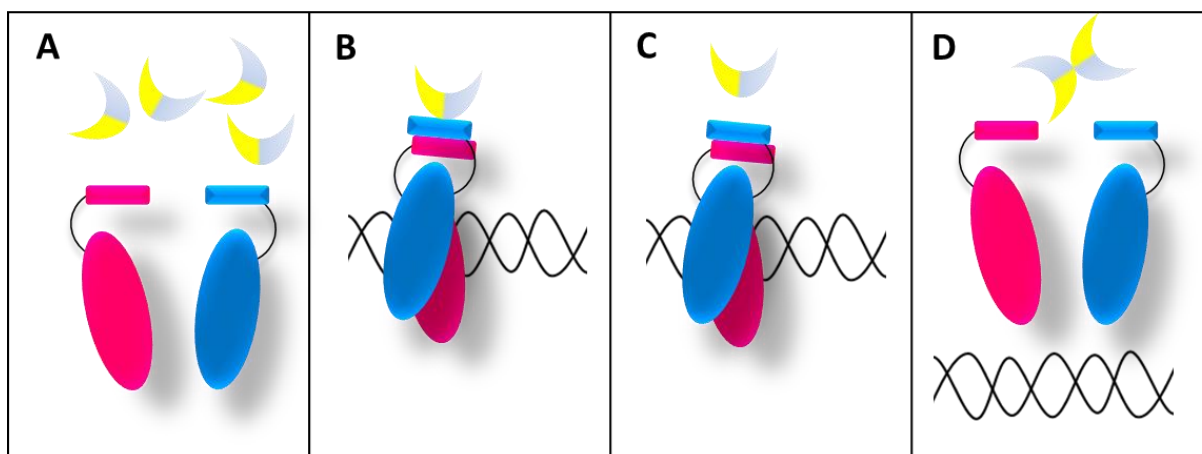
mecanismo responsável pela recaptação da glicose do filtrado glomerular, e quando esta proteína não está funcionando corretamente, os níveis de glicose se mantêm elevados na urina, levando à glicosúria (presença de glicose na urina) (157–159).

1.8.2.3 Características clínicas e controle glicêmico dos pacientes HNF1A-MODY

Pacientes com HNF1A-MODY (MODY3; OMIM #600496) geralmente se apresentam como normoglicêmicos durante a infância, podendo apresentar glicosúria apesar da normoglicemia (159). A diminuição da secreção da insulina é progressiva e o controle glicêmico se deteriora com o tempo. A hiperglicemia geralmente aparece entre a adolescência e início da vida adulta, podendo se manifestar com sintomas como poliúria e polidipsia ou como uma hiperglicemia pós-prandial sem a presença de cetose e cetoacidose (148). Os valores do peptídeo-C são mais baixos quando comparados a indivíduos saudáveis, porém ainda são mais elevados que aqueles dos pacientes com DM do tipo 1 (160). No momento da manifestação da doença há um aumento na glicose plasmática no TOTG de duas horas. Com o decorrer da doença, ocorre falha progressiva da célula β -pancreática, levando ao aumento dos valores da glicose de jejum e deficiência progressiva da liberação de insulina, com alguns pacientes podendo apresentar falha na liberação de insulina com consequente diminuição na detecção do peptídeo-C (161). Pacientes sem controle glicêmico adequado podem apresentar complicações do diabetes, como retinopatia, nefropatia e neuropatia, e mais raramente, hipertensão e doenças cardiovasculares (162,163). Além disso, um marcador que pode ser utilizado como indicativo de pacientes com HNF1A-MODY são os valores obtidos da proteína C-reativa sérica de alta sensibilidade (PCR-as). Pacientes com mutações neste gene apresentam PCR-as expressivamente mais baixo quando comparado às outras formas de diabetes mais comuns (164).

Apesar de mutações no *HNF1A* não parecerem influenciar no peso do nascimento do bebê, como no caso de mutações no *GCK*, filhos de mulheres com HNF1A-MODY parecem manifestar a doença mais precocemente decorrente da exposição à hiperglicemia no útero. Já filhos que herdaram a variante no *HNF1A* através do pai, ou seja, não foram expostos à hiperglicemia materna, tiveram o diagnóstico mais tardiamente (147).

O controle glicêmico de pacientes confirmados para HNF1A-MODY dependerá da evolução da doença. Nos casos em que a HbA1c esteja abaixo de 6,5%, uma dieta pobre em carboidratos pode ser receitada temporariamente. No entanto, com a progressão da doença, medicamentos devem ser iniciados. Pacientes com mutações no gene *HNF1A* possuem uma boa resposta a baixas doses do medicamento oral sulfonilureia de curta-duração (165). A

sulfonilureia, ao contrário do tratamento com insulina exógena, aumenta a secreção da insulina endógena, através do fechamento dos canais de potássio das células- β , permitindo a resposta pancreática espontânea a mudanças nos níveis de glicose (**Figura 10**). Mesmo em pacientes que já haviam iniciado tratamento com insulina previamente ao diagnóstico genético, pode ser feita a troca para a medicação com sulfonilureia com o acompanhamento médico, dependendo da evolução do seu quadro clínico. O tratamento com sulfonilureia geralmente é eficaz durante muitos anos, entretanto, em alguns casos pode ser necessário iniciar o tratamento com insulina naqueles pacientes com diminuição severa na produção de insulina endógena (166).



Figura 10. Funcionamento do canal de potássio nas células- β . Em células normais, durante a homeostase, os canais de potássio encontram-se abertos permitindo a passagem do potássio para o meio extracelular. Em detalhe o canal de potássio formado pelo octâmero contendo um tetrâmero central de Kir6.2, envolto por quatro subunidades de SUR1 (A). Quando há aumento da razão de ATP/ADP, devido à alta concentração de glicose no meio intracelular, ocorre o fechamento dos canais de potássio e abertura dos canais de cálcio que são voltagem dependente e levarão à liberação de insulina (B). Em pacientes com mutações no gene

HNF1A, mesmo em altas concentrações de glicose há pouca liberação da insulina (C). O fármaco sulfonilureia atua estimulando o fechamento dos canais de potássio, possibilitando a liberação da insulina endógena (D). **Fonte:** O autor. Adaptado de (167).

1.8.3 Modificações no gene *HNF4A* associadas ao diabetes monogênico

Mutações no gene *Hepatocyte Nuclear Factor 4-Alpha (HNF4A)* representam a terceira causa mais frequente de diabetes do tipo MODY. Estima-se que estas alterações sejam responsáveis por cerca de 5% a 10% de todos os casos (45,98). No levantamento feito por Colclough e colaboradores (2013), 103 modificações no gene *HNF4A* foram identificadas em 173 famílias. As alterações incluíram modificações de sentido trocado (58,3%), seguidas de alteração do quadro de leitura (11,7%), sem sentido (9,7%), modificações no sítio de encadeamento (5,8%), modificações na região promotora (5,8%), deleções do tipo que não alteram o quadro de leitura, inserções e duplicações de aminoácidos (6,8%) e deleções parciais ou totais do gene (1,9%). As modificações foram identificadas ao longo dos 10 éxons do gene, contudo foram mais frequentes nos éxons 7 e 8 (140). No Brasil, modificações neste gene parecem ser raras. Santana e colaboradores (2019) reportaram três pacientes brasileiros com variantes neste gene, uma classificada pelo “American College of Medical Genetics and Genomics” (ACMG) como benigna e duas novas com significado incerto (168).

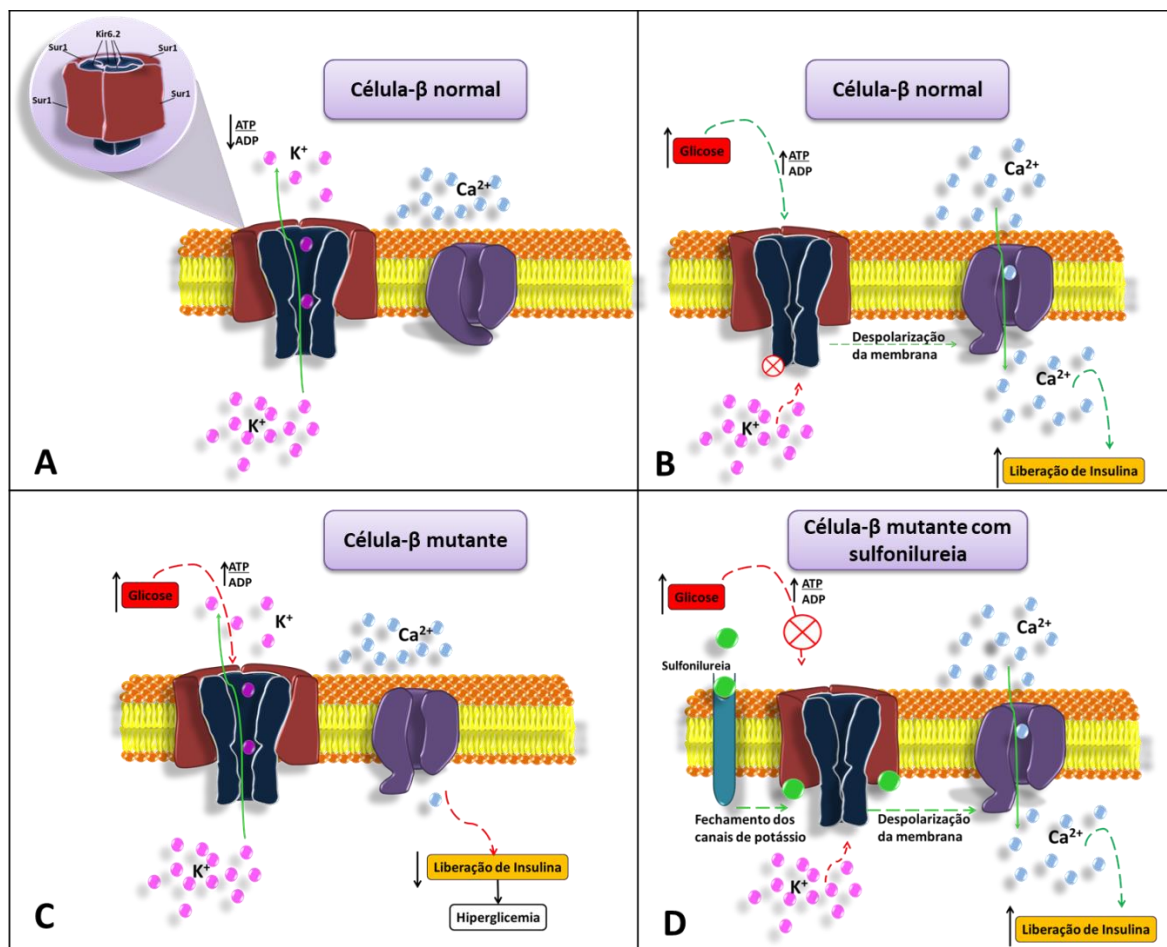
1.8.3.1 O gene *HNF4A*

O gene *HNF4A* (OMIM *600281) possui 10 éxons e localiza-se em 20q13.12 (**Figura 11**). O gene *HNF4A* é membro da superfamília de receptores nucleares (169) contendo o domínio N-terminal com função de ativação 1 (AF-1) (AF, do inglês “activation function”), o domínio de ligação ao DNA (DBD) que inclui dois motivos de zinco, o domínio de ligação ao ligante lipofílico (LBD, do inglês “lipophilic ligand binding domain”), o AF-2 e um domínio extra no C-terminal (domínio F), tem função de repressão (170). A forma ativa do fator de transcrição *HNF4A* atua como homodímero (171), e sua dimerização ocorre através de interações, incluindo interações de zíper de leucina (172). O gene *HNF4A* possui dois promotores (P1 e P2) que são separados por 46 kilobases (kb) (173). O promotor 1 produz as isoformas $\alpha 1$ - $\alpha 6$ através do encadeamento alternativo do éxon 1, podendo conter o éxon 1A ou 1B e através do encadeamento alternativo entre os éxon 9 e 10, podem gerar 3 domínios terminais diferentes (174), enquanto o promotor P2 gera as isoformas $\alpha 7$, $\alpha 8$, $\alpha 9$, $\alpha 10$, $\alpha 11$ e $\alpha 12$ através do encadeamento alternativo do éxon 1, podendo conter o éxon 1D ou 1E e através do encadeamento alternativo da região terminal, assim como ocorre com as isoformas

produzidas pelo promotor 1, gerando isoformas diferentes. As isoformas produzidas pelo promotor P2 são menores e não possuem o fator de ativação 1 (173,175,176). Apenas as isoformas $\alpha 1$, $\alpha 2$ e $\alpha 3$ incluem o domínio AF-1, enquanto os diferentes domínios F são gerados através do encadeamento alternativo que ocorre nos últimos três éxons do gene, resultando em três combinações de C-terminal diferentes. O intestino é o único órgão expressando isoformas expressas pelos promotores P1 e P2. As isoformas $\alpha 1$, $\alpha 2$, $\alpha 3$, $\alpha 7$, $\alpha 8$ e $\alpha 9$ foram observadas no fígado, estômago, intestino delgado e cólon, já a isoforma $\alpha 5$ foi observada exclusivamente no fígado (176).



Figura 11. Representação do gene *HNF4A*. Na figura estão representados os dez éxons do gene e as 12 isoformas diferentes produzidas através dos seus dois promotores representados no esquema pela seta horizontal. Transcrito NM_000457.5. **Fonte:** O autor, Adaptado de (176,177)

O HNF4A é um importante fator de transcrição que participa de diferentes vias metabólicas como nos rins, no desenvolvimento gastrointestinal, na diferenciação hepática e nos metabolismos de lipídios e glicose (177). O HNF4A se liga ao menos a 1.575 genes das células hepáticas e 1.423 nas ilhotas pancreáticas (150). No fígado, o HNF4A controla a expressão de diversos genes, incluindo o *HNF1A* e *HNF1B* (173,174). Além disso, esses três fatores de transcrição em conjunto, controlam o desenvolvimento embrionário. O HNF4A nas

células- β pancreáticas adultas, juntamente com uma maquinaria de transcrição, regula a expressão do transportador GLUT2, tendo papel fundamental na secreção de insulina (178).

1.8.3.2 Características clínicas e controle glicêmico dos pacientes HNF4A-MODY

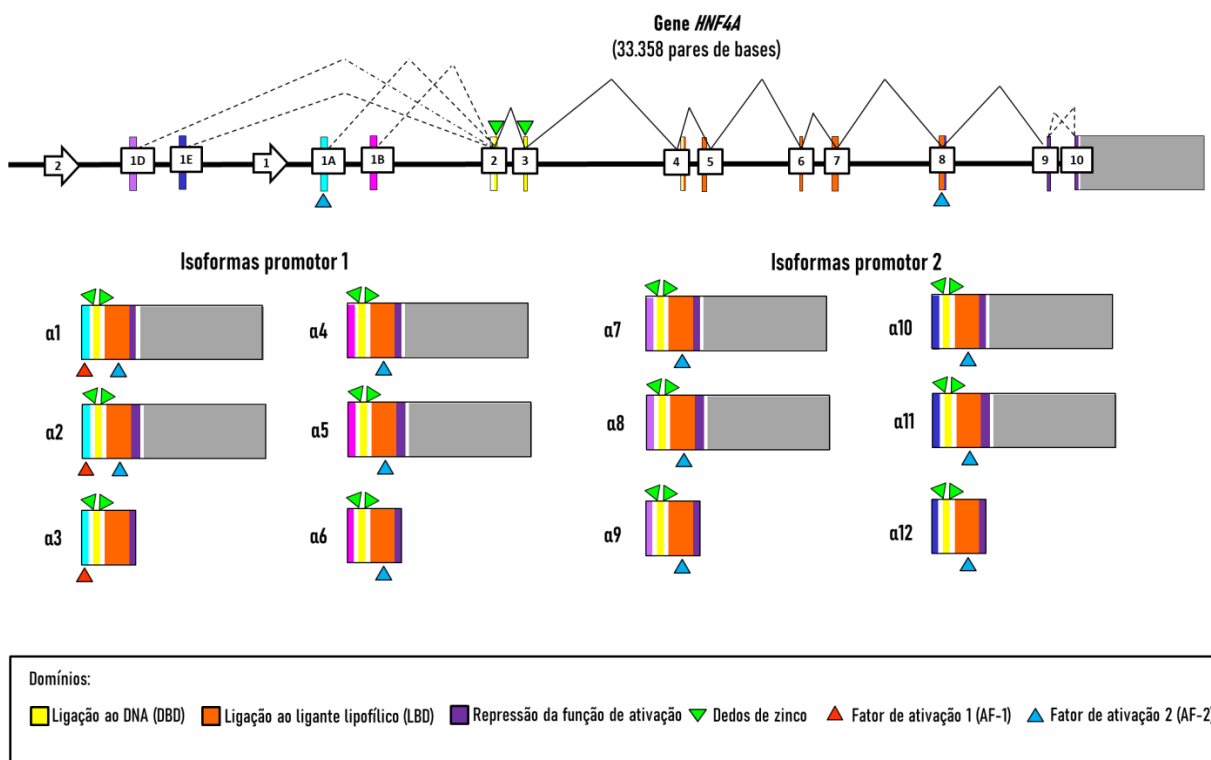
Pacientes com diabetes *mellitus* do tipo HNF4A-MODY (MODY1; OMIM #125850) possuem disfunção pancreática semelhante aos pacientes com a forma HNF1A-MODY, visto que ambos participam da mesma via metabólica (72). Contudo, esses pacientes não apresentam quadro de glicosúria e podem apresentar baixos níveis de apolipoproteínas (apoAII, apoCIII e apoB). Essa alteração nas apolipoproteínas leva a características clínicas extra pancreáticas como níveis reduzidos do colesterol das lipoproteínas de alta densidade (HDL, do inglês “high-density lipoproteins”), baixos níveis de triglicerídeos e altos níveis do colesterol das lipoproteínas de baixa densidade (LDL, do inglês “low density lipoproteins”) (179,180). Além disso, podem apresentar complicações microvasculares, como problemas envolvendo a retina e os rins, assim como pacientes com DM do tipo 1 e do tipo 2 (163).

Pearson e colaboradores (2007) observaram que 56% dos bebês carreadores de modificações em heterozigose no *HNF4A*, independente da herança da variante ter sido materna ou paterna, apresentam macrosomia fetal (peso de nascimento > 4.000 gramas), destes, 15% apresentaram macrosomia fetal extrema (peso de nascimento > 5.000 gramas). Sugere-se o tratamento com insulina prévio à gravidez para mulheres HNF4A-MODY, ou mesmo no final do segundo trimestre da gravidez. Após a vigésima oitava semana de gravidez, o bebê deve ser monitorado de duas em duas semanas através de ultrassom e o parto através de cesárea deve ser pensado durante a 35^a e 38^a semana de gestação. Além disso, 15% dos bebês apresentaram hipoglicemia ao nascimento (181,182). O quadro de hipoglicemia hiperinsulinêmica da infância (HHI) pode ser transiente ou persistente e em geral possui boa resposta ao tratamento com diazóxido (181,183). Ao contrário da sulfonilureia que atua aumentando o fechamento dos canais de potássio para potencializar a liberação de insulina, o diazóxido se liga a estes canais mantendo sua abertura, com consequente diminuição da liberação da insulina pelas células- β pancreáticas (184). Geralmente a HHI melhora durante a infância, com produção diminuída de insulina, progredindo para diabetes na adolescência (183).

Durante a infância e adolescência, quando os níveis de HbA1c estão dentro da faixa do normal, pacientes HNF4A-MODY geralmente possuem um bom controle glicêmico através de dieta de baixo carboidrato (182). Quando a dieta não parece ser suficiente, baixas doses de sulfonilureia são recomendadas, assim como para os pacientes HNF1A-MODY (180).

Entretanto, a evolução da doença deve ser acompanhada de perto, pois com a deterioração da célula- β e controle glicêmico, deve-se pensar no tratamento com insulina (165). A identificação prévia desses pacientes é de extrema importância para prevenção de complicações vasculares, e nas mulheres para evitar hiperglicemia durante a gravidez (98).

1.8.4 Modificações no gene *HNF1B* associadas ao diabetes monogênico

Alterações no gene *HNF1 Homeobox B (HNF1B)* são causas menos frequentes de diabetes monogênico do tipo MODY, sendo sua frequência descrita variando de < 1% a 10% (45,91,98,185).

Na revisão conduzida por Chen e colaboradores (2010), incluindo 160 famílias com fenótipos renais, com MODY ou com os dois fenótipos presentes, 68 diferentes modificações foram descritas. O tipo de variante mais frequente encontrado nas famílias foi a deleção completa do gene (38,1%), seguido de modificações dos tipos de sentido trocado (30%), alteração do quadro de leitura (11,2%), sem sentido (10,7%), modificações em sítio de encadeamento (6,9%), indels de um único nucleotídeo e deleção sem mudança no quadro de leitura (1,9%, 0,6% e 0,6%, respectivamente). A maioria das modificações ocorreram nos primeiros quatro dos nove éxons do gene, sendo os éxons 2 e 4 e o sítio de encadeamento no íntron 2 considerados “pontos quentes”, onde a taxa de modificações são mais altas. (186). Deleções parciais ou totais do gene *HNF1B* representam cerca de 1/3 das causas de HNF1B-MODY (141,187,188). Além disso, inserções parciais raras já foram descritas (189), demonstrando a importância da dosagem gênica deste gene.

Recentemente, Santana e colaboradores (2019) descreveram três pacientes brasileiros com variantes de sentido trocado no gene *HNF1B*, sendo dois pacientes apresentando agenesia de corpo/calda do pâncreas e cistos renais, e um com redução difusa do pâncreas e enzimas hepáticas elevadas (168). Em 2016, Dotto e colaboradores descreveram um caso clínico de um paciente brasileiro *GCK* e *HNF1A* negativos, testando positivo para deleção completa do *HNF1B*. Mais recentemente (2019), eles descreveram outros dois brasileiros com alterações no gene *HNF1B*. Foram identificadas uma variante que muda o quadro de leitura e uma deleção completa do gene. Ambos pacientes apresentaram DM, cistos renais e hipomagnesemia; adicionalmente, o paciente com a deleção também mostrou agenesia pancreática (103,190).

Apesar de mutações associadas ao gene *HNF1B* terem o padrão de herança autossômico dominante, a região 12 do braço longo do cromossomo 17, que inclui o gene *HNF1B*, é suscetível a rearranjo genômico com recombinação não-homóloga na permuta

gênica. Essa recombinação errônea pode levar a deleções “de novo” podendo chegar até grandes deleções de 1,5 MB (191). A prevalência de deleções “de novo” é maior que 50% (192). Além de deleções completas do gene, mutações do tipo sentido trocado, também podem ocorrer espontaneamente (193).

1.8.4.1 O gene *HNF1B*

O gene *HNF1B* (OMIM *189907) possui 2.790 pb, se localiza em 17q12.5, possui nove éxons e codifica o HNF1B, membro da superfamília de fatores de transcrição. Ele é responsável pela regulação e expressão gênica através da sua forma como homodímero ou heterodímero com o fator HNF1A, os quais são similares estruturalmente. O HNF1B possui três domínios funcionais: o domínio de dimerização (aminoácidos 1-32), o domínio de ligação ao DNA, representado pelos subdomínios POU_s (aminoácidos 88-180) e POU_h (aminoácidos 229-319) e o domínio de transativação (aminoácidos 320-557) (194) (**Figura 12**).



Figura 12. Representação do gene *HNF1B* e dos domínios do fator de transcrição HNF1B. Na figura estão representados os 9 éxons do gene. As regiões não traduzidas 5' e 3' estão apresentadas em cinza. Transcrito NM_000458.4. **Fonte:** O autor.

O HNF1B é um importante fator de transcrição, tendo papel fundamental na regulação da transcrição de diferentes genes, como do *HNF4A* e do *SLC2A2* (*solute carrier family 2*), que codifica o transportador GLUT2 (195). Ele é expresso inicialmente durante a embriogênese, responsável pela especificação do endoderma visceral. Na vida adulta ele é expresso predominantemente nos rins, mas também é encontrado em diversos outros órgãos,

como no fígado, pâncreas, intestino, estômago, pulmões, trato urinário e genital, cérebro e glândulas paratireoides (196–198).

1.8.4.2 Características clínicas e controle glicêmico dos pacientes com modificações no gene *HNF1B*

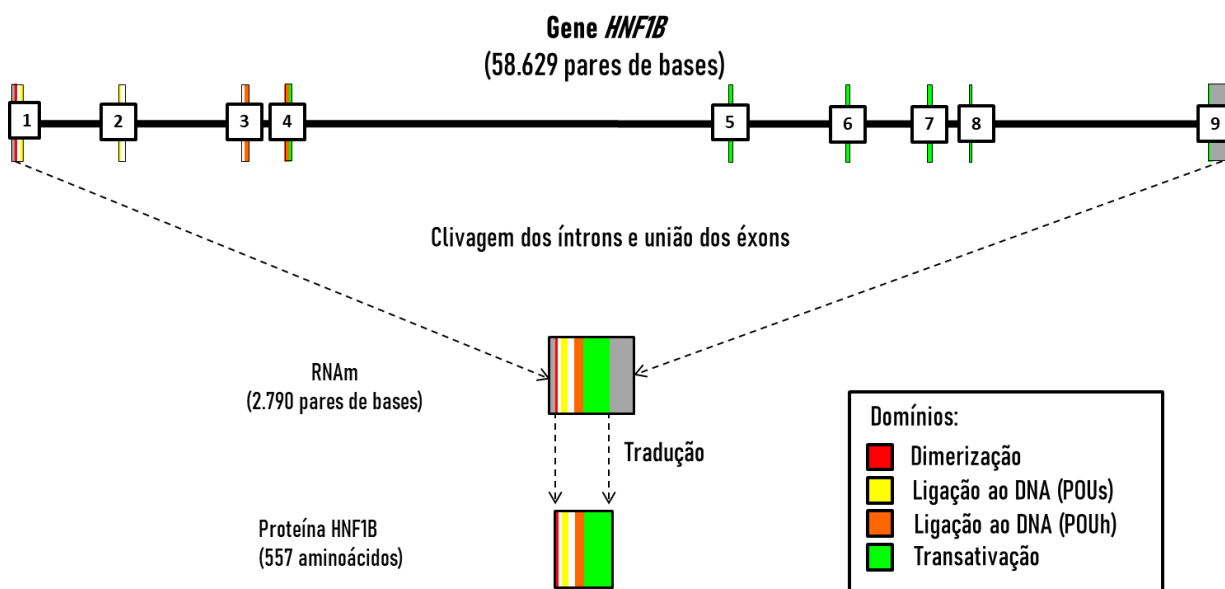
Alterações no gene *HNF1B* inicialmente foram descritas causar HNF1B-MODY (MODY5) (74), entretanto, posteriormente foi observado um fenótipo variável em pacientes com alterações nesse gene, sendo mais frequentemente observadas alterações renais do que diabetes, então foi denominada síndrome dos cistos renais e diabetes (RCAD, do inglês “renal cysts and diabetes syndrome”; OMIM #137920) (198). Atualmente sabe-se que além de afetar os rins e o pâncreas, alterações na expressão do *HNF1B* podem gerar diversas outras patologias clínicas e isso se deve ao fato deste fator de transcrição ser expresso e controlar a expressão de diversos genes em diferentes órgãos (**Figura 13**).

Chen e colaboradores (2010), através de um levantamento bibliográfico entre os anos de 1997 e 2008, descreveram 137 alterações no gene *HNF1B*, sendo a maior parte associada a fenótipos renais (61,3%), seguido de MODY com alterações renais (29,2%) e por último, pacientes que apresentaram somente MODY (9,5%) (186).

Alterações no *HNF1B* podem levar a complicações renais como displasia multicística, hipoplasia, agenesia unilateral, rim em formato de ferradura, hiperuricemia, gota, hipocalciúria e hipomagnesemia (186,199–201). Além disso, mutações neste gene podem ser letais, como em casos graves de anomalias congênitas dos rins e do trato urinário (CAKUT, do inglês “congenital abnormalities of the kidneys and urinary tract”) (202,203) (**Figura 13**).

O DM é um dos quadros clínicos extra-pancreáticos observados em pacientes com alterações no *HNF1B*, visto que seu correto funcionamento é essencial para maturação das células- β . A idade de manifestação do diabetes nestes pacientes varia entre período neonatal até a vida adulta, e anomalias na estrutura renal geralmente precedem a manifestação do DM (77,186,193,204). Pacientes com mutações no *HNF1B* tem a diminuição da sensibilidade da insulina à produção de glicose endógena, entretanto a sensibilidade periférica é normal, resultando em hiperinsulinemia associada à dislipidemia, com aumento dos níveis de triglicerídeos e diminuição dos níveis de HDL (205,206). A maioria dos pacientes com diabetes associadas a alterações no *HNF1B* não respondem bem ao tratamento com sulfonilureia, sendo tratados com insulina. A idade média de iniciação do tratamento com insulina é próxima aos 25 anos de idade; geralmente o intervalo entre o diagnóstico de DM até o início do tratamento é de três anos (186,205). Além da disfunção endócrina, mais

raramente alguns pacientes podem apresentar atrofia do órgão e disfunção exócrina com diminuição da concentração da elastase fecal (186). Além disso, a diminuição da secreção de insulina no útero pode levar a atraso no crescimento fetal e diminuição do peso ao nascimento (77).

Entre os fenótipos clínicos extra-pancreáticos observados em pacientes com mutações no *HNF1B* estão descritas anormalidades do trato genital, como por exemplo, a formação de útero didelfo (dois úteros) podendo ocasionar redução na fertilidade (**Figura 13**). Além disso, a malformação no trato genital masculino também já foi reportada, como um caso de hipospádia descrito, que ocorre quando o meato uretral abre na superfície ventral do pênis (186,201,203).

Loirat e colaboradores (2010) descreveram três crianças com deleções na região 17q12 apresentando autismo e problemas renais, incluindo cistos (207). Ferrè e colaboradores (2013) descreveram pacientes com alterações no *HNF1B* com hiperparatireoidismo e com o paratormônio elevado. O *HNF1B* inibe a transcrição do gene *Parathyroid Hormone (PTH)*, que codifica o hormônio paratormônio. Em casos em que o *HNF1B* não consegue desempenhar sua função corretamente, parece haver super expressão do gene *PTH* levando ao quadro de hiperparatireoidismo (208) (**Figura 13**).

Além da ampla diversidade fenotípica que pode ser observada em indivíduos com alterações no gene *HNF1B*, membros de uma família com mesma alteração genética podem expressar características clínicas variáveis (194).



Figura 13. Características frequentemente observadas em pacientes com doenças associadas a modificações no gene *HNF1B* ou alterações em genes alvos regulados pelo fator de transcrição *HNF1B* (em vermelho). **Fonte:** O autor, Adaptado de (194,196).

1.9 Formas raras do diabetes monogênico

1.9.1 Modificações no gene *INS* associadas ao diabetes monogênico

Modificações no gene *Insulin (INS)* já foram associadas à hiperinsulinemia, hiperproinsulinemia, DM do tipo 1 com autoanticorpos positivos (tipo 1a) e negativos (tipo 1b), diabetes neonatal e INS-MODY (MODY10; OMIM #613370) (48). Modificações no gene *INS* foram descritas associadas à INS-MODY, entretanto são causas raras desta doença e o tratamento varia entre dieta, medicamentos orais e insulina (83,209,210). Santana e colaboradores (2019), em um estudo conduzido em pacientes brasileiros com fenótipo clínico de MODY, descreveram uma variante no gene *INS* como possivelmente patogênica, sendo uma variante nova de alteração do quadro de leitura p.Ala23Glnfs*3 (168).

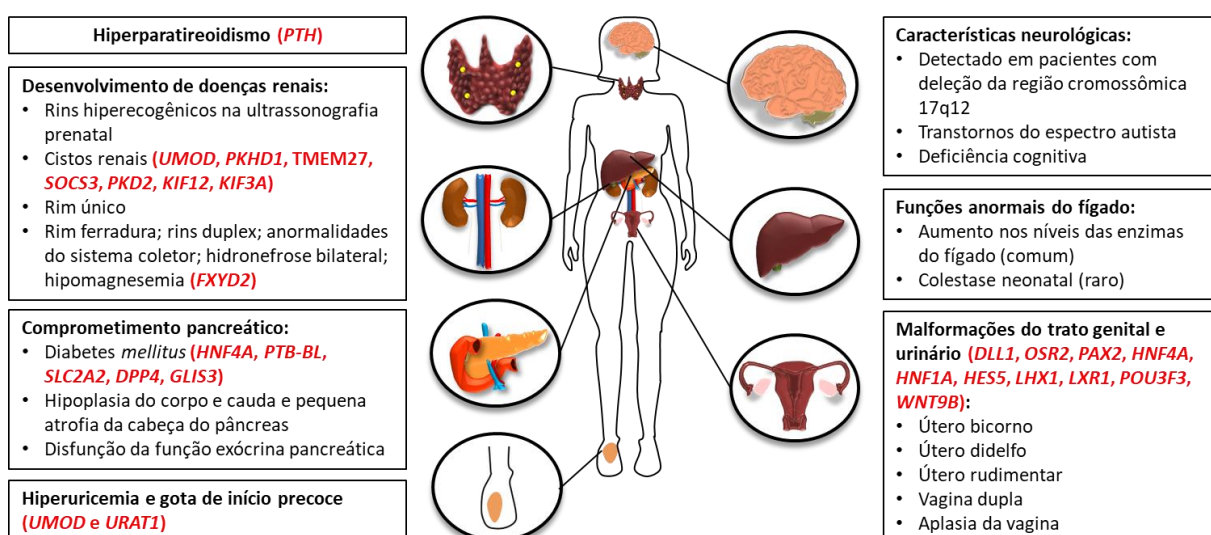
O gene *INS (INS; OMIM *176730)* é mapeado em 11p15.5 e possui três éxons, sendo o éxon 1 constituído apenas pela região não traduzida do DNA 5' UTR (UTR, do inglês “untranslated region”), o éxon 2 codifica o peptídeo sinal, a cadeia- β e parte do peptídeo de conexão (peptídeo-C) e o éxon 3 codifica a continuação do peptídeo-C e a cadeia- α (**Figura 14**).



Figura 14. Diagrama da molécula humana de pré-pró-insulina. **Fonte:** O autor, adaptado de (48).

A síntese do hormônio de insulina é praticamente específica das células β -pancreáticas. O primeiro produto da tradução do gene *INS* é um polipeptídeo de 110 aminoácidos, sendo os 24 primeiros aminoácidos o peptídeo sinal. O peptídeo sinal é ligado pela partícula de sinal de reconhecimento (SRP, do inglês “signal-recognition particle”), e através da interação do receptor do SRP na membrana do retículo endoplasmático (RE) a pré-pró-insulina consegue entrar no lúmen do RE, e ocorre então a clivagem do peptídeo sinal gerando a pró-insulina. A pró-insulina muda de conformação através de três ligações dissulfídicas, sendo transferida para o complexo de Golgi, e posteriormente armazenada em grânulos secretórios que seguem para a exocitose. A clivagem da pró-insulina em insulina e peptídeo-C ocorre dentro desses grânulos (211,212).

1.9.2 Modificações no gene *KLF11* associadas ao diabetes monogênico

Modificações no gene *Kruppel-Like Factor 11 (KLF11)* são causas raras de KLF11-MODY (MODY7; OMIM #610508). Neve e colaboradores (2015), descreveram a variante p.Ala347Ser segregando em três gerações de uma família com DM/ intolerância à glicose, e a variante p.Tre220Met em duas famílias, mas não foi possível observar a segregação com a doença nas diferentes gerações destas famílias (80). Recentemente, Ushijima e colaboradores

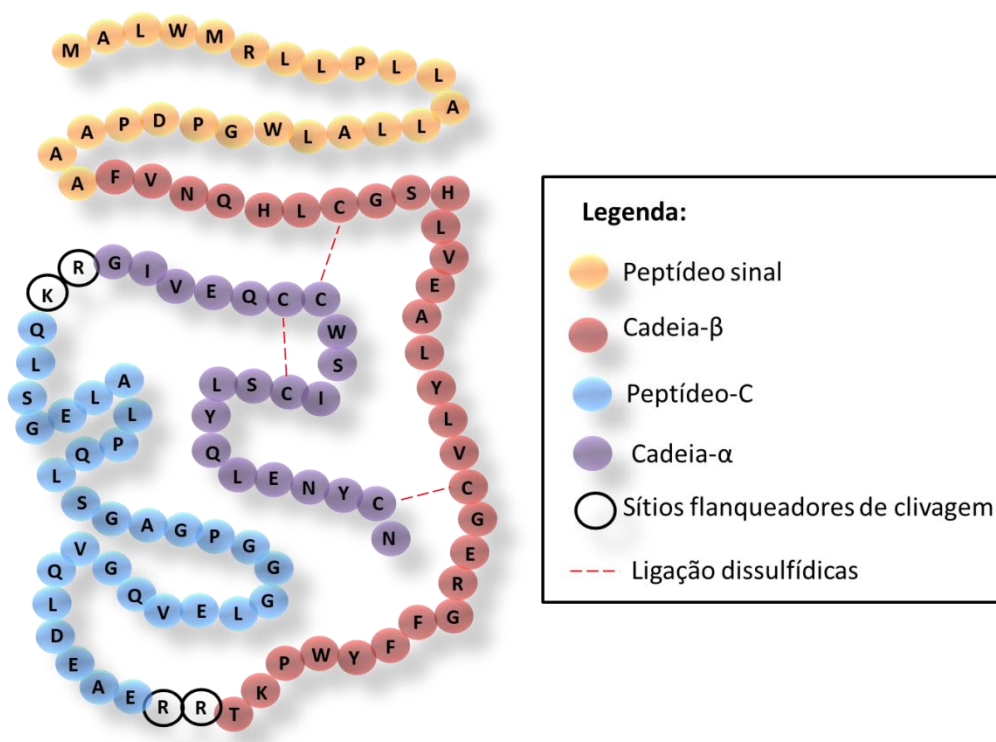
(2019) descreveram a variante p.His418Gln em dois irmãos com diabetes tipo 1B, diagnosticados com 1 ano de idade, e na mãe diagnosticada aos 4 anos. Entretanto, essa variante também foi observada na avó materna do probando, não diabética, sugerindo penetrância incompleta da variante (213).

O gene *KLF11* (OMIM *603301) é membro da família de fatores de transcrição Sp1/Krüppel-like zinc finger, se localiza na região cromossômica 2p25.1, possui quatro éxons e codifica o fator de transcrição KLF11. Este fator de transcrição possui uma região C-terminal altamente conservada, um domínio de ligação ao DNA, contendo três motivos de zinco, DZ1 (aminoácidos 394-418), DZ2 (aminoácidos 424-448) e DZ3 (aminoácidos 454-476) e uma região N-terminal que possui três domínios de repressão, denominados R1, R2 e R3 (214,215) (**Figura 15**).



Figura 15. Representação do gene *KLF11* e dos domínios do fator de transcrição KLF11. Na figura estão representados os quatro éxons do gene. As regiões não traduzidas 5' e 3' estão apresentadas em cinza. Transcrito NM_003597.5. **Fonte:** O autor.

Apesar do KLF11 inicialmente ter sido descrito como um fator de transcrição apenas repressor, atualmente sabe-se que ele também tem função ativadora (80). O KLF11 é altamente expresso no pâncreas e está envolvido no crescimento e regulação das células endócrinas e exócrinas (216). Através dos motivos dedos de zinco, ele se liga a sequências de repetições ricas em GC, como é o caso da região promotora do gene da insulina. Em altas concentrações de glicose, o KLF11, juntamente com outros ativadores, formam uma

maquinaria se ligando na região promotora do gene *INS*, ativando-o, e conseqüentemente aumentando a produção de insulina, sendo um importante fator para a homeostase da glicose (80). Além disso, Fernandez-Zapico e colaboradores (2009) descreveram o KLF11, juntamente com o cofator p300, como um dos fatores de transcrição que atuam na regulação da expressão do gene *PDX1* (217).

1.9.3 Modificações no gene *KCNJ11* associadas ao diabetes monogênico

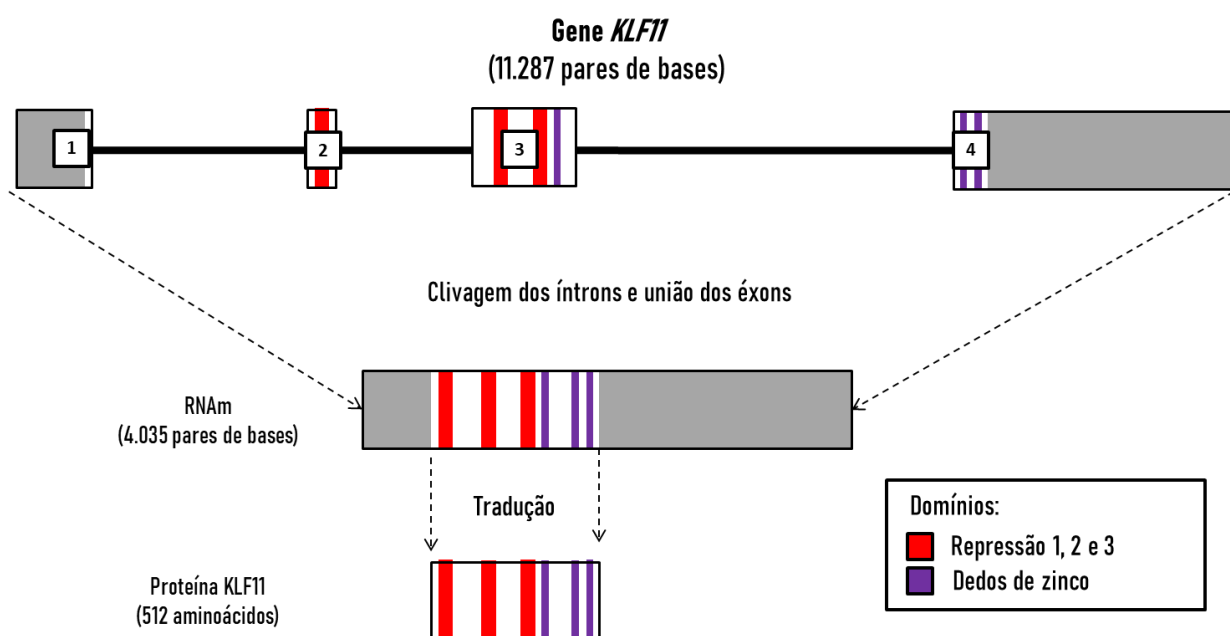
Modificações no gene *Potassium Channel, Inwardly Rectifying, Subfamily J, Member 11 (KCNJ11)* podem levar a um espectro de manifestações clínicas, como diabetes de manifestação precoce, diabetes gestacional e *KCNJ11-MODY* (*MODY13*; OMIM #616329) (87,218), que são bem raros, e mais frequentemente estão associadas ao DMNP e DMNT (52,219–221). Modificações nos canais de potássio SUR1/Kir6.2 (K^+_{ATP}) são as principais causas de DMNP (OMIM #606176) (222). Mutações ativadoras em ambos os genes (*KCNJ11* e *ABCC8*) reduzem a habilidade de fechamento destes canais e conseqüentemente reduzem a liberação da insulina, resultando no quadro de diabetes (52,167,219).

O gene *KCNJ11* (OMIM *600937) localiza-se em 11p15.1, possui um único éxon de 2.801 pb e codifica a subunidade Kir6.2, que faz parte do canal de potássio (K^+_{ATP}) (**Figura 16**). Estes canais são constituídos por um complexo octâmero, contendo um tetrâmero central de Kir6.2, envolto por quatro subunidades de SUR1, que é codificada pelo gene *ABCC8* (**Figura 10**).



Figura 16. Representação do gene *KCNJ11* demonstrando seu único éxon, que é responsável por codificar a subunidade Kir6.2 dos canais de potássio (K⁺ATP). As regiões não traduzidas 5' e 3' estão apresentadas em cinza. Na parte inferior esquerda da figura está apresentada a representação gráfica da subunidade Kir6.2 inserida na membrana plasmática. Transcrito NM_000525.4. **Fonte:** O autor.

Os canais de potássio SUR1/Kir6.2 não são exclusivos das células β -pancreáticas, eles também são expressos em outros tecidos como no tecido muscular e no nervoso. Devido a isto, mais raramente, uma ampla diversidade de sintomas podem estar presentes em pacientes com mutações que alterem estes canais: atraso no desenvolvimento motor e mental, déficit de atenção, autismo, hiperatividade, deficiência intelectual, ansiedade, convulsões e perda da coordenação óculo-manual (223–225).

1.9.4 Modificações no gene *NEUROD1* associadas ao diabetes monogênico

Após 20 anos desde o primeiro caso de diabetes monogênica ocasionado devido a uma mutação no gene *NEUROD1* (79), apenas poucas famílias foram relatadas com NEUROD1-MODY (MODY6; OMIM #606394) se restringindo à famílias europeias (226–229) e asiáticas

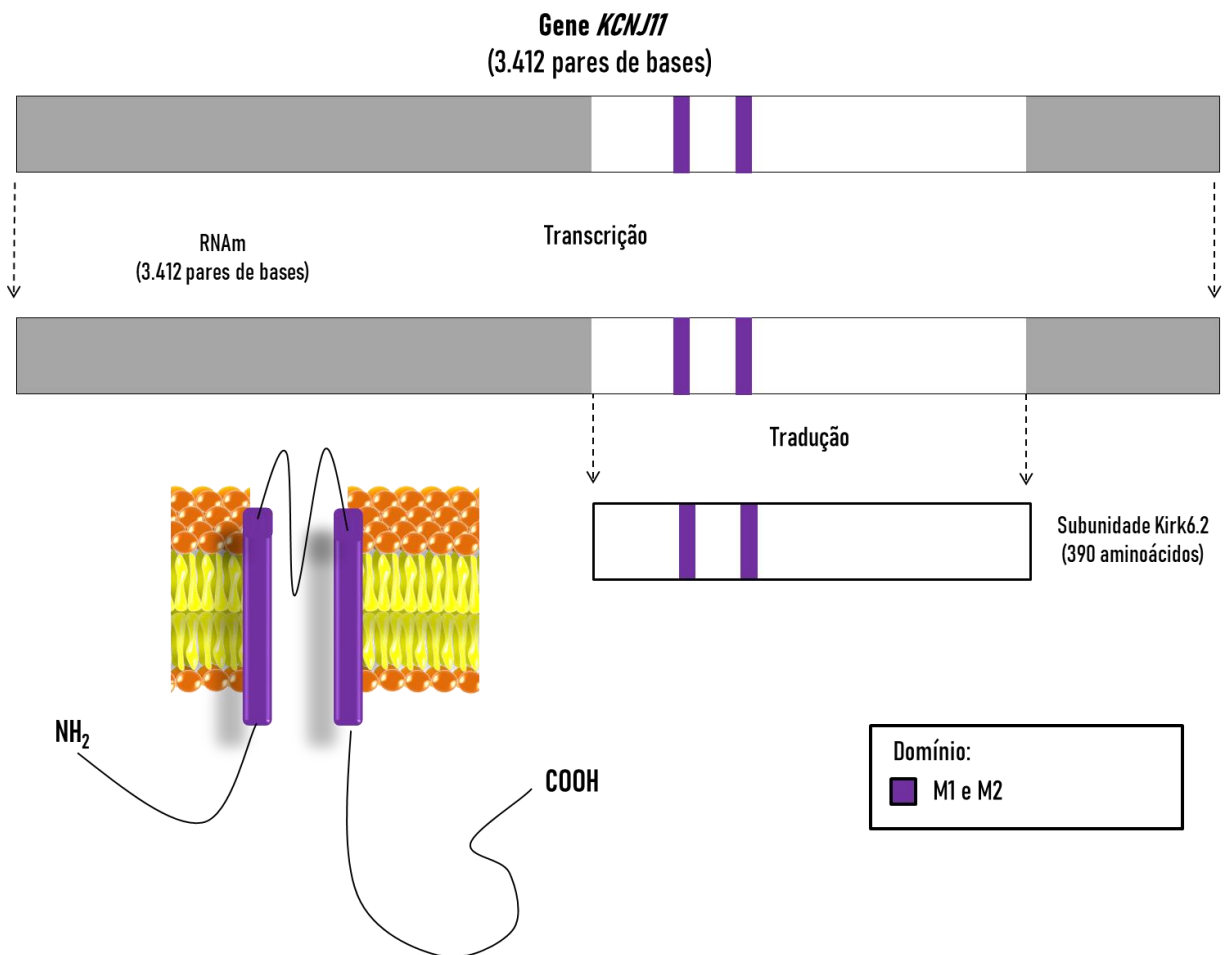
(230–234): O gene *Neuronal differentiation 1* (*NEUROD1*; OMIM *601724) é mapeado em 2q31.3 e possui dois éxons, sendo apenas o segundo éxon codificante. O éxon 2 codifica os domínios “basic adjacent, helix 1, loop and helix 2” (bHLH) (aminoácidos 100-155) e o domínio de transativação (aminoácidos 189-355). (**Figura 17**).



Figura 17. Representação do gene *NEUROD1* e dos domínios do fator de transcrição NEUROD1. Na figura estão representados os dois éxons do gene. A região exônica não traduzidas está representada em cinza claro e as regiões não traduzidas 5’ e 3’ estão apresentadas em cinza escuro. bHLH: “basic adjacent, helix 1, loop and helix 2” Transcrito NM_002500.5. **Fonte:** O autor.

O *NEUROD1* codifica um fator de transcrição (NEUROD1) que em altas concentrações citoplasmáticas de glicose se heterodimeriza com o fator de transcrição E47, e estes se ligam ao sítio de ligação E-box da região promotora do gene *INS* e com o auxílio de coativadores, como a p300, ativam a transcrição do gene da insulina (235) (**Figura 18**).

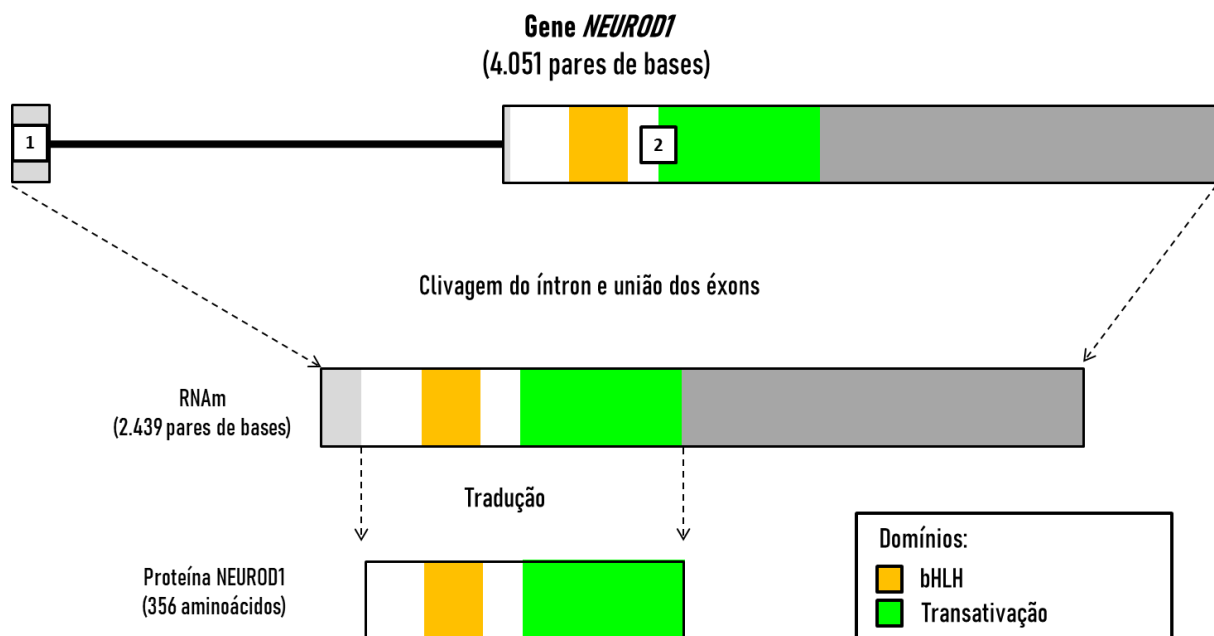

Figura 18. Ativação do gene da insulina (*INS*) via NEUROD1. P: fosforilação; G: O-glicosilação com N-acetil-glucosamina. **Fonte:** O autor, Adaptado de (236).

1.9.5 Modificações no gene *PAX4* associadas ao diabetes monogênico

Até recentemente, menos de 10 casos de *PAX4*-MODY (MODY9; OMIM #612225) haviam sido reportados na literatura, sendo identificados apenas em populações asiáticas (82,231,232,237,238). O gene *Paired Box Gene 4* (*PAX4*; OMIM *167413) localiza-se em 7q32.1 e possui 12 éxons, sendo dez traduzidos. O gene *PAX4* teve seu transcrito recentemente atualizado (ENST00000639438.3), de forma que as modificações já descritas no transcrito anterior (ENST00000341640.6) tiveram suas nomenclaturas atualizadas. Esse gene codifica o fator de transcrição *PAX4*, que possui os domínios “paired”, responsável por se ligar ao DNA, o homeodomínio, um domínio completo de interação ao DNA, e o domínio com função repressora (**Figura 19**).

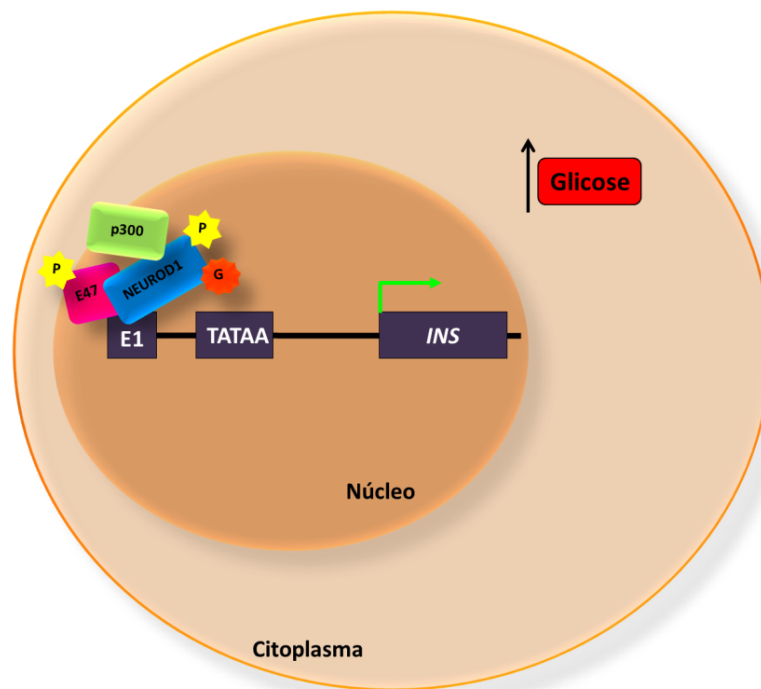

Figura 19. Representação do gene *PAX4* e dos domínios do fator de transcrição *PAX4*. Na figura estão representados os 12 éxons do gene. As regiões exônicas não traduzidas estão representadas em cinza claro e a região não traduzida 3' está apresentada em cinza escuro. Transcrito NM_001366110.1. **Fonte:** O autor.

O *PAX4* é expresso em todas as células endócrinas progenitoras durante o desenvolvimento do pâncreas (239,240). Posteriormente há uma regulação cruzada de repressão entre os fatores de transcrição *PAX4* e *ARX* (“aristaless-related homeobox x-linked”) para promover a diferenciação das células endócrinas (241) (**Figura 20**).

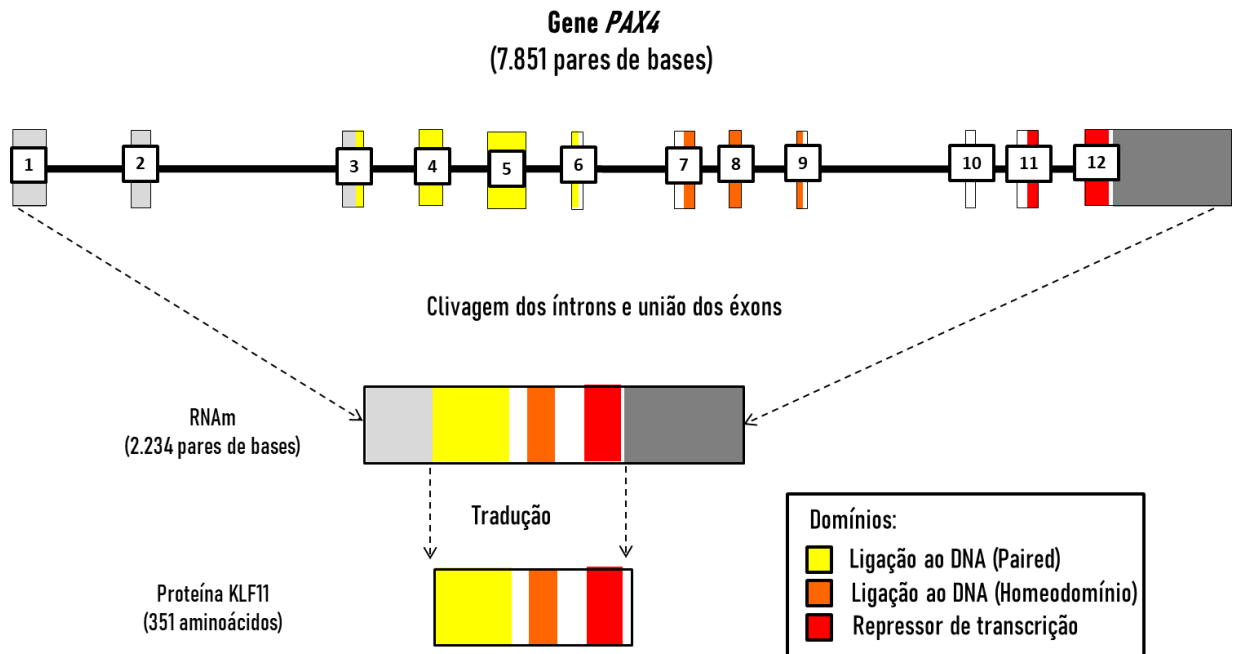

Figura 20. Representação simplificada da regulação cruzada entre os fatores de transcrição PAX4 e ARX para promover a diferenciação das células endócrinas. A seta em vermelho representa inibição. **Fonte:** O autor, adaptado de (241).

1.9.6 Modificações no gene *PDX1* associadas ao diabetes monogênico

Desde sua descrição (76), modificações no gene *PDX1* têm sido associadas a múltiplas formas de DM (242–244) entretanto, formas monogênica da doença, como diabetes neonatal e PDX1-MODY (MODY4; OMIM #606392), foram relatadas apenas em poucos casos em todo mundo (231,245–250). O gene *Pancreatic and Duodenal Homeobox 1* (*PDX1*; OMIM *600733) localiza-se em 13q12.2, possui dois éxons e codifica o fator de transcrição PDX-1, que possui o domínio de transativação (aminoácidos 1-79) e o domínio de ligação ao DNA (aminoácidos 146-206). Este fator de transcrição é requerido para o desenvolvimento e funcionamento normal das células-β (76) (**Figura 21**). O PDX-1 está envolvido na regulação da expressão de genes nas células-β, como os genes *GLUT2* (251), *IAPP* (*islet amyloid polypeptide*) (252), *GCK* (253), *INS* (*insulin*) (254) e sua própria expressão (255).

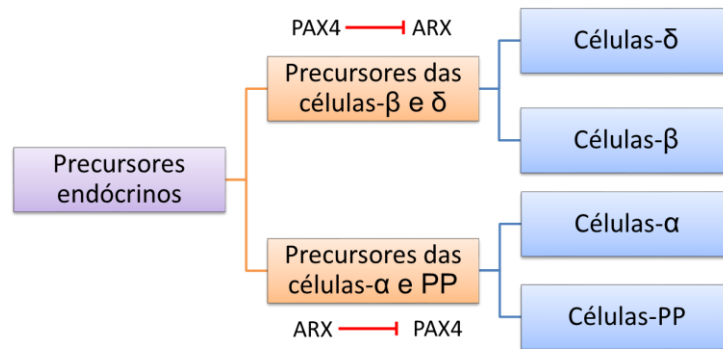

Figura 21. Representação do gene *PDX1* e dos domínios do fator de transcrição PDX-1. Na figura estão representados os 2 éxons do gene. As regiões 5' e 3' não traduzidas estão representadas em cinza. Transcrito NM_000209.4. **Fonte:** O autor.

1.10 Impacto do diagnóstico molecular no prognóstico do diabetes monogênico

O diagnóstico clínico com precisão dos pacientes com diabetes monogênico tem influência direta no prognóstico da doença, no tratamento direcionado para cada caso e no aconselhamento familiar. Atualmente ainda há poucos estudos de rastreamento molecular em coorte brasileira, não revelando a real contribuição genética das formas monogênicas para o desenvolvimento de diabetes na nossa população, implicando em seu diagnóstico incorreto e, conseqüentemente, no manejo terapêutico muitas das vezes inadequado. Desta forma, a aplicação de ferramentas moleculares se faz necessária em casos em que há alta recorrência familiar de diabetes de modo a contribuir na descoberta da alteração genética que está ocorrendo nestas famílias.

2. Objetivos

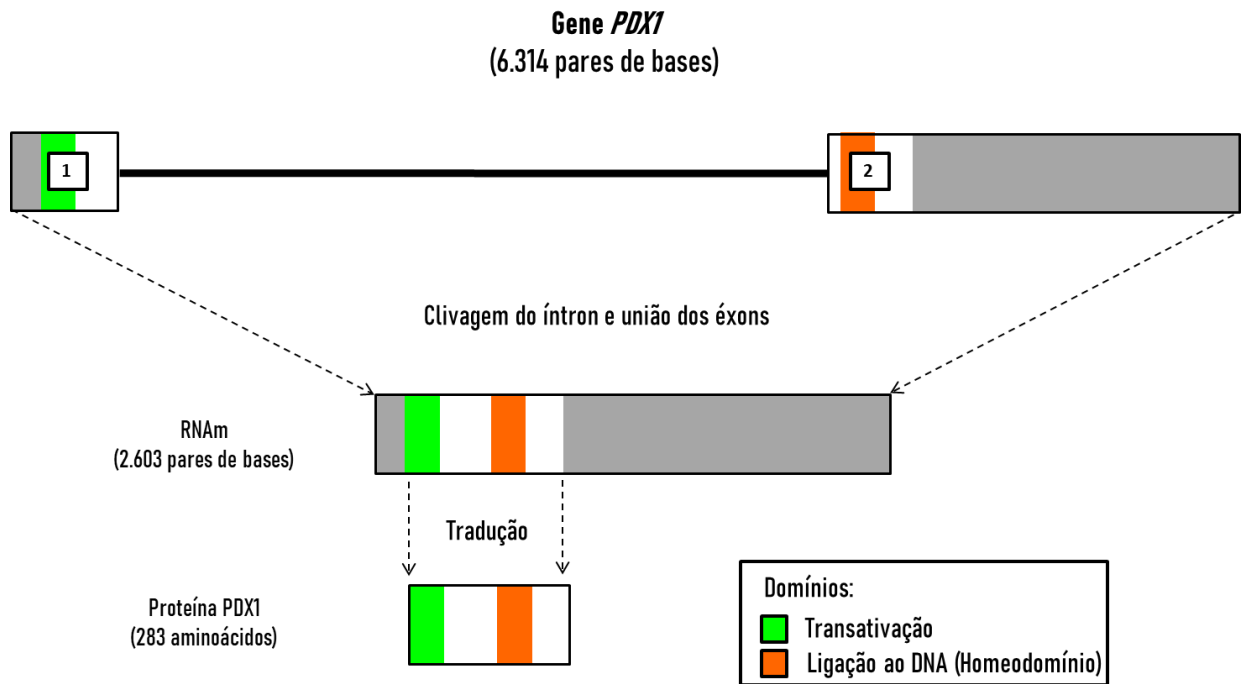
2.1 Objetivo geral

O presente estudo teve por objetivo o rastreamento molecular de onze genes para identificação de modificações causadoras do diabetes *mellitus* dos tipos monogênicos em uma amostra de pacientes acompanhados em centros hospitalares da cidade do Rio de Janeiro e a investigação da influência desses genes nos casos de diabetes na nossa população. Desta forma, esperamos contribuir com o entendimento das formas monogênicas do diabetes através da observação de novas modificações, da correlação das modificações identificadas com o fenótipo clínico do paciente e do estabelecimento de quais genes são mais importantes na nossa população.

2.2 Objetivos específicos

- Rastrear as regiões codificantes dos genes *GCK* e *HNF1A*, assim como suas regiões intrônicas flanqueadoras em uma amostra de 68 pacientes brasileiros, não aparentados e de ambos os sexos, com características clínicas de diabetes monogênico.
- Realizar o rastreamento das regiões codificantes dos genes *HNF4A*, *HNF1B*, *PDX1*, *NEUROD1*, *KLF11*, *PAX4*, *INS*, *KCNJ11* e *MT-TL1* bem como de suas regiões intrônicas flanqueadoras nos pacientes que não apresentarem variantes nos genes *GCK* ou *HNF1A*.
- Descrever novas modificações nos genes estudados;
- Analisar a relação das modificações encontradas com o quadro clínico de cada indivíduo afetado.
- Rastrear a presença das variantes encontradas nos familiares dos indivíduos afetados para análise de segregação.
- Descrever a frequência de variantes encontradas nos diferentes genes estudados na causa de diabetes raros em pacientes brasileiros.
- Rastrear as variantes na literatura identificadas em nossa amostra em um grupo de amostra de controles saudáveis.
- Analisar o impacto molecular das variantes identificadas na estrutura das proteínas através do uso de ferramentas de bioinformática.
- Emitir relatórios de pesquisa para os probandos com variantes provavelmente patogênicas e familiares testados.

3. Resultados

Capítulo I

“MODY probability calculator for *GCK* and *HNF1A* screening in a multiethnic background population”

O diagnóstico clínico de formas raras de diabetes é confirmado apenas através de testes moleculares que ainda são custosos e limitados a laboratórios de pesquisa e laboratórios privados no Brasil. O correto diagnóstico destes pacientes se faz necessário visto o impacto direto no tratamento farmacológico diferenciado. Assim, o desenvolvimento de estratégias clínicas de seleção que aumentem a eficácia do poder de detecção de possíveis casos gera melhor custo-benefício e direcionam de forma mais precisa o teste genético. Neste capítulo descrevemos modificações identificadas em uma amostra inicial de 34 pacientes encaminhados para o estudo dos genes *GCK* ou *HNF1A*. A partir dos resultados obtidos da análise molecular, foi utilizada a calculadora de probabilidade de diagnóstico de MODY (do inglês, “MODY probability calculator” - MPC), onde pudemos demonstrar sua eficiência na detecção de pacientes com a forma *GCK*-MODY, além de aumentar a sensibilidade na captação de pacientes *HNF1A*-MODY, gerando um melhor custo-benefício.

Esse trabalho foi desenvolvido como tema de Mestrado da Msc. Roberta Magalhães Tarantino em colaboração com o nosso grupo.

Os Termos de Consentimento Livre e Esclarecido do Hospital Universitário Clementino Fraga Filho (UFRJ), do Instituto Estadual de Diabetes e Endocrinologia Luiz Capriglione (IEDE) e o Questionário aplicado aos pacientes estão apresentados nos **Anexos A, B e C**, respectivamente.

Publicado na revista: *Archives of Endocrinology and Metabolism* 2020; 64(1):17-23.

MODY probability calculator for *GCK* and *HNF1A* screening in a multiethnic background population

Roberta Magalhães Tarantino¹
<https://orcid.org/0000-0001-7759-1664>

Gabriella de Medeiros Abreu²
<https://orcid.org/0000-0002-0434-3815>

Ana Carolina Proença de Fonseca²
<https://orcid.org/0000-0001-6123-0481>

Rosane Kupfer³
<https://orcid.org/0000-0002-4073-0038>

Maria de Fátima Carvalho Pereira⁴
<https://orcid.org/0000-0003-3932-6481>

Mario Campos Júnior²
<https://orcid.org/0000-0002-7121-0748>

Lenita Zajdenverg¹
<https://orcid.org/0000-0002-1579-3299>

Melanie Rodacki¹
<https://orcid.org/0000-0002-9007-1325>

¹ Seção de Diabetes e Nutrologia, Departamento de Medicina Interna, Universidade Federal do Rio de Janeiro (UFRJ), Rio de Janeiro, RJ, Brasil

² Laboratório de Genética Humana, Instituto Oswaldo Cruz, Fundação Oswaldo Cruz, Rio de Janeiro, RJ, Brasil

³ Seção de Diabetes, Instituto Estadual de Diabetes e Endocrinologia do Rio de Janeiro, Rio de Janeiro, RJ, Brasil

⁴ Departamento de Patologia Clínica da Universidade Federal do Rio de Janeiro, Rio de Janeiro, RJ, Brasil

ABSTRACT

Objective: We aimed to identify the frequency of monogenic diabetes, which is poorly studied in multiethnic populations, due to *GCK* or *HNF1A* mutations in patients with suggestive clinical characteristics from the Brazilian population, as well as investigate if the MODY probability calculator (MPC) could help patients with their selection. **Subjects and methods:** Inclusion criteria were patients with DM diagnosed before 35 years; body mass index < 30 kg/m²; negative autoantibodies; and family history of DM in two or more generations. We sequenced *HNF1A* in 27 patients and *GCK* in seven subjects with asymptomatic mild fasting hyperglycemia. In addition, we calculated MODY probability with MPC. **Results:** We identified 11 mutations in 34 patients (32.3%). We found three novel mutations. In the *GCK* group, six cases had mutations (85.7%), and their MODY probability on MPC was higher than 50%. In the *HNF1A* group, five of 27 individuals had mutations (18.5%). The MPC was higher than 75% in 11 subjects (including all five cases with *HNF1A* mutations). **Conclusion:** Approximately one third of the studied patients have *GCK* or *HNF1A* mutations. Inclusion criteria included efficiency in detecting patients with *GCK* mutations but not for *HNF1A* mutations (< 20%). MPC was helpful in narrowing the number of candidates for *HNF1A* screening.

Keywords

GCK; *HNF1A*; MODY; monogenic diabetes

Correspondence to:

Roberta M. Tarantino
 Rua Rodolpho Paulo Rocco, 255,
 Ilha do Fundão
 21941-590 – Rio de Janeiro, RJ, Brasil
 drarobertatarantino@gmail.com

Received on Feb/25/2019
 Accepted on Jun/19/2019

DOI: 10.20945/2359-399700000173

INTRODUCTION

The frequency of monogenic diabetes mellitus (DM) has been underestimated in various populations (1). Most cases are caused by mutations in *GCK* [glucokinase gene] (GCK MODY [maturity onset diabetes of the young]) or *HNF1A* [hepatocyte nuclear factor 1-alpha gene] (*HNF1A* MODY) (2). Their molecular diagnosis is expensive but promotes the improvement of genetic counseling and treatment (3). Strategies to select the ideal subjects to screen for monogenic DM (MDM) in different populations are necessary to establish cost-effective diagnostic algorithms.

Different authors have developed clinical criteria for MODY screening based on age, family history and clinical characteristics (4,5). Although their use appears to be cost-effective (6), there is a concern that the screening based on clinical criteria would either miss part of the affected patients or still result in an excessive number of genetic tests (7). Therefore, authors have pursued optimal strategies for selecting patients. Shields and cols. developed a clinical prediction model that generates a probability of MODY (8) and shows good discrimination between MDM and type 1 (T1DM) or type 2 DM (T2DM) in European patients diagnosed under 35 years. The performance of this calculator in non-Caucasians is unknown.

The Brazilian population is very diverse and comprises individuals from multiple ethnic backgrounds, especially Caucasoid and Afro-descendants. There are scarce data about the prevalence of MDM and its optimal screening strategy in this setting. Our aim in this study was to estimate the frequency of MDM due to *GCK* or *HNFLA* mutations in patients with suggestive clinical characteristics and to investigate if the MODY probability calculator (MPC) could improve patient detection in this population (8,9).

SUBJECTS AND METHODS

In this cross-sectional observational study, we selected patients clinically defined with monogenic diabetes from two specialized centers in Rio de Janeiro, between March 2012 and June 2015. MODY screening is not part of the routine laboratory panel of either center. We analyzed thirty-four unrelated probands from Brazilian families for mutations in *GCK* and *HNFLA*.

The inclusion criteria were age of DM diagnosis \leq 35 years, body mass index (BMI) \leq 30 kg/m² or 95th percentile at onset, negative anti-glutamic decarboxylase antibody (anti-GAD) and anti-islet antigen 2 antibody (anti-IA2) antibodies and family history of diabetes in at least two generations, excluding the generation of the index case, and/or two or more first-degree relatives at the same side of the family. We excluded patients with T1DM; past diabetic ketoacidosis; clinical signs of insulin resistance (acanthosis nigricans, increased abdominal circumference and obesity); and secondary causes of diabetes.

The Ethics and Research Committee of the Clementino Fraga Filho University Hospital and State Institute of Diabetes and Endocrinology of Rio de Janeiro approved this study protocol. We informed all participants about the aim of this study and provided verbal and written consent.

We calculated the positive predictive value (PPV) for MODY based on the MPC for each patient (8) and divided the patients into two groups. The *GCK* group included patients with fasting hyperglycemia (100-154 mg/dL); increased glycaemia after 75 g anhydrous dextrose $<$ 54 mg/dL and HbA1c $<$ 7.5% (58 mmol/mol); and evolutionarily stable disease (even without antidiabetic drugs), most often asymptomatic and with hyperglycemia since birth (10). The *HNFLA* group included all other cases that met the inclusion criteria and that did not have the profile for the *GCK* group.

We isolated genomic DNA from peripheral blood leukocytes using QIAamp DNA Blood Mini Kit (Qiagen, Hilden, Germany). Also, we purified PCR products using Clean Sweep PCR Purification Reagent (Applied Biosystems, Vilnius, Lithuania). Then, we performed screening of the entire coding sequence of *GCK* and *HNFLA* genes through bidirectional Sanger sequencing using the Big Dye Terminator Kit v3.1 (Applied Biosystems, Austin, TX, USA), conducted on an ABI 3130 Automatic Genetic Analyzer (Applied Biosystems). Primers sequences are available upon request. We confirmed all mutations by bidirectional sequencing of a second PCR reaction. Then, we estimated the serum levels of anti-GAD and anti-IA2 antibodies by means of an enzyme-linked immunosorbent assay method (ELISA) using a EUROIMMUN kit.

We checked the variants identified against public Databases PubMed, Clinvar, dbSNP (<https://www.ncbi.nlm.nih.gov/>), Human Genome Mutation Database (HGMD®) (<http://www.hgmd.cf.ac.uk/ac/>), ExAC Browser (<http://exac.broadinstitute.org/>), GnomAD (<http://gnomad.broadinstitute.org/>) and 1000 Genomes project database (<http://www.internationalgenome.org/>) to investigate their previous identification in the literature. We performed functional analyses using Mutation Taster (<http://www.mutationtaster.org/>) (11-13).

We evaluated the differences between patients with mutations and others with Student's t-test and chi-square tests. In addition, we performed statistical analysis using SPSS software (version 22.0).

RESULTS

Characteristics of the study group

We included 34 individuals (61.7% females) with a mean age of DM diagnosis and a duration of 19.8 ± 8.8 and 14.6 ± 9.9 years, respectively, as well as a mean BMI of 22.8 ± 3.2 kg/m². 55.8% used insulin, and 41.2% used oral antidiabetic drugs (OAD). Their previous DM classifications included the following: non-classified in 38.2%, T1DM in 35.3%, T2DM in 23.5% and gestational diabetes (GDM) in 3%. Patients in the *GCK* (n = 7) and *HNFLA* (n = 27) groups had similar age at onset (16.1 ± 7.8 vs 20.8 ± 9.0 years; p = 0.286), diabetes duration ($9.88.8$ vs 15.4 ± 10.1 years; p = 0.82) or BMI (20.6 ± 4.0 vs 23.3 ± 2.8 ; p = 0.143).

None of the patients in the *GCK* group used insulin, and one used OAD. Most patients (70.3%) in

the *HNEA* group used insulin (mean dose: 0.9 ± 0.4 UI/kg/day), and 48.1% used OAD.

Genetic tests

We found MODY mutations (*GCK* or *HNFLA*) in 11 patients (32.3%). Fifty per cent of patients with non-classified DM had mutations in *GCK* or *HNFLA*. We found mutations in 16.6% of those previously classified as T1DM and in none classified as T2DM. The only patient classified as GDM had a *GCK* mutation.

In the *GCK*-suspicious group, six cases had mutations (85.7%): Five were missense mutations: p.Tyr61Asp (c.181T>G; novel); p.Arg191Trp (c.571C>T); p.Thr228Met (c.683C>T); p.Ala384Val (c.1151C>T); p.Gly227Asp (c.680G>A); and one in-frame deletion p.Phe150del (c.449_451delTCT). We tested the patient in this group without the *GCK* mutation for *HNFLA*, and we found no mutations.

In the MODY-*HNFLA*-suspicious group, we found five mutations (5/27-18.5%); three missense

substitutions: p.Gly31Asp (c.92G>A), p.Val133Glu (c.398T>A; novel) and p.Trp165Arg (c.493T>C); one nonsense mutation: p.Arg171Ter (c.511C>T); and one frameshift insertion: p.Thr433Hisfs*116 (c.1296_1297insC; (novel). Patients with *HNFLA* mutations used insulin less frequently than others. Those who used insulin reported a lower insulin dose/kg (Table 1). Other characteristics of those with or without *HNFLA* mutations are shown in Table 1.

Among the 11 mutations, eight had already been described, and three were novel mutations. The mutation p.Tyr61Asp (c.181T>G), found in exon 2 of the *GCK* gene of one patient, is a missense mutation classified as pathogenic. The other two novel mutations occurred in the *HNFLA* gene (exons 2 and 6). We considered the missense mutation p.Val133Glu (c.398T>A) and the frameshift insertion p.Thr433Hisfs*116 (c.1296_1297insC) pathogenic because they alter the codon reading frame due to the insertion of a nucleotide (Table 2).

Table 1. Clinical characteristics of patients according to mutations in the *HNFLA* gene

	Mutation		P
	Present (n = 5)	Absent (n = 22)	
Sex			
Female	1 (20%)	15 (68.2%)	0.048
Male	4 (80%)	7 (31.8%)	
Age of diagnosis (years)	17.6 ± 6.8	21.5 ± 9.4	0.237
BMI* (kg/m ²)	22.08 ± 3.73	23.6 ± 2.6	0.154
Insulin use	1 (20%)	18 (81.8%)	0.006
OAD** use	3 (60%)	10 (45.4%)	0.557
Affected generations			
1	0	5 (22.7%)	0.054
2 or more	5 (100%)	17 (77.3%)	
Age of diagnosis/grade			
Childhood	0	3 (13.6%)	0.323
Adolescence	3 (60%)	6 (27.3%)	
Adult	2 (40%)	13 (59.1%)	
Diabetes presentation			0.583
Insidious	1 (20%)	3 (13.6%)	
Abrupt†	4 (80%)	19 (82.6%)	
Diabetes Duration (years)	8.6 ± 7.06	16.95 ± 10.13	0.432
MODY probability (PPV)	75.5 ± 0.0	35.7 ± 30.9	< 0.001
Mean insulin dose per kg of weight (units/kg)	0.37	0.9 ± 0.37	-

Note: Quantitative variables are presented as mean and standard deviation. Categorical variables are presented as total number (n) and percentage (%). The age groups used included the following: childhood, 0-9 years, adolescence, 10-19 years and adult, over 20 years (17).

* BMI: body mass index; ** OAD: oral anti diabetic drug; † Symptoms of insulinopenia such as polyuria, polydipsia and weight loss.

Copyright © 2014, All rights reserved.

Table 2. Mutations identified in this study

Gene	Exon	Patient	Change in protein	Change in DNA	Consequence	SIFT prediction	SIFT score	Polyphen	Mutation Taster prob.	ClinVar	Reference
<i>GCK</i>	2	P40	p.Tyr61Asp	c.181T>G	Missense	Deleterious	0	Probably harmful	0.999999998323156	NA	This study, novel
	4	P1	p.Phe150del	c.449_451delTCT	In-frame deletion	NA	NA	NA	0.999999999980624	NA	Massa and cols., 2001
	5	P7	p.Arg191Tyr	c.571C>T	Missense	Deleterious	0	Probably harmful	0.999999947468603	Pathogenic	Ellard and cols., 2000
	7	P29	p.Gly227Asp	c.680G>A	Missense	Deleterious	0	Probably damaging	0.99999999998095	NA	Dominguez-López and cols., 2013
	7	P9	p.Thr228Met	c.683C>T	Missense	Deleterious	0	Possibly harmful	0.9999999999911	Pathogenic	Stoffel and cols., 1992
	9	P32	p.Ala384Val	c.1151C>T	Missense	Tolerated	0.06	Possibly harmful	0.99999998673333	Uncertain meaning	Costantini and cols., 2014
<i>HNFL1A</i>	1	P4	p.Gly31Asp	c.92G>A	Missense	Tolerated	0.29	Possibly harmful	0.995035768629034	Pathogenic	Chèvre and cols., 1998
	2	P28	p.Val133Glu	c.398T>A	Missense	Deleterious	0	Possibly harmful	0.99999999738075	NA	This study, novel
	2	P13	p.Trp165Arg	c.493T>C	Missense	Deleterious	0	Possibly harmful	0.99999998737327	NA	Tatsi and cols., 2013
	2	P37	p.Arg171Ter	c.511C>T	Nonsense	NA	NA	NA	1	Pathogenic	Vaxillaire and cols., 1999
	6	P5	p.Thr433Hisfs*116	c.1296_1297insC	Frameshift-insertion	NA	NA	NA	1	NA	This study, novel

NA: not applicable; prob: probability of causing disease.

We recruited the family of all three probands with novel mutations, as presented in the pedigrees (Figure 1). We recruited four family members of the patient with the p.Tyr61Asp mutation in *GCK*. Then, we tested all four individuals with diabetes. The brother and sister had the same p.Tyr61Asp mutation, and we observed that it was inherited from the mother with diabetes. The father with recent onset DM (after 50 years of age) did not have the mutation. We recruited the mother with DM of the patient with the mutation p.Thr433Hisfs*116. She also had the same mutation. Four family members of the patient (three sisters and the mother) with the mutation p.Val133Glu in *HNFL1A* were recruited. The only sister with diabetes also had the same mutation of the patient, and they inherited the mutation from their healthy mother. We believe it may be a case of incomplete penetrance uncommon with *HNFL1A* mutations but already observed by other authors (14,15). In addition, the mutation p.Val133Glu was absent in the two healthy sisters.

MODY probability calculator

In the sample as a whole, 61.8% of patients (n = 21) had PPV > 50%, and 50% (n = 17) had PPV > 75%,

according to the MPC. In those with PPV > 50%, 47.6% had mutations, and in those with PPV > 75%, 52.9% had mutations.

HNFL1A group

The probability of MODY, according to MPC, was $\geq 50\%$ in 14 patients (51.8%) and $\geq 75\%$ in 11 patients (40.7%). All five patients in the *HNFL1A* group with mutations had PPV for MODY $\geq 75\%$ (Table 1). We found a mutation in 5/11 (45%) patients with PPV $\geq 75\%$ and in 5/14 (35.71%) of those with PPV $\geq 50\%$.

GCK group

Six patients had PPV $\geq 75\%$, and 1 had PPV between 50 and 75%. We detected *GCK* mutations in 5 patients with PPV $\geq 75\%$ and in patients with PPV between 50 and 75%, but not in 1 individual with PPV $\geq 75\%$.

DISCUSSION

In this study, we identified patients with phenotypes suggestive of MDM and performed mutation screening for *GCK* and *HNFL1A* genes. We found mutations in 32.3%

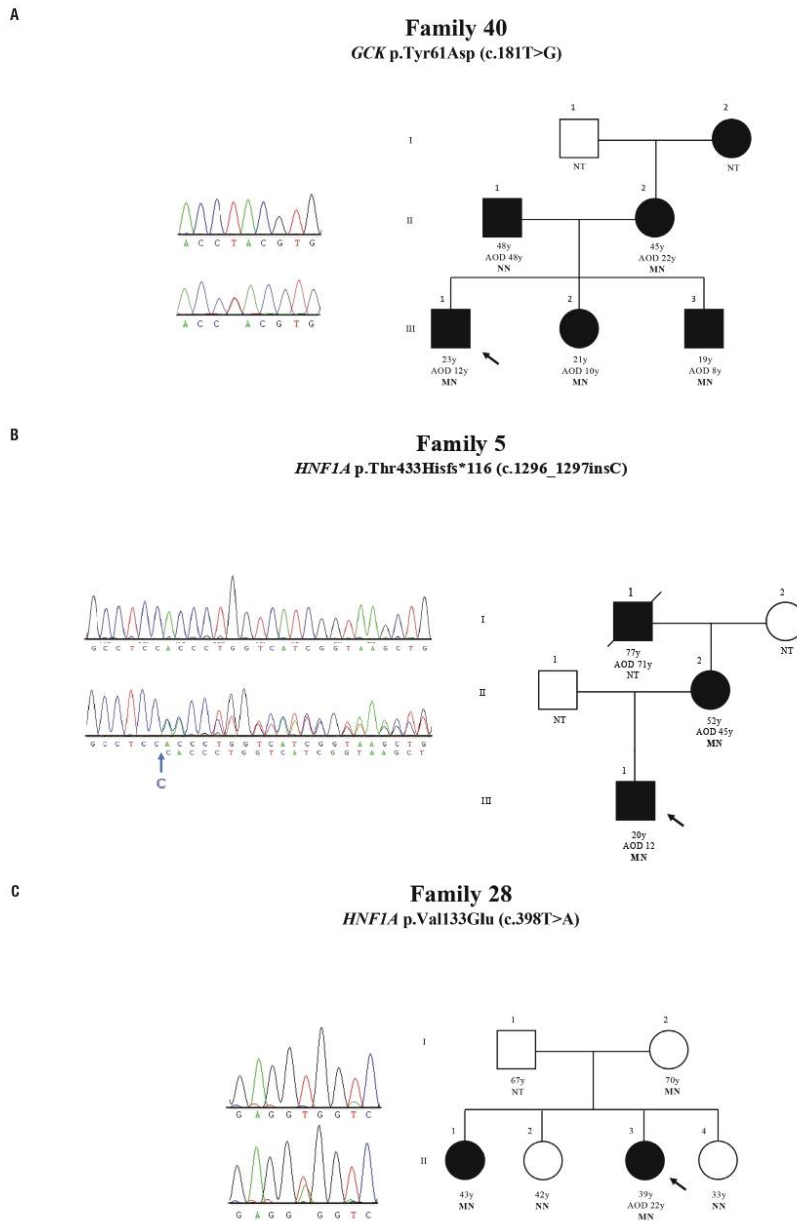

Figure 1. Pedigree and genotype of novel mutations. **(A)** Family 40 with the *GCK* p.Tyr61Asp (c.181T>G) in heterozygous state. K: allele T or G. **(B)** Family 5 showing the novel insertion *HNF1A* p.Thr433Hisfs*116 (c.1296_1297insC). The blue arrow indicates where the insertion occurs. **(C)** Family 28 presenting the *HNF1A* p.Val133Glu (c.398T>A). W: allele T or A. Filled symbols and empty symbols represent subjects with diabetes and healthy individuals, respectively. The present age of the individuals is show below the symbols in years, followed by age of diagnosis (AOD) in years and genotype interpretation. Genotypes are expressed by normal allele (N) and mutated allele (M); NT: Not tested. An arrow indicates the index case.

Copyright: Arch Endocrinol Metab

Although a high frequency of mutations in these two genes have been reported in individuals with a clinical diagnosis of MDM from several populations, especially from Northern Europe (16,17), others (including Southern Europeans, Asians and Brazilians) have found a lower frequency of mutations, as true with our findings (18-21). In some populations, other types of diabetes might share clinical features with MDM more frequently than others. Alternatively, other genes implicated in the pathogenesis of MODY could be more frequent in these groups, such as *HNF4A*, insulin promoter factor-1 (*IPF-1*), *HNF1B*, *NeuroDI* and others. In the other two studies with Brazilian cohorts (20,21), approximately 60% of patients with clinical suspicion of MDM did not have mutations in *HNF1A*, *GCK* or *HNF4A* genes, but we did not test other MODY genes.

In those with mild fasting hyperglycemia, we found *GCK* mutations in 85.7%, which suggests a high sensitivity for the clinical criteria. The frequency of *GCK* mutations in this study was slightly higher than previously reported for most populations (42.4 to 61%), including Brazilians (21-23). We found mutations in *HNF1A*, the most common gene for non-*GCK* MDM, in 18.5%, which was much like the data obtained by Santana and coworkers in the Brazilian population but lower than reported in other populations (16-19,24). Therefore, the clinical criteria for the selection of patients for *GCK* testing seem to be adequate in most populations, including ours. Surprisingly, we found the opposite for non-*GCK* MODY. This suggests that an improvement in the clinical criteria to adequately select patients for screening is necessary or that, alternatively, other genes should also be investigated.

We have evaluated if MPC (8) could help identify a group of patients that would be more suitable for screening. All patients with *HNF1A* mutations had PPV > 75%. If we had selected only subjects above this cutoff, 60% of the patients would not have been tested. This strategy would make the screening more cost-effective. However, the frequency of mutations in other genes in patients with a clinical diagnosis of non-*GCK* MODY is still not known for our population. It is possible that patients without *HNF1A* mutations could have alterations in other MODY genes, which would be overlooked with this strategy.

In this study, a cutoff for MODY probability of > 75% and >62%, based on MPC, was found in all patients with *HNF1A* and *GCK* mutations, respectively. Although in UK the current pick-up rate for MODY

testing is PPV > 25% (9), other authors have found a good specificity and negative predictive value in higher cutoff values (> 62.5%) for detecting MODY in non-Caucasian population (25). Our findings suggest that higher cutoff values should be considered for MODY screening in non-Caucasian populations.

This study has some limitations. First, we included a limited number of patients. Secondly, we tested only two MODY genes for financial reasons. Additionally, we used only one methodology (Sanger sequencing) to investigate mutations. This method is unable to detect copy number variations, large deletions and duplications that can represent up to 3% of all genetic alterations of the *GCK*, *HNF1A* and *HNF4A* (26). Another concern is related to the absence of a control group. The selection of the studied population was done in a pragmatic way when the patient did not present clinical criteria of T1 or T2 DM. An additional potential limitation is the lack of C-peptide measurement as a screening tool for MODY. The strengths of our study included finding three novel mutations not previously reported and providing new information about the screening of monogenic diabetes in individuals with multiethnic backgrounds. For future studies, we aim to bypass these limitations and to perform functional genomic studies to confirm novel mutations as pathogenic ones.

In conclusion, we investigated MODY mutations in patients with clinical features suggestive of MDM from a multiethnic background. Approximately one third of patients with clinical features suggestive of MDM from a multiethnic background had *GCK* or *HNF1A* mutations. While clinical criteria were efficient for detecting patients with *GCK* mutations, we found *HNF1A* mutations in less than 20% of the cases. Although MPC has not been validated for non-Caucasians, its use as a screening tool for selecting patients to test for *HNF1A* mutations, using a cutoff of 75%, would reduce the number of tests in 60% and increase the percentage of positive cases to 45%. These data suggest that the use of the MPC could be a cost-effective strategy for selecting patients to screening for non-*GCK* MODY mutations, but it is important to consider the possible role of non-*HNF1A* mutations in non-Caucasian populations such as ours.

Acknowledgements: professor Tânia Maria Ruffoni Ortiga, from the Laboratory of Translational Endocrinology of the Biophysics Institute Carlos Chagas Filho, and professor Márcia Mattos Gonçalves Pimentel, head of the Human Genetics Service of State University of Rio de Janeiro, who assisted in the initial phases of the research.

Contributions: RMT was the physician responsible for recruiting patients in the study, gathering and analyzing the data and writing the manuscript. GMA was responsible for the molecular genetics and bioinformatic analysis. ACPF contributed to statistical analysis of the data. RK reviewed the manuscript. FC reviewed the manuscript. MC reviewed and edited the manuscript. LZ contributed to the discussion. MR reviewed and edited the manuscript and contributed to the discussion. The authors are grateful to the patients and their families, as well as to all the authors who approved the final version of this article.

Funding: this work was supported by National Council for Scientific and Technological Development (CNPq) and Oswaldo Cruz Institute (IOC).

Disclosure: RMT has been a Novo Nordisk employee (i.e., regional medical advisor) since July 2017 but started the monogenic diabetes research project in 2012 and judges that it could not inappropriately influence (bias) this work. The other authors have no declarations of interest.

REFERENCES

- Kropff J, Selwood MP, McCarthy MI, Farmer AJ, Owen KR. Prevalence of monogenic diabetes in young adults: a community-based, cross-sectional study in Oxfordshire, UK. *Diabetologia*. 2011;54(5):1261-3.
- Ellard S, Bellanne-Chantelot C, Hattersley AT; European Molecular Genetics Quality Network (EMQN) MODY group. Best practice guidelines for the molecular genetic diagnosis of maturity-onset diabetes of the young. *Diabetologia*. 2008;51(4):546-53.
- Van der Zwaag AM, Weinreich SS, Bosma AR, Rigter T, Losekoot M, Henneman L, et al. Current and best practices of genetic testing for maturity onset diabetes of the young: views of professional experts. *Public Health Genomics* 2015;18(1):52-9.
- Tattersall RB. Mild familial diabetes with dominant inheritance. *Q J Med*. 1974;43(170):339-57.
- Thanabalasingham G, Owen KR. Diagnosis and management of maturity onset diabetes of the young (MODY). *BMJ*. 2011;343:d6044.
- Naylor RN, John FM, Winn AN, Carmody D, Greeley SA, Philipson LH, et al. Cost-effectiveness of MODY genetic testing: translating genomic advances into practical health applications. *Diabetes Care*. 2014;37(1):202-9.
- Shields BM, Hicks S, Shepherd MH, Colclough K, Hattersley AT, Ellard S. Maturity-onset diabetes of the young (MODY): how many cases are we missing? *Diabetologia*. 2010;53(12):2504-8.
- Shields BM, McDonald TJ, Ellard S, Campbell MJ, Hyde C, Hattersley AT. The development and validation of a clinical prediction model to determine the probability of MODY in patients with young-onset diabetes. *Diabetologia*. 2012;55(5):1265-72.
- Murphy R, Ellard S, Hattersley AT. Clinical implications of a molecular genetic classification of monogenic beta-cell diabetes. *Nat Clin Pract Endocrinol Metab*. 2008;4(4):200-13.
- McDonald TJ, Ellard S. Maturity onset diabetes of the young: identification and diagnosis. *Ann Clin Biochem*. 2013;50(Pt 5):403-15.
- Ng PC, Henikoff S. SIFT: Predicting amino acid changes that affect protein function. *Nucleic Acids Res*. 2003;31(13):3812-4.
- Sunyaev S, Ramensky V, Koch I, Lathe W 3rd, Kondrashov AS, Bork P. Prediction of deleterious human alleles. *Hum Mol Genet*. 2001;10(6):591-7.
- Schwarz JM, Cooper DN, Schuelke M, Seelow D. MutationTaster2: mutation prediction for the deep-sequencing age. *Nat Methods*. 2014;11(4):361-2.
- Hansen T, Eiberg H, Rouard M, Vaxillaire M, Møller AM, Rasmussen SK, et al. Novel MODY3 mutations in the hepatocyte nuclear factor-1alpha gene: evidence for a hyperexcitability of pancreatic beta-cells to intravenous secretagogues in a glucose-tolerant carrier of a P447L mutation. *Diabetes*. 1997;46(4):726-30.
- Elbein SC, Teng K, Yount P, Scroggin E. Linkage and molecular scanning analyses of MODY3/hepatocyte nuclear factor-1 alpha gene in typical familial type 2 diabetes: evidence for novel mutations in exons 8 and 10. *J Clin Endocrinol Metab*. 1998;83(6):2059-65.
- Frayling TM, Bulamn MP, Ellard S, Appleton M, Dronsfield MJ, Mackie AD, et al. Mutations in the hepatocyte nuclear factor-1alpha gene are a common cause of maturity-onset diabetes of the young in the U.K. *Diabetes*. 1997;46(4):720-5.
- Estalilla I, Rica I, Perez de Nanclares G, Bilbao JR, Vazquez JA, San Pedro JI, et al.; Spanish MODY Group. Mutations in GCK and HNF-1alpha explain the majority of cases with clinical diagnosis of MODY in Spain. *Clin Endocrinol (Oxf)*. 2007;67(4):538-46.
- Johansen A, Ek J, Mortensen HB, Pedersen O, Hansen T. Half of clinically defined maturity-onset diabetes of the young patients in Denmark do not have mutations in HNF4A, GCK, and TCF1. *J Clin Endocrinol Metab*. 2005;90(8):4607-14.
- Kyithar MP, Bacon S, Pannu KK, Rizvi SR, Colclough K, Ellard S, et al. Identification of HNF1A-MODY and HNF4A-MODY in Irish families: phenotypic characteristics and therapeutic implications. *Diabetes Metab*. 2011;37(6):512-9.
- Moises RS, Reis AF, Morel V, Chacra AR, Dib SA, Bellanne-Chantelot C, et al. Prevalence of maturity-onset diabetes of the young mutations in Brazilian families with autosomal-dominant early-onset type 2 diabetes. *Diabetes Care*. 2001;24(4):786-8.
- Santana LS, Caetano LA, Costa-Riquetto AD, Quedas EPS, Nery M, Collett-Solberg P, et al. Clinical application of ACMG-AMP guidelines in HNF1A and GCK variants in a cohort of MODY families. *Clin Genet*. 2017;92(4):388-96.
- Carmody D, Naylor RN, Bell CD, Berry S, Montgomery JT, Tadie EC, et al. GCK-MODY in the US National Monogenic Diabetes Registry: frequently misdiagnosed and unnecessarily treated. *Acta Diabetol*. 2016;53(5):703-8.
- Capuano M, Garcia-Herrero CM, Tinto N, Carluccio C, Capobianco V, Coto I, et al. Glucokinase (GCK) mutations and their characterization in MODY2 children of southern Italy. *PLoS One*. 2012;7(6):e38906.
- Giuffrida FMA, Moises RS, Weinert LS, Calliari LE, Manna TD, Dotto RP, et al on behalf of the Brazilian Monogenic Diabetes Study Group (BRASMOD). Maturity-onset diabetes of the young (MODY) in Brazil: Establishment of a national registry and appraisal of available genetic and clinical data. *Diabetes Res and Clin Pract*. 2017;123:134-42.
- Ang SF, Lim SC, Tan CSH, Fong JC, Kon WY, Lian JX, Subramaniam T, Sum CF. A preliminary study to evaluate the strategy of combining clinical criteria and next generation sequencing (NGS) for the identification of monogenic diabetes among multi-ethnic Asians. *Diabetes Res Clin Pract*. 2016;119:13-22.
- Ellard S, Thomas K, Edghill EL, Owens M, Ambye L, Cropper J, et al. Partial and whole gene deletion mutations of the GCK and HNF1A genes in maturity-onset diabetes of the young. *Diabetologia*. 2007;50(11):2313-7.

Capítulo II

“The first case of NEUROD1-MODY reported in Latin America”

Mutações no gene *NEUROD1* são causas raras de diabetes monogênico em todo mundo. No próximo capítulo realizamos um levantamento bibliográfico onde descrevemos menos de 20 casos reportados de NEUROD1-MODY, sendo estes de origem Europeia e Asiática. Neste estudo relatamos o primeiro caso de NEUROD1-MODY da América Latina. Identificamos uma nova variante do tipo que altera o quadro de leitura segregando em uma família Brasileira. Posteriormente descrevemos as características clínicas dos pacientes e comparamos com as informações clínicas descritas dos probandos com modificações no *NEUROD1* nas outras populações.

Publicado na revista: *Molecular Genetics and Genomic Medicine* 2019; 7(12):e989.

The first case of NEUROD1-MODY reported in Latin America

Gabriella de Medeiros Abreu¹ | Roberta Magalhães Tarantino^{2,3} | Pedro Hernan Cabello^{1,4} |
Verônica Marques Zembrzusi¹ | Ana Carolina Proença da Fonseca¹ | Melanie Rodacki² |
Lenita Zajdenverg² | Mário Campos Junior¹ 

¹Human Genetics Laboratory, Oswaldo Cruz Institute, Oswaldo Cruz Foundation, Rio de Janeiro, Brazil

²Diabetes and Nutrology Section, Internal Medicine Department, Federal University of Rio de Janeiro, Rio de Janeiro, Brazil

³Ambulatory of Diabetes, State Institute of Diabetes and Endocrinology, Rio de Janeiro, Brazil

⁴Laboratory of Genetics, School of Health Science, Grande Rio University, Rio de Janeiro, Brazil

Correspondence

Mário Campos Junior, Oswaldo Cruz Institute, Oswaldo Cruz Foundation, Rio de Janeiro, Brazil.
Email: mario.junior@ioc.fiocruz.br

Funding information

National Council for Scientific and Technological Development; Coordination for the Improvement of Higher Education Personnel; Oswaldo Cruz Institute

Abstract

Background: MODY-NEUROD1 is a rare form of monogenic diabetes caused by mutations in *Neuronal differentiation 1 (NEUROD1)*. Until now, only a few cases of MODY-NEUROD1 have been reported worldwide and the real contribution of mutations in *NEUROD1* in monogenic diabetes and its clinical impact remain unclear.

Methods: Genomic DNA was isolated from peripheral blood lymphocytes of 25 unrelated Brazilians patients with clinical characteristics suggestive of monogenic diabetes and the screening of the entire coding region of *NEUROD1* was performed by Sanger sequencing.

Results: We identified one novel frameshift deletion (p.Phe256Leufs*2) in *NEUROD1* segregating in an autosomal dominant inheritance fashion. Almost 20 years after the first report of NEUROD1-MODY, only a few families in Europe and Asia had shown mutations in *NEUROD1* as the cause of monogenic diabetes.

Conclusion: To our knowledge, we described the first case of NEUROD1-MODY in a Latin American family.

KEYWORDS

diabetes mellitus, MODY, MODY6, monogenic diabetes, NEUROD1

1 | INTRODUCTION

Neuronal differentiation 1 (NEUROD1) – Gene ID: 4760 – OMIM *601724, also known as *BETA2*, encodes a basic helix-loop-helix (bHLH) transcription factor that heterodimerizes with the ubiquitous bHLH protein E47 and regulates insulin gene (*INS*) expression through binding to its E-box motif promoter (Naya, Stellrecht, & Tsai, 1995). In 1999, mutations in *NEUROD1* were associated to early onset type 2 diabetes mellitus (DM) in two European descendent families inherited in an autosomal dominant fashion for the first time (Malecki et al., 1999), being further classified as maturity-onset diabetes of the young type 6 (MODY6; OMIM

#606394) (Fajans, Bell, & Polonsky, 2001). Almost 20 years after the first report, only a few families in Europe (Ağladioglu et al., 2016; Gonsorčková et al., 2008; Kristinsson et al., 2001; Szopa et al., 2016) and Asia (Ang et al., 2016; Chapla et al., 2015; Doddabelavangala Mruthyunjaya et al., 2017; Horikawa et al., 2018; Liu et al., 2007) had shown mutations in *NEUROD1* as the cause of diabetes.

Epidemiological studies of monogenic diabetes are scarce in multiethnic populations, such as Brazilian. This population is very diverse and comprises individuals of multiple ethnic backgrounds and racial admixture, especially Caucasians and Afro-descendants. Studies aiming the rare forms of monogenic diabetes are needed in a mixed population and, to the best of our

This is an open access article under the terms of the Creative Commons Attribution-NonCommercial License, which permits use, distribution and reproduction in any medium, provided the original work is properly cited and is not used for commercial purposes.
© 2019 The Authors. *Molecular Genetics & Genomic Medicine* published by Wiley Periodicals, Inc.

Mol Genet Genomic Med. 2019;00:e989.
<https://doi.org/10.1002/mgg3.989>

wileyonlinelibrary.com/journal/mgg3 | 1 of 6

knowledge, this is the first case to report a *NEUROD1* mutation in a Latin American family.

2 | MATERIALS AND METHODS

2.1 | Ethical compliance

The Ethics and Research Committee of the Clementino Fraga Filho University Hospital approved this study protocol (No. 70238). All participants were informed about the aim of this study and provided verbal and written consent according to Helsinki Declaration.

2.2 | Patients

In this cross-sectional observational study, we selected 25 unrelated Brazilian probands negative for *GCK* or *HNF1A*, *HNF4A*, and *HNF1B* mutations. The inclusion criteria were age at onset ≤ 35 years, BMI (body mass index) < 30 kg/m² or 95th percentile at the diagnosis; a positive family history of diabetes in at least two generations; negative β -cells anti-glutamic acid decarboxylase (anti-GAD) and anti-IA-2 autoantibodies. We excluded patients with type 1 diabetes, history of diabetic ketoacidosis, clinical signs of insulin resistance, and presence of secondary causes of diabetes.

2.3 | Molecular screening

Genomic DNA was isolated from peripheral blood leukocytes using QIAamp DNA Blood Mini Kit (Qiagen) and from the family members who accepted to participate in this study, we extracted genomic DNA from buccal epithelial cells (Aidar & Line, 2007). The screening of the entire coding region of *NEUROD1* was carried out by amplification of two overlapping fragments using two pairs of primers (primers available upon request; RefSeq NG_011820.2, NM_002500.4 and NP_002491.2). Polymerase chain reaction (PCR) products were purified by Clean Sweep PCR Purification Reagent (Applied Biosystems) and bidirectional Sanger sequencing was performed using the Big Dye Terminator Kit v3.1 (Applied Biosystems), conducted on an ABI 3130 Automatic Genetic Analyzer (Applied Biosystems).

3 | RESULTS

The entire coding region of *NEUROD1* was screened in a cohort of 25 unrelated Brazilian patients with clinical suspicious of monogenic diabetes (10 males and 15 females; average age at diagnosis: 22.68 ± 8.9 years; BMI average: 24.8 ± 4.54 kg/m²), previously tested and negative for

mutation in *GCK*, *HNF1A*, *HNF4A*, and *HNF1B* (data not published).

We detected one novel frameshift deletion of two thymine resulting in a change from phenylalanine to leucine in the position 256 of the protein, followed by a premature stop codon (p.Phe256Leufs*2). This deletion was not seen in the remaining 24 patients and in ClinVar, dbSNP, HGMD®, ExAC Browser, GnomAD, 1000 Genomes project databases, and in the literature. Mutation Taster predicted p.Phe256Leufs*2 to be the disease-causing mutation (score 1). The mutation is located in the transactivation domain, a highly conserved domain across several species (Figure 1).

The p.Phe256Leufs*2 mutation was found in a Brazilian family segregating in an autosomal dominant pattern from the maternal side (Figure 2). The index case is a 33 years old man who was diagnosed with diabetes at 25 years of age after some months of polyuria, polydipsia, and weight loss of approximately 10 kg (BMI at diagnostic: 28.9 kg/m²). He was included in this study at 30 years with mean fasting glucose of 137 mg/dl and glycated hemoglobin (HbA1c-HPLC) of 7.5% (HbA1c at diagnosis: 6.5%). He presented no diabetic microvascular complications such as retinopathy (normal funduscopy), diabetic renal disease (normal renal ultrasound and negative microalbuminuria), and neuropathy after 8 years of manifestation of disease.

At diagnosis, the index case was treated with metformin 2 g/day. One month later, since he presented poor glycemic control, he started being treated with NPH insulin (0.2 UI/kg). After 4 years with the same low dose of NPH insulin, a detectable basal C-peptide and a good glycemic control with insulin (HbA1c: 6%), his treatment was changed to glimepiride and metformin, since he presented some hypoglycemic episodes during these years. Nowadays he presents good glycemic control using glimepiride 6 mg/day and metformin 2 g/day (HbA1c: 6.6%), and fewer episodes of hypoglycemia. The only comorbidity is hypertension and it is well controlled with nitrendipine 20 mg/day, losartan 100 mg/day, and atenolol 25 mg/day and the major causes of secondary hypertension were excluded (Cushing's syndrome, pheochromocytoma, primary hyperaldosteronism, and renal-artery stenosis). He never had diabetic ketoacidosis and was negative for anti-GAD and anti-IA-2 autoantibodies.

The patient's mother (BMI: 19.9 kg/m²) was diagnosed with diabetes at the age of 23 years with a mean fasting glucose of 330 mg/dl and since then, she had been on basal insulin therapy (mean fasting glucose: 113 mg/dl; HbA1c: 9.4%). She developed diabetic retinopathy and nephropathy. The index case's sister (BMI 18.9 kg/m²) was diagnosed with accidental hyperglycemia at the age of 26 years, with mean fasting glucose of 250 mg/dl; During the first 2 years she was initiated with NPH insulin, then

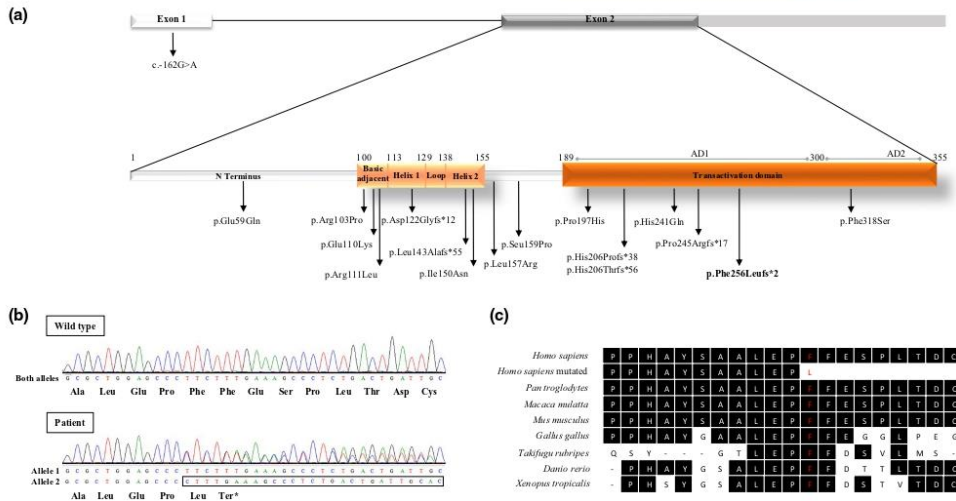
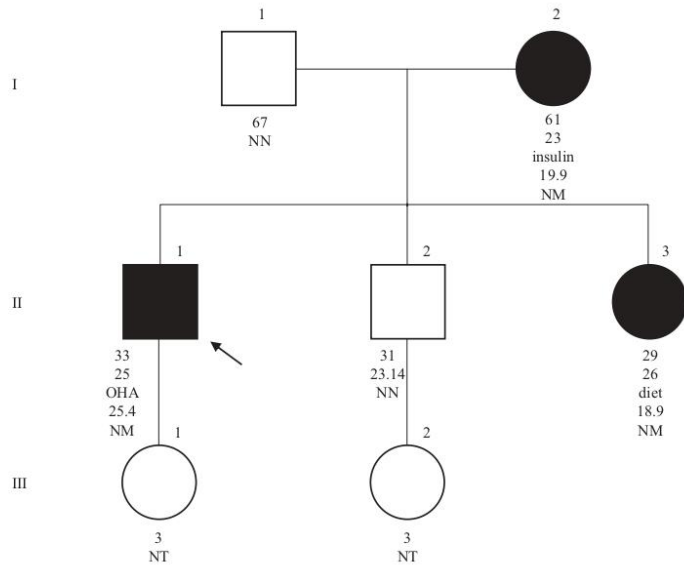

FIGURE 1 *NEUROD1* mutations previously identified in diabetic patients and the novel p.Phe256Leufs*2 mutation. (a) Diagrammatic representation of *NEUROD1* and *NEUROD1* protein structure. *NEUROD1* presents two exons, being exon 1 noncoding. *NEUROD1* protein contains two domains: basic helix-loop-helix domain, which is divided in basic adjacent, helix 1, loop and helix 2; and transactivation domain, which has two activating domains (AD1 and AD2). Arrows indicate the position of mutations described in the literature and in this study (bold). (b) Electropherograms of *NEUROD1* exon 2 wild type (above) and p.Phe256Leufs*2 identified in the patient DM24 (below). (c) Alignment of *NEUROD1* across species shows amino acid 256 (in red) evolutionary conserved across species

FIGURE 2 Pedigree, clinical characteristics, and genotype of family 24. Filled symbols and empty symbols represent diabetic patients and healthy individuals, respectively. The present age of the individuals is shown below the symbols, followed by the age at diagnosis, the most recent treatment, body mass index (kg/m^2) and genotype interpretation. OHA, oral hypoglycemic agents; Genotypes are expressed by normal allele (N) and mutated allele (M); NT, not tested. An arrow indicates the index case



with gliclazide 30 mg/day and lastly, with 29 years, her glucose levels were managed only with low-carbohydrate diet and exercise (mean fasting glucose: 97 mg/dl; HbA1c:

6.2%; C-peptide: 2.3 ng/ml). To this moment, the index case and his family members did not present neurological abnormalities.

TABLE 1 Clinical characteristics of known and novel *NEUROD1* mutations associated to monogenic diabetes

Protein level	c.DNA level	Accession number	Mutation type	Domain	Origin	Sample (%)	Sample type	Met.	Age (years)	AOD (years)	DT	Ref.
p.Arg111Leu	c.332G>T	rs104893649	Missense	Basic adjacent	European	2/94 (2.12)	Type 2 DM	Sanger sequencing	65	40	Insulin	(Malecki et al., 1999)
p.His206Profs*38	c.616_617ins	rs387906384	Frameshift	AD1	descendent				74	33	Insulin	(Kristinsson et al., 2001)
p.Glu110Lys	c.328C>A	rs763092306	Missense	Basic adjacent	Iceland	1/3	MODY Families	Sanger sequencing	N/A	N/A	N/A	(Lin et al., 2007)
p.Ser159Pro	c.475T>C	N/A	Missense	N/A	China	1/85 (1.17)	Type 2 DM	Sanger sequencing	27	27	OHA	
p.His241Gln	c.723C>G	rs561017686	Missense	AD1	Czech Republic	2/30 (6.66)	MODY	Sanger sequencing	44 ^a	20	Insulin	(Gonsorčiková et al., 2008)
p.Asp122Glyfs*12	c.364_365ins	N/A	Frameshift	Helix 1	Pakistan	2/44 (4.54)	PNDM	Sanger sequencing	N/A	8 ^b	N/A	(Rubio-Cabezas et al., 2010)
p.Leu143Alafs*55	c.427_428del	rs1485945978	Frameshift	Helix 2	Hungary				N/A	4 ^b	N/A	
p.Pro197His	c.590C>A	rs8192556	Missense	AD1	Turkish	2/43 (4.65)	MODY	NGS panel	15	14	Diet	(Agladlogh et al., 2016)
p.His241Gln	c.723C>G	rs561017686	Missense	AD1	India	4/56 (7.14)	MODY	NGS panel	47	28	OHA	(Chapla et al., 2015)
p.Glu59Gln	c.175G>C	rs553756272	Missense	N terminus					35	24	OHA + insulin	
NA	c.-162G>A	rs537184640	NA	5'UTR					30	30	OHA	
p.Arg103Pro	c.308G>C	N/A	Missense	Basic adjacent	Poland	1/156 (0.64)	MODY	NGS panel	66	23	Insulin	(Szopa et al., 2016)
p.Pro197His	c.590C>A	rs8192556	Missense	AD1	Asian	1/84 (1.19)	MODY	NGS panel	N/A	N/A	N/A	(Ang et al., 2016)
p.Glu59Gln	c.175G>C	rs553756272	Missense	N terminus	India	2/50 (4)	GDM	NGS panel	36	36	OHA	(Doddabellavangala Mruthyunjaya et al., 2017)
p.Phe318Ser	c.953T>C	N/A	Missense	AD2					29	27	OHA	
p.His206Profs*38	c.616_617ins	rs387906384	Frameshift	AD1	Japan	4/275 (1.45)	MODY	Sanger sequencing	17	14	Insulin	(Horikawa et al., 2018)
p.Pro245Argfs*17	c.734_734del	N/A	Frameshift	AD1					25	11	Insulin	
p.Leu157Arg	c.470T>G	N/A	Missense	N/A					24	10	OHA + insulin	
p.His206Thrfs*56	c.616_616del	N/A	Frameshift	AD1					15	12	OHA + insulin	
p.Ile150Asn	c.449T>A	N/A	Missense	Helix 2	Turkish	1	PNDM family	NGS panel	13.4	9 ^b	Insulin	(Demirbilek et al., 2018)
p.Phe256Leufs*2	c.766_767del	N/A	Frameshift	AD1	Brazil	1/25 (4)	MODY	Sanger sequencing	30	25	OHA	^c

Abbreviations: AD, activating domain; AOD, age of diagnosis; DM, diabetes mellitus; DT, diabetes treatment; GDM, gestational diabetes mellitus; Met, methodology; N/A, not available/not applicable; OHA, oral hypoglycemic agents; PNDM, permanent neonatal diabetes mellitus; Ref., references; UTR, untranslated.

^aAge at death.

^bWeeks.

^cNovel mutation identified in this study.

The mutation p.Phe256Leufs*2 was not present in the proband's brother, a normal weight (BMI: 23.14 kg/m²) man of 31 years. Levels of glucose and HbA1c were 113 mg/dl and 5.6%, respectively.

4 | DISCUSSION

The genetic diagnosis of MODY in Brazil has been mostly limited to *GCK* and *HNF1A*, after a selection for testing guided by clinical criteria (Giuffrida et al., 2017). For this reason, rare forms are poorly studied. In this work, we screened all coding region of *NEUROD1* in patients with clinical phenotype of monogenic diabetes, negative for mutations in *GCK*, *HNF1A*, *HNF4A* and *HNF1B*.

After almost two decades past from the initial report of *NEUROD1*-MODY (Malecki et al., 1999), only a small numbers of Asian and European families were identified (Ağlıadioğlu et al., 2016; Ang et al., 2016; Chapla et al., 2015; Doddabelavangala Mruthyunjaya et al., 2017; Gonsorčíková et al., 2008; Horikawa et al., 2018; Kristinsson et al., 2001; Liu et al., 2007; Szopa et al., 2016). In these populations, *NEUROD1* mutations range from low frequencies as in Poland (0.64%; Szopa et al., 2016) to high frequencies as in India (7.14%; Chapla et al., 2015). In our study, we found a frequency of 4%, similar to that observed in Turkish (4.65%; Ağlıadioğlu et al., 2016; Table 1).

So far, 20 index cases with monogenic diabetes were previously reported with heterozygous mutations in *NEUROD1* and the data collection shows an average age of diagnosis (AOD) of 23.37 ± 9 years (ranging 10–40 years), similar to our patient's AOD (25 years). The treatment varied among patients, the use of oral hypoglycemic agents (OHA) was the most frequent (36.8%), followed by insulin (31.6%), OHA + insulin (21.1%) and diet (10.5%). Interestingly, all probands with frameshift mutations were treated with insulin (Table 1).

NEUROD1 is a transcription factor expressed in pancreatic cells (Naya et al., 1997), and mutations that cause a disturbance in this protein lead to the hyperglycemia that was observed in all index cases. It is also expressed in neuronal cells (Naya et al., 1997), which could explain the neuronal manifestations observed in two patients with p.Pro197His mutation in heterozygosity described with pituitary hypoplasia, growth hormone deficiency and epilepsy (Ağlıadioğlu et al., 2016). Mental retardation was observed in a female patient and her mother, both carrying p.Pro245Argfs*17 (Horikawa et al., 2018). Besides, Rubio-Cabezas et al. (2010) identified two probands with p.Asp122Glyfs*12 and p.Leu143Alafs*55 frameshift mutations in homozygosity leading to the syndrome of permanent neonatal DM (PNDM) and neurological abnormalities including developmental delay, sensorineural deafness, and

visual impairment (Rubio-Cabezas et al., 2010). Demirbilek et al. (2018) recently described a novel case of PNDM in a 13-year-old girl with a homozygous missense mutation (p.Ile150Asn) showing a similar clinical presentation from the previously reported PNDM cases (Demirbilek et al., 2018; Rubio-Cabezas et al., 2010).

Additionally, Horikawa and Enya (2019) observed that there are two times more affected female patients than affected male patients among the cases described and that the majority of the cases inherited the mutation from their mother, which was also observed in this study. Further analysis on the pathophysiology of *NEUROD1* will help to clarify the reason of this discrepancy in an autosomal disease (Horikawa & Enya, 2019).

To the best of our knowledge, this is the first case reported to have a *NEUROD1*-MODY mutation in a Latin American cohort. The novel p.Phe256Leufs*2 mutation in the activating domain 1 has similar structural effects in the protein as those caused by the first reported p.His206Profs*38 mutation (Malecki et al., 1999). It leads to the loss of 60% of the transactivation domain, and likely that p.His206Profs*38, probably has a compromised biological activity since the transactivation domain is required for the ligation of *NEUROD1* with the coactivator p300 (Qiu, Sharma, & Stein, 1998). The majority of mutations found in *NEUROD1* associated with monogenic diabetes (13 cases [54.2%]) is located in the transactivation domain, comprising four frameshift mutations (Horikawa et al., 2018; Malecki et al., 1999) and three missense mutations (Ağlıadioğlu et al., 2016; Ang et al., 2016; Chapla et al., 2015; Doddabelavangala Mruthyunjaya et al., 2017; Gonsorčíková et al., 2008; Figure 1).

This study has some limitations. First, our sample size was small and may not show the real frequency of *NEUROD1* mutations as cause of monogenic diabetes in our population. In addition, we did not analyze the possible presence of copy number variations that could also be compromising *NEUROD1* function and would not be observed in our sequencing method.

5 | CONCLUSION

In conclusion, we described a Brazilian family with a novel mutation in *NEUROD1* segregating with diabetes in an autosomal dominant pattern of inheritance.

ACKNOWLEDGMENTS

The authors are grateful to the patients and their families. This work was supported by National Council for Scientific and Technological Development (CNPq), Coordination for the Improvement of Higher Education Personnel (CAPES), and Oswaldo Cruz Institute (IOC).

CONFLICT OF INTEREST

None declared.

ORCID

Mário Campos Junior  <https://orcid.org/0000-0002-7121-0748>

REFERENCES

- Ağladioğlu, S. Y., Aycan, Z., Çetinkaya, S., Baş, V. N., Önder, A., Peltek Kendirci, H. N., ... Ceylaner, S. (2016). Maturity onset diabetes of youth (MODY) in Turkish children: Sequence analysis of 11 causative genes by next generation sequencing. *Journal of Pediatric Endocrinology and Metabolism*, 29(4), 487–496. <https://doi.org/10.1515/jpem-2015-0039>
- Aidar, M., & Line, S. R. (2007). A simple and cost-effective protocol for DNA isolation from buccal epithelial cells. *Brazilian Dental Journal*, 18(2), 148–152. <https://doi.org/10.1007/BF01811861>
- Ang, S. F., Lim, S. C., Tan, C. S. H., Fong, J. C. W., Kon, W. Y. C., Lian, J. X., ... Sum, C. F. (2016). A preliminary study to evaluate the strategy of combining clinical criteria and next generation sequencing (NGS) for the identification of monogenic diabetes among multi-ethnic Asians. *Diabetes Research and Clinical Practice*, 119, 13–22. <https://doi.org/10.1016/j.diabres.2016.06.008>
- Chapla, A., Mruthyunjaya, M. D., Asha, H. S., Varghese, D., Varshney, M., Vasani, S. K., ... Thomas, N. (2015). Maturity onset diabetes of the young in India – A distinctive mutation pattern identified through targeted next-generation sequencing. *Clinical Endocrinology*, 82(4), 533–542. <https://doi.org/10.1111/cen.12541>
- Demirbilek, H., Hatipoğlu, N., Gul, U., Tatli, Z. U., Ellard, S., Flanagan, S. E., ... Kurtoglu, S. (2018). Permanent neonatal diabetes mellitus and neurological abnormalities due to a novel homozygous missense mutation in NEUROD1. *Pediatric Diabetes*, 19(5), 898–904. <https://doi.org/10.1111/peidi.12669>
- Doddabelavangala Mruthyunjaya, M., Chapla, A., Hesarghatta Shyamasunder, A., Varghese, D., Varshney, M., Paul, J., ... Thomas, N. (2017). Comprehensive maturity onset diabetes of the young (MODY) gene screening in pregnant women with diabetes in India. *PLoS ONE*, 12(1), e0168656. <https://doi.org/10.1371/journal.pone.0168656>
- Fajans, S., Bell, G., & Polonsky, K. (2001). Molecular mechanisms and clinical pathophysiology of maturity-onset diabetes of the young. *The New England Journal of Medicine*, 345(13), 971–980. <https://doi.org/10.1056/NEJMra002168>
- Giuffrida, F. M. A., Moises, R. S., Weinert, L. S., Calliari, L. E., Manna, T. D., Dotto, R. P., ... Reis, A. F. (2017). Maturity-onset diabetes of the young (MODY) in Brazil: Establishment of a national registry and appraisal of available genetic and clinical data. *Diabetes Research and Clinical Practice*, 123, 134–142. <https://doi.org/10.1016/j.diabres.2016.10.017>
- Gonsorčíková, L., Průhová, Š., Cinek, O., Ek, J., Pelikánová, T., Jørgensen, T., ... Lebl, J. (2008). Autosomal inheritance of diabetes in two families characterized by obesity and a novel H241Q mutation in NEUROD1. *Pediatric Diabetes*, 9(4pt2), 367–372. <https://doi.org/10.1111/j.1399-5448.2008.00379.x>
- Horikawa, Y., & Enya, M. (2019). Genetic dissection and clinical features of MODY6 (NEUROD1-MODY). *Current Diabetes Reports*, 19(3), 12. <https://doi.org/10.1007/s11892-019-1130-9>
- Horikawa, Y., Enya, M., Mabe, H., Fukushima, K., Takubo, N., Ohashi, M., ... Takeda, J. (2018). NEUROD1-deficient diabetes (MODY6): Identification of the first cases in Japanese and the clinical features. *Pediatric Diabetes*, 19(2), 236–242. <https://doi.org/10.1111/peidi.12553>
- Kristinsson, S. Y., Talseth, B., Steingrimsen, E., Thorsson, A. V., Helgason, T., Hreidarsson, A. B., ... Arngrimsson, R. (2001). MODY in Iceland is associated with mutations in HNF-1alpha and a novel mutation in NeuroD1. *Diabetologia*, 44(11), 2098–2103. <https://doi.org/10.1007/s001250100016>
- Liu, L., Furuta, H., Minami, A., Zheng, T., Jia, W., Nanjo, K., & Xiang, K. (2007). A novel mutation, Ser159Pro in the NeuroD1/BETA2 gene contributes to the development of diabetes in a Chinese potential MODY family. *Molecular and Cellular Biochemistry*, 303(1–2), 115–120. <https://doi.org/10.1007/s11010-007-9463-0>
- Malecki, M. T., Jhala, U. S., Antonellis, A., Fields, L., Doria, A., Orban, T., ... Krolewski, A. S. (1999). Mutations in NEUROD1 are associated with the development of type 2 diabetes mellitus. *Nature Genetics*, 23(3), 323–328. <https://doi.org/10.1038/15500>
- Naya, F. J., Huang, H.-P., Qiu, Y., Mutoh, H., DeMayo, F. J., Leiter, A. B., & Tsai, M.-J. (1997). Diabetes, defective pancreatic morphogenesis, and abnormal enteroendocrine differentiation in BETA2/NeuroD-deficient mice. *Genes & Development*, 11(18), 2323–2334. <https://doi.org/10.1101/gad.11.18.2323>
- Naya, F. J., Stellrecht, C. M. M., & Tsai, M. J. (1995). Tissue-specific regulation of the insulin gene by a novel basic helix-loop-helix transcription factor. *Genes & Development*, 9(8), 1009–1019. <https://doi.org/10.1101/gad.9.8.1009>
- Qiu, Y., Sharma, A., & Stein, R. (1998). p300 mediates transcriptional stimulation by the basic helix-loop-helix activators of the insulin gene. *Molecular and Cellular Biology*, 18(5), 2957–2964. <https://doi.org/10.1128/MCB.18.5.2957>
- Rubio-Cabezas, O., Minton, J. A. L., Kantor, I., Williams, D., Ellard, S., & Hattersley, A. T. (2010). Homozygous mutations in NEUROD1 are responsible for a novel syndrome of permanent neonatal diabetes and neurological abnormalities. *Diabetes*, 59(9), 2326–2331. <https://doi.org/10.2337/db10-0011>
- Szopa, M., Ludwig-Galezowska, A. H., Radkowski, P., Skupien, J., Machlowska, J., Klupa, T., ... Malecki, M. T. (2016). A family with the Arg103Pro mutation in the NEUROD1 gene detected by next-generation sequencing - Clinical characteristics of mutation carriers. *European Journal of Medical Genetics*, 59(2), 75–79. <https://doi.org/10.1016/j.ejmg.2016.01.002>

How to cite this article: Abreu GDM, Tarantino RM, Cabello PH, et al. The first case of NEUROD1-MODY reported in Latin America. *Mol Genet Genomic Med*. 2019;e989. <https://doi.org/10.1002/mgg3.989>

Capítulo III

“Identification of the First PAX4-MODY Family Reported in Brazil”

Modificações no gene *PAX4* são associadas a formas poligênica e monogênica de diabetes *mellitus*, sendo as formas monogênicas causas raras da doença. Neste próximo capítulo realizamos um levantamento bibliográfico e descrevemos uma variante do tipo sentido trocado no *PAX4* segregando em três gerações de uma família brasileira. As características clínicas e bioquímicas dos familiares estão apresentadas no estudo. Para descartar a possibilidade desta variante não ser a causa do diabetes nesta família, foram realizados estudos de bioinformática como análises de conservação do aminoácido, análise de patogenicidade da variante através de ferramentas *in silico*, além do rastreamento da variante em indivíduos normoglicêmicos. Por fim, as características clínicas do caso-index foram comparadas com dos probandos descritos na literatura.

Publicado na revista: *Diabetes, Metabolic Syndrome and Obesity: Targets and Therapy* 2020; 13:2623–2631.

Identification of the First PAX4-MODY Family Reported in Brazil

This article was published in the following Dove Press journal:
Diabetes, Metabolic Syndrome and Obesity: Targets and Therapy

Gabriella de Medeiros Abreu ^{1,*}
Camila de Almeida Pereira
Dias Soares ^{1,*}
Roberta Magalhães Tarantino ^{2,3}
Ana Carolina Proença da Fonseca ¹
Ritiele Bastos de Souza¹
Maria de Fátima Carvalho Pereira ⁴
Pedro Hernan Cabello ^{1,5}
Melanie Rodacki²
Lenita Zajdenverg ²
Verônica Marques Zembrzski ¹
Mário Campos Junior ¹

¹Human Genetics Laboratory, Oswaldo Cruz Institute, Oswaldo Cruz Foundation, Rio de Janeiro, Brazil;

²Diabetes and Nutrology Section, Internal Medicine Department, Federal University of Rio de Janeiro, Rio de Janeiro, Brazil; ³Ambulatory of Diabetes, State Institute for Diabetes and Endocrinology Luiz Capriglione, Rio de Janeiro, Brazil; ⁴Clinical Pathology Department, Federal University of Rio de Janeiro, Rio de Janeiro, Brazil;

⁵Laboratory of Genetics, School of Health Science, University of Grande Rio, Rio de Janeiro, Brazil

*These authors contributed equally to this work

Correspondence: Mário Campos Junior
Human Genetics Laboratory, Oswaldo Cruz Institute, Oswaldo Cruz Foundation, Pavilhão Leônidas Deane, Sala 615, Avenida Brasil 4365, Rio de Janeiro 21040-360, RJ, Brazil
Tel +55 21 3865 8192
Email mario.junior@ioc.fiocruz.br

submit your manuscript | www.dovepress.com
Dovepress    
<https://doi.org/10.2147/DMSO.S236858>

Purpose: The aim of this study was to sequence the coding region of the *PAX4* gene in a Brazilian cohort with clinical manifestations of monogenic diabetes.

Patients and Methods: This study included 31 patients with autosomal dominant history of diabetes, age at diagnosis ≤ 40 years, BMI < 30 kg/m², and no mutations in *GCK* or *HNFI1A*, *HNFA4*, and *HNFB1B*. Screening of the *PAX4* coding region was performed by Sanger sequencing. In silico algorithms were used to assess the potential impact of amino acid substitutions on protein structure and function. Additionally, *PAX4*-MODY family members and 158 control subjects without diabetes were analyzed for the identified mutation.

Results: The molecular analysis of *PAX4* has detected one missense mutation, p.Arg164Gln (c.491G>A), segregating with diabetes in a large Brazilian family. The mutation was absent among the control group. The index case is a woman diagnosed at 32 years of age with polyneuropathy and treated with insulin. She did not present diabetic renal disease or retinopathy. Family members with the *PAX4* p.Arg164Gln mutation have a heterogeneous clinical manifestation and treatment response, with age at diagnosis ranging from 24 years to 50 years.

Conclusion: To the best of our knowledge, this is the first study to report a *PAX4*-MODY family in Brazil. The age of *PAX4*-MODY diagnosis in the Brazilian family seems to be higher than the classical criteria for MODY. Our results reinforce the importance of screening large monogenic diabetes families for the understanding of the clinical manifestations of rare forms of diabetes for the specific and personalized treatment.

Keywords: diabetes mellitus, monogenic diabetes, MODY, *PAX4*, mutation

Introduction

In the past years, mutations in genes that disrupt the secretion and signaling of insulin have been recognized as causative factors for monogenic forms of diabetes mellitus (DM). Among these genes, there are critical transcription factors, such as *HNFA4*,¹ *HNFI1A*,² *HNFB1B*,³ *PDX1*,⁴ *NEUROD1*,⁵ *KLF11*,⁶ and *PAX4*.⁷ The *Paired Box Gene 4* (*PAX4*; OMIM*167413), also known as MODY9 gene, encodes a transcription factor that plays an important role in the development of β -cells and δ -cells. *PAX4* acts in the differentiation of β -cells and δ -cells precursors in the early pancreas and later maintaining β -cells in differentiated state.⁸ In vivo experiments demonstrated that newborn mice that are knockout for both *Pax4* alleles exhibit growth retardation and dehydration, dying 3 days after birth.⁸ To date, several variants in the *PAX4* gene have been associated with a number of DM types, including type 1 DM (T1D),⁹ type 2 DM (T2D),¹⁰ Ketosis-Prone Diabetes

Diabetes, Metabolic Syndrome and Obesity: Targets and Therapy 2020:13 2623–2631

2623



© 2020 Abreu et al. This work is published and licensed by Dove Medical Press Limited. The full terms of this license are available at <https://www.dovepress.com/terms.php> and incorporate the Creative Commons Attribution – Non Commercial (unported, v3.0) License (<http://creativecommons.org/licenses/by-nc/3.0/>). By accessing the work you hereby accept the Terms. Non-commercial uses of the work are permitted without any further permission from Dove Medical Press Limited, provided the work is properly attributed. For permission for commercial use of this work, please see paragraphs 4.2 and 5 of our Terms (<https://www.dovepress.com/terms.php>).

(KPD),¹¹ as well as monogenic diabetes.⁷ Mutations associated with monogenic diabetes were first identified in two patients of Thai origin, who did not present mutations in the other known MODY genes.⁷ More than one decade after this initial report, the number of studies supporting the involvement of *PAX4* mutations in monogenic diabetes remains limited to a few cases, and restricted to Asian populations.^{7,12,15} Due to its rarity, the clinical characteristics of *PAX4*-MODY remain unclear, compromising its diagnosis. In this context, the identification of new cases will be helpful to better understand the *PAX4*-MODY phenotype. This study aimed to screen the coding region of *PAX4* gene in a sample of Brazilian patients with a clinical suspicion of monogenic diabetes. To the best of our knowledge, this is the first study to describe a *PAX4* mutation in a large Brazilian family with autosomal dominant diabetes.

Patients and Methods

Subjects

In this cross-sectional observational study, 31 unrelated patients with DM (13 males and 18 females; average age at diagnosis: 19.7±10.9 years) were recruited from the Clementino Fraga Filho University Hospital and from the State Institute for Diabetes and Endocrinology Luiz Capriglione, Rio de Janeiro, Brazil. In this study, the inclusion criteria were as follows: 1) age at onset equal to or less than 40 years old; 2) a positive family history of diabetes in at least two generations; and 3) negative β -cells anti-GAD (Glutamic Acid Decarboxylase) and anti-IA-2 (Islet Antigen-2) autoantibodies. We excluded patients with T1D, obesity (Body Mass Index [BMI] ≥ 30 kg/m² or ≥ 95 th percentile for age at diagnosis), history of diabetic ketoacidosis at diabetes onset, clinical signs of insulin resistance, and the presence of secondary causes of diabetes. Clinical information was obtained through a review of the medical chart. All patients were previously screened for *GCK* or *HNF1A* (based on the clinical phenotype),¹⁶ *HNF4A* and *HNF1B* mutations and did not show mutations. Additionally, family members were screened for the novel variant, as well as 158 healthy controls (59 males and 99 females; average age: 32.03 ± 8.41 years; BMI average: 22.48±1.40 kg/m²). The control group inclusion criteria were as follows: 1) fasting plasma glucose (FPG) <100 mg/dL and glycated hemoglobin (HbA1c) <5.7%; 2) BMI ≤ 24.9 kg/m²; and 3) Individuals without a family history of diabetes. The Ethics and

Research Committee of the Clementino Fraga Filho University Hospital (CAAE n° 04232512.4.0000.5257) and of the State Institute for Diabetes and Endocrinology Luiz Capriglione (CAAE n° 04232512) approved this study protocol. All participants were informed about the aim of this study and provided verbal and written consent.

Molecular Genetics

Genomic DNA from the probands and nondiabetic controls were isolated from peripheral blood leukocytes using the QIAamp DNA Blood Mini Kit (Qiagen, Hilden, Germany). The proband's family had their genomic DNA extracted from buccal epithelial cells.¹⁷ Screening of the entire coding region and exon-intron boundaries of the *PAX4* gene was done (Supplemental Table S1). PCR products were purified by ExoSAP-IT Reagent (Applied Biosystems, Vilnius, Lithuania). Sanger sequencing was performed using the Big Dye Terminator Kit v3.1 (Applied Biosystems, Austin, TX, USA), conducted on an ABI 3130 Automatic Genetic Analyzer (Applied Biosystems).

Bioinformatic Analysis

The *PAX4* variants identified were checked against PubMed, Clinvar, dbSNP (<https://www.ncbi.nlm.nih.gov/>), Human Genome Mutation Database (HGMD) (<http://www.hgmd.cf.ac.uk/ac/>), ExAC Browser (<http://exac.broadinstitute.org/>), 1000 Genomes project database (<http://www.internationalgenome.org/>), and Online Archive of Brazilian Mutations (ABraOM; <http://abraom.ib.usp.br/index.php>),¹⁸ in order to investigate their previous occurrence in these public databases. To assess the potential impact of the missense mutations identified, in silico pathogenicity prediction algorithms were used, including SIFT,¹⁹ PolyPhen-2,²⁰ PROVEAN,²¹ Revel,²² WS-SNPs&GO,²³ MutPred,²⁴ SNAP,²⁵ Fathmm,²⁶ M-CAP,²⁷ CADD,²⁸ Mutation assessor,²⁹ Align-GVGD,³⁰ PANTHER-PSEP,³¹ and Mutation Taster.³² The Ensembl reference transcript ENST00000341640.2 of *PAX4* gene (Genome release GRCh37.p13) was used as reference (<https://www.ensembl.org/index.html>).

Results

In this study, we screened the entire coding region of the *PAX4* gene in 31 unrelated probands from Brazil. The participants have clinical characteristics of monogenic diabetes. Our results showed a missense mutation p.Arg164Gln (c.491G>A) segregating with DM in a large Brazilian family. This variant was absent among the 158 normoglycemic controls analyzed and was not found in the ABraOM database. We

also found the variant p.Arg133Trp (c.397C>T) in heterozygous state in three patients (9.67%) and in one homozygous patient (3.22%), and the common missense p.His321Pro (c.962A>C) variant in 28 probands (C allele frequency: 0.677). The synonymous p.Gln173Gln (c.519A>G) and p.Gly150Gly (c.450C>T) variants were found in five patients (16.12%) and in one patient (3.22%), respectively.

The arginine residue in position 164 of the PAX4 homeodomain is evolutionary conserved among several species (Figure 1). The change of the arginine amino acid to glutamine in the 164 position was predicted to be harmful by all 15 algorithms (Table 1). The arginine is an amino acid charged positively while glutamine belongs to uncharged polar side groups. This mutation was registered

in dbSNP under the access number rs587780414; it was found with allele frequency of 0.00004119 in ExAC. However, we did not find any previously association of this mutation to DM (Table 2).

We identified the *PAX4* p.Arg164Gln in the heterozygous state in a normal weight woman (BMI: 24.8 kg/m²; Current age: 45 years). She was diagnosed with diabetes during her second pregnancy at the age of 32 years (BMI at diagnosis: 21.68 kg/m²). She reported polyneuropathy and did not present diabetic renal disease or retinopathy until that moment. The patient was treated with insulin therapy since the diagnosis of DM. The family pedigree is shown in Figure 2 and clinical features are summarized in Table 3.

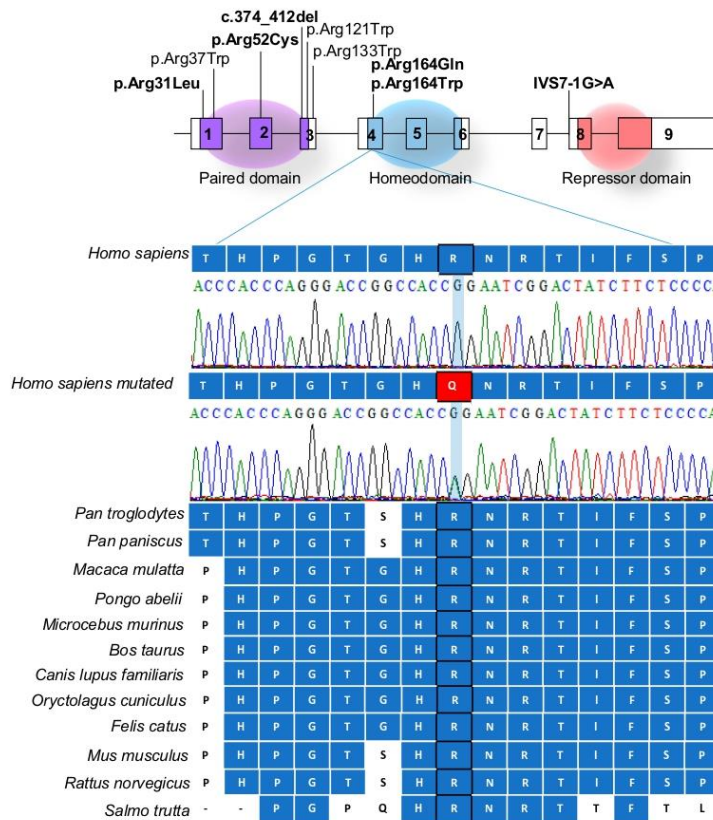

Figure 1 Diagrammatic representation of *PAX4* gene and protein domains. Pathogenic mutations described associated to diabetes mellitus are pointed in the figure and *PAX4-MODY* are show in bold. Electropherograms of *PAX4* exon 4 wild type and p.Arg164Gln (c.491G>A) in the patient DM35. Alignment by Clustal W (1.81) of *PAX4* gene across species are presented (below).

Table 1 In silico Prediction of Missense Mutations Identified in *PAX4* Gene

Prediction Tool	Output	PAX4 – p.Arg164Gln		PAX4 – p.Arg133Trp	
		Score	Prediction	Score	Prediction
SIFT	<0.05 damaging/≥0.05 tolerated (score range: 0–1)	0.01	Damaging	0.1	Tolerated
PolyPhen-2_HVAR	Probably damaging, possibly damaging or benign (score range: 0 [benign] to 1 [damaging])	0.997	Probably damaging	0.123	Benign
PolyPhen-2_HDIV	Probably damaging, possibly damaging, or benign (score range: 0 [benign] to 1 [damaging])	1.000	Probably damaging	0.829	Possibly damaging
PROVEAN	<-2.5 deleterious/>-2.5 neutral (default score threshold: -2.5)	-3.04	Deleterious	1.19	Neutral
Revel	>0.50 likely disease causing/<0.50 likely benign (score range: 0 to 1)	0.871	Likely disease causing	0.318	Likely benign
WS-SNPs&GO	>0.5 disease-associated (score range: 0 to 1)	0.642	Disease	0.160	Neutral
MutPred2	General pathogenicity score: ≥0.50 (score range: 0 to 1)	0.501	Possibly pathogenic	0.175	Benign
SNAP	≥1 effect (score range: -100 to 100)	74	Effect	71	Effect
Fathmm	Pathogenicity threshold: <0	-4.12	Damaging	-3.40	Damaging
M-CAP	Pathogenicity threshold: >0.025	0.337	Possibly pathogenic	*	*
CADD	>30 likely deleterious/<30 likely benign	31	Likely deleterious	22	Likely benign
Mutation Assessor	Score cutoff: 0.8 neutral and low impact/1.9 low impact and medium impact/3.5 medium impact and high impact	3.615	High	0	Neutral
Align-GVGD	C0 most likely neutral to C65 most likely deleterious (classifiers: C0 to C65)	C35	Likely deleterious	C65	Likely deleterious
PANTHER-PSEP	Length of time: >450 my probably damaging/450 my>time>200 my possibly damaging/<200 my probably benign	1038	Probably damaging	30	Probably benign
Mutation Taster	A. Disease causing; probably deleterious/D. disease causing automatic; deleterious/N. polymorphism; probably harmless/P. polymorphism automatic; harmless	A	Disease causing	N	Polymorphism
Total prediction tools = 15		15 = predicted to be harmful		4 = predicted to be harmful	

Notes: *M-CAP scores not available for some alleles at Ch7:127,254,551 chromosome position. SIFT: <https://sift.bii.a-star.edu.sg/>, Polyphen: <http://genetics.bwh.harvard.edu/pph2/index.shtml>, PROVEAN: <http://provean.jcvi.org/>, Revel: <https://sites.google.com/site/revelgenomics/downloads>, WS-SNP&GO: <http://snps.biofold.org/snps-and-go/>, MutPred2: <http://mutdb.org/mutpred>, SNAP: <http://www.rostlab.org/services/SNAP>, Fathmm: <http://fathmm.biocompute.org.uk/index.html>, M-CAP: <http://bejerano.stanford.edu/mcap/>, CADD: <https://cadd.gs.washington.edu/sn>, MutationAssessor: <http://mutationassessor.org/r3/>, Align GVGD: http://agvgd.hci.utah.edu/agvgd_input.php, PANTHER-PSEP: <http://www.pantherdb.org/tools/cnpScore.do>, MutationTaster: <http://www.mutationtaster.org/>.

Abbreviation: my, millions of years.

The index-case's mother (II-4) was diagnosed with DM at 45 years of age and died at 73 years with chronic kidney disease. The patient also reported three deceased uncles (individuals II-2, II-3, and II-5), three deceased aunts (individuals II-1, II-6, and II-7), and a cousin (individual III-9) with diabetes and four sisters with hyperglycemia (individuals III-2, III-3, III-4, and III-6). Thirteen family members were available for genetic testing and eight of them were found to be carrying the p.Arg164Gln, of which four exhibited hyperglycemia.

The proband's older sister (individual III-2) is an overweight woman of 56 years old (BMI= 29.48 kg/m²; FPG=

128 mg/dl; HbA1c= 11.3%) diagnosed with DM at 38 years. She carried the mutation p.Arg164Gln in a heterozygous state. She has been on oral antidiabetic agents (OAD) treatment for 8 years (Metformin 1500 mg/day; Gliclazide 60 mg/day) and has hypertension. The carrier proband's sister (individual III-3) is 49 years, non-obese (BMI= 23.61 kg/m²), and was diagnosed at 49 years with FPG of 104 mg/dL, glucose 2 hours post dextrose of 142 mg/dL, and HbA1c 6%. She is on Metformin 1000 mg/day. Like her, the carrier sister (individual III-4) was diagnosed with impaired glucose tolerance (IGT) at the age of 50 years and has been managed with nutritional

Table 2 Characterization of Mutations in *PAX4* Gene Associated to Diabetes Mellitus

Exon or Intron	Mutated Protein	Mutated DNA	Consequence	Access Number	Clinvar	Domain	Functional Studies	Ref.
1	p.Arg31Leu	c.92G>A	Missense	rs115887120	Likely-benign	PD	na	[14]
1	p.Arg37Trp	c.109C>T	Missense	rs35155575	Uncertain-significance, risk-factor	PD	Decreased transcriptional repress promoter function and decreased binding activity	[11,33]
2	p.Arg52Cys	c.154C>T	Missense	rs770923465	na	PD	na	[15]
3	na	c.374_412del	Sequence alteration	rs1325888696	na	PD	Loss of transcriptional repressor function	[12]
3	p.Arg121Trp	c.361C>T	Missense	rs14202595	Pathogenic	PD	Loss of transcriptional repressor function	[10]
3	p.Arg133Trp	c.397C>T	Missense	rs2233578	Benign/Likely benign, risk factor	Between PD and HD	Decreased transcriptional repress promoter function	[11]
4	p.Arg164Trp	c.490C>T	Missense	rs121917718	Pathogenic	HD	Decreased transcriptional repress promoter function	[7]
4	p.Arg164Gln	c.491G>A	Missense	rs587780414	na	HD	na	#
IVS7	IVS7-1G>A (p.Gln250del)	c.748-1G>A	Splice acceptor variant	rs371715169	Pathogenic	Between HD and RD	Decreased transcriptional repress promoter function	[7,13]

Note: #Mutation identified in this study.

Abbreviations: Ref, reference; PD, paired domain; HD, homeodomain; RD, repressor domain; na, not available.

therapy (FPG= 93 mg/dL; HbA1c= 6.1%). The sister with DM (individual III-6) did not present the mutation. She received the diagnosis in her second gestation at the age of 25 years old. She has been treated with fast-acting insulin analog. The family reported that the proband's older brother (individual III-1) had schizophrenia and died at 48 years old due to a heart attack, and DM was not reported.

The proband's cousin with DM (individual III-9) also presented the mutation tested (FPG=169 mg/dL; HbA1c= 7.4%) and received the diagnosis in her second gestation at 24 years. She has diabetic retinopathy. Her mother with DM (individual II-7) was diagnosed at 36 years in her second gestation and had been on dialysis before dying.

In the younger examined generation, all eight individuals do not have DM (individuals IV-3, IV-5, IV-6, IV-9, IV-12, IV-13, IV-14, and IV-15). Four of them presented the genetic variant, including three proband's nieces (individuals IV-3, IV-5, and IV-6), of 27 years, 35 years, and 29 years old, respectively, and the proband's younger daughter (individual IV-13), of 14 years old.

Discussion

Variants in the *PAX4* gene have been associated to the risk of non-monogenic types of DM in the past years. However, a few mutations in this gene have also been described as the cause of monogenic diabetes (Table 4), and, to the best of our knowledge, this is the first monogenic diabetes case (*PAX4*-MODY) reported in a Brazilian family.

Shimajiri et al¹⁰ described the p.Arg121Trp mutation in seven Japanese patients with T2D and absent among 161 controls (Table 4). One of these patients, a woman diagnosed at the age of 29 years, carried this variant in the homozygous state. The variant p.Arg121Trp segregated from her heterozygous parents, who were cousins, to the patient and to her heterozygous sister. Severe diabetes was presented only in the homozygous proband. In our sample, we identified the p.Arg133Trp in three patients in heterozygosis and in one patient in homozygosis. This variant was described as benign/risk factor by ClinVar and it was predicted to be benign by the majority of the in silico tools analyzed (Table 1). Mauvais-Jarvis et al¹¹ previously reported an

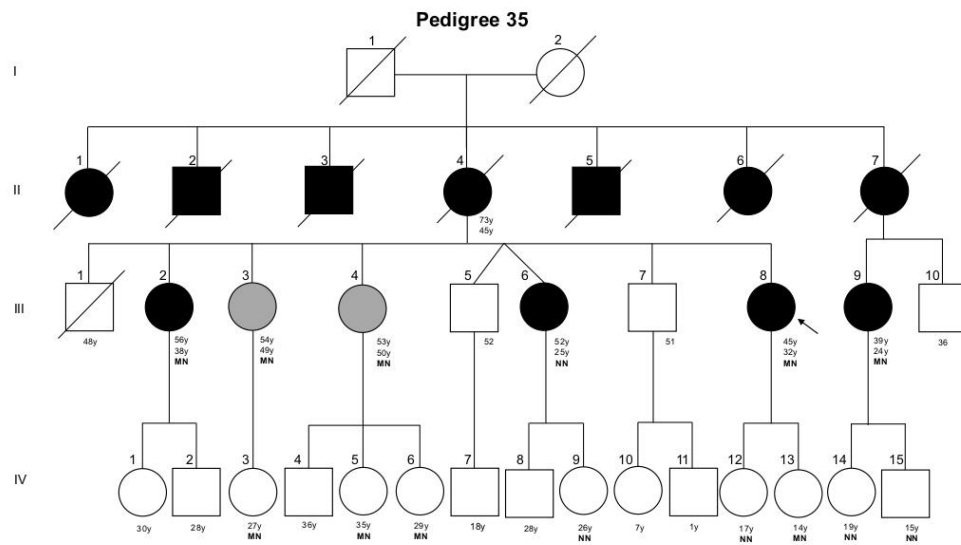

Figure 2 Pedigree of family 35. Filled black symbols, grey symbols, and empty symbols represent diabetic patients, impaired glucose tolerance individuals, and healthy individuals, respectively. The present age of the individuals are shown below the symbols in years (y), followed by age of diagnosis in years, and genotype. Genotypes are expressed by normal allele (N) and mutated allele (M); An arrow indicates the index case.

association of the p.Arg133Trp in homozygous state to ketosis-prone diabetes (KPD), a rare form of T2D. In vivo and in vitro studies showed that this variant alters the protein function (Table 2). They also observed the p.Arg37Trp mutation in a patient from Cameroon. This variant was later described co-segregating in a heterozygous form with *BLK* p.Phe112Ser (c.335C>T) in a Nigerian woman with KPD.³³ Further case-control studies should be carried out to evaluate the association of these variants with different forms of diabetes.

Plengvidhya et al⁷ described in Thai families the first association of mutations in *PAX4* to MODY diabetes. They observed one missense mutation, p.Arg164Trp, in the *PAX4* homeodomain in a female patient diagnosed at the age of 20 years and treated with OAD. In vitro analysis showed that p.Arg164Trp decreased *PAX4* repression activity. They also found an intronic variant (IVS7-1G>A) in one woman with DM diagnosed at 44 years of age⁷ and after, in her daughter who was diagnosed at 30 years of age with gestational DM and required insulin treatment.¹³ Another four non-tested

Table 3 Clinical Features and Laboratory Parameters of the Family 35 Members

Patient	III-2	III-3	III-4	III-6	III-8*	III-9	IV-3	IV-5	IV-6	IV-9	IV-12	IV-13	IV-14	IV-15
Gender	Female	Female	Female	Female	Female	Female	Female	Female	Female	Female	Female	Female	Female	Male
BMI (kg/m ²)	29.48	23.61	24.93	27.97	24.8	30.62	25.73	25.55	na	20.38	na	na	23.23	28.84
Current age (years)	56	54	53	52	45	39	27	35	29	26	17	14	19	15
AAD (years)	38	49	50	25	32	24	-	-	-	-	-	-	-	-
FPG (mg/dl)	128	101	93	256	na	169	84	80	na	80	na	na	68	86
HbA1c (%)	11.3	6	6.1	9.6	na	7.4	5.3	5.5	na	5.1	na	na	5.4	5.4
Treatment	OAD	OAD	Diet	Insulin	Insulin	Insulin	-	-	-	-	-	-	-	-
Genotype	MN	MN	MN	NN	MN	MN	MN	MN	MN	NN	NN	MN	NN	NN

Note: *Proband.

Abbreviations: BMI, body mass index (at admission); AAD, age at diagnosis; FPG, fasting plasma glucose; HbA1c, glycated hemoglobin; OAD, oral antidiabetic agent; Genotypes are expressed by normal allele (N) and mutated allele (M); na, not available; -, not applicable.

Table 4 Clinical Characteristics of Patients with DM with Mutations in *PAX4* Gene

P	Sex	AAD	BMI	HbA1c	Treat.	Mutation	Segregation Study DM/NDM	N° P (He; Ho)	N° C (He; Ho)	Ethnic Group	DM Type	Ref.
1	F	43	29.4	7	Diet	p.Arg121Trp	na	200 (6:1)	161 (0:0)	Japanese	T2 DM	[10]
2	M	49	26.7	6.1	Diet	p.Arg121Trp	na					
3	M	49	17.8	8.1	OAD	p.Arg121Trp	na					
4	F	47	32.4	6.8	OAD	p.Arg121Trp	na					
5	M	32	22	8.8	OAD	p.Arg121Trp	na					
6	F	25	21.8	8.2	Ins	p.Arg121Trp	na					
7	F	29	22.2	7.3	Ins	p.Arg121Trp*	1MN/2MN					
8	M	47	26.5	13.8	OAD	p.Arg133Trp*	na	101 (27:4)	355 (69:0)	West African	KPD	[11]
9	M	22	16.2	12.2	OAD	p.Arg133Trp*	na					
10	M	38	25.4	14.1	OAD	p.Arg133Trp*	na					
11	M	20	21.6	12.5	OAD	p.Arg133Trp*	na					
12	M	39	28.7	11.6	Ins	p.Arg37Trp	na	101 (1:0)	255 (0:0)	West African	KPD	[11]
13	F	20	na	na	OAD	p.Arg164Trp	2 NN, 3 MN/.	46 (1:0)	344 (0:0)	Thai	MODY	[7]
14	F	44	na	na	na	IVS7-1G>A	1 MN/ INN	46 (1:0)	344 (0:0)	Thai	MODY	[7,13]
15	M	15	18.2	14.5	Ins	c.374_412del	1 MN/.	1 (1:0)	150 (0:0)	Japanese	MODY	[12]
16	M	14	23	na	Ins, OAD	p.Arg31Leu	na	56 (1:0)	60 (0:0)	Indian	MODY	[14]
17	F	38	28.4	14	Ins	p.Arg37Trp	na	1 (1:0)	0	African	KPD	[33]
18	M	35	28.1	9.2	OAD	p.Arg52Cys	na	84 (1:0)	0	Malay	MODY	[15]
19	F	32	21.6	na	Ins	p.Arg164Gln	1 NN, 5MN/4 NN, 4 MN	31 (1:0)	158 (0:0)	Brazilian	MODY	#

Notes: *Mutation in homozygous state; #Mutation identified in this study; DM includes patients with impaired glucose tolerance.

Abbreviations: P, patient; AAD, age at diagnosis (in years); BMI, body mass index (kg/m²); HbA1c, glycated hemoglobin (%); Treat., treatment; DM, diabetes mellitus; NDM, non-diabetic subjects; N°, Number; He, mutation in heterozygous; Ho, mutation in homozygous; C, controls; Ref, reference; F, female; M, male; OAD, oral antidiabetic agents; Ins, insulin; na, not available; NM, genotype mutated in heterozygous state; NN, genotype homozygous normal; T2 DM, type 2 diabetes mellitus; KPD, ketosis-prone diabetes; MODY, maturity-onset diabetes of the young.

members from this family showed several complications, such as diabetic renal disease and retinopathy, and three of them died of end-stage renal failure.^{7,13} Similarly, two non-tested members from the Brazilian family reported in our study had diabetic end-stage renal disease (Figure 2; individuals II-4 and II-7); and one mutated patient (Figure 2; individual III-9) had diabetic retinopathy 15 years after disease onset. The guanine to adenine change in the last nucleotide of intron 7 (IVS7-1G>A) disrupts mRNA splicing and results in an in-frame deletion p.Gln250del (exon 8). Similar to p.Arg164Trp, the *PAX4* p.Gln250del have its repressor activity of glucagon and insulin promoter impaired. Studies in vitro showed that this mutation increased susceptibility to apoptosis within high glucose condition.¹³

Jo et al¹² found a frameshift deletion (c.374_412del) in a 15-year-old Japanese proband on insulin treatment. His father was diagnosed at 30 years old with T2D and had his glucose controlled only by nutritional therapy. This deletion leads to the loss of *PAX4* homeodomain, decreasing its repression activity. Another two missense mutations, p.Arg31Leu¹⁴ and p.Arg52Cys,¹⁵ were found in an Indian and in a Malay patient, respectively. Both exhibited clinical hallmarks of monogenic diabetes.

Here, we report a rare missense mutation in the *PAX4* gene, p.Arg164Gln, in a large Brazilian family. Interestingly, this mutation is located in the same residue of the first mutation described associated to *PAX4*-MODY in a Thai family by Plengvidhya et al.⁷ The age at diagnosis of the hyperglycemic

members from the family described here ranged from 24 years to 50 years. Whereas in the Thai family described, members were treated with OAD or diet, in the Brazilian family the treatment was variable (Diet: 1; OAD: 2; Insulin: 3). In addition, two proband's sisters presented impaired glucose tolerance; the same was observed in the proband's brother from a Thai family. It seems that phenotypes can vary between affected members from the same family, from severe to mild clinical presentations, as also observed by other studies of PAX4-MODY families,^{7,12} imposing a challenge for establishing a clinical pattern for PAX4-MODY. The age at diagnosis observed in the patients with the p.Arg164Gln mutation from the Brazilian family was remarkably high. Among the five mutated patients from the third generation, three presented diabetes symptoms after 35 years of age; the age at diagnosis was higher than that expected for MODY most common forms. This late development could explain the absence of DM in the younger carrier individuals of this family. Unexpectedly, one sister with DM (Figure 2; individual III-6) did not show the mutation p.Arg164Gln. She reported weight gain at the time of diagnosis, which could represent a phenocopy of diabetes. This is similar to the two sisters described in the Thai family, who presented impaired glucose tolerance and did not carry the mutation.⁷

Our study has some limitations; the proband's biochemical exams were not available and she abandoned treatment and medical care. We did not have access to the two brothers (Figure 2; individuals III-5 and III-7) and the cousin (Figure 2; individual III-10) without DM, which could reinforce the role of PAX4 p.Arg164Gln as the cause of DM in this family.

Until now, PAX4-MODY had been described only in families with Asian origins. To our knowledge, this is the first study to report a PAX4-MODY in a family in South America. Functional studies are needed to better understand the role of PAX4 p.Arg164Gln mutation in the cause of monogenic diabetes and its contribution to the clinical profile of PAX4-MODY patients.

Acknowledgments

The authors are grateful to the patients and their families and to the DNA Sequencing Platform from Oswaldo Cruz Institute (RPT01A). This work was supported by the National Council for Scientific and Technological Development (CNPq), Coordination for the Improvement of Higher Education Personnel (CAPES), Carlos Chagas Filho Rio de Janeiro State Research Foundation (FAPERJ), and Oswaldo Cruz Institute (IOC).

Disclosure

The authors declare no conflict of interest.

References

1. Yamagata K, Furuta H, Oda N, et al. Mutations in the hepatocyte nuclear factor-4 α gene in maturity-onset diabetes of the young (MODY1). *Nature*. 1996;384(6608):458–460. doi:10.1038/384458a0
2. Yamagata K, Oda N, Kaisaki PJ, et al. Mutations in the hepatocyte nuclear factor-1 α gene in maturity-onset diabetes of the young (MODY3). *Nature*. 1996;384(6608):455–458. doi:10.1038/384455a0
3. Horikawa Y, Iwasaki N, Hara M, et al. Mutation in hepatocyte nuclear factor-1 β gene (TCF2) associated with MODY. *Nat Genet*. 1997;17(4):384–385. doi:10.1038/ng1297-384
4. Stoffers DA, Ferrer J, Clarke WL, Haneber JF. Early-onset type-II diabetes mellitus (MODY4) linked to IPF1. *Nat Genet*. 1997;17:138–139. doi:10.1038/ng0797-270
5. Malecki MT, Jhala US, Antonellis A, et al. Mutations in NEUROD1 are associated with the development of type 2 diabetes mellitus. *Nat Genet*. 1999;23(3):323–328. doi:10.1038/15500
6. Neve B, Fernandez-Zapico ME, Ashkenazi-Katalan V, et al. From the cover: role of transcription factor KLF11 and its diabetes-associated gene variants in pancreatic beta cell function. *Proc Natl Acad Sci*. 2005;102(13):4807–4812. doi:10.1073/pnas.0409177102
7. Plengvidhya N, Kooptiwut S, Songtawe N, et al. PAX4 mutations in thais with maturity onset diabetes of the young. *J Clin Endocrinol Metab*. 2007;92(7):2821–2826. doi:10.1210/jc.2006-1927
8. Sosa-Pineda B, Chowdhury K, Torres M, Oliver G, Gruss P. The Pax4 gene is essential for differentiation of insulin-producing β cells in the mammalian pancreas. *Nature*. 1997;386(6623):399–402. doi:10.1038/386399a0
9. Biason-Lauber A, Boehm B, Lang-Muritano M, et al. Association of childhood type 1 diabetes mellitus with a variant of PAX4: possible link to beta cell regenerative capacity. *Diabetologia*. 2005;48(5):900–905. doi:10.1007/s00125-005-1723-5
10. Shimajiri Y, Sanke T, Furuta H, et al. A missense mutation of Pax4 gene (R121W) is associated with type 2 diabetes in Japanese. *Diabetes*. 2001;50(12):2864–2869. doi:10.2337/diabetes.50.12.2864
11. Mauvais-Jarvis F, Smith SB, Le May C, et al. PAX4 gene variations predispose to ketosis-prone diabetes. *Hum Mol Genet*. 2004;13(24):3151–3159. doi:10.1093/hmg/ddh341
12. Jo W, Endo M, Ishizu K, Nakamura A, Tajima T. A novel PAX4 mutation in a Japanese patient with maturity-onset diabetes of the young. *Tohoku J Exp Med*. 2011;223(2):113–118. doi:10.1620/tjem.223.113
13. Sujitjoo J, Kooptiwut S, Chongjaroen N, Tangjittipokin W, Plengvidhya N, Yenchitsomanus PT. Aberrant mRNA splicing of paired box 4 (PAX4) IVS7-IG>A mutation causing maturity-onset diabetes of the young, type 9. *Acta Diabetol*. 2016;53(2):205–216. doi:10.1007/s00592-015-0760-x
14. Chapla A, Mruthyunjaya MD, Asha HS, et al. Maturity onset diabetes of the young in India - a distinctive mutation pattern identified through targeted next-generation sequencing. *Clin Endocrinol (Oxf)*. 2015;82(4):533–542. doi:10.1111/cen.12541
15. Ang SF, Lim SC, Tan CS, et al. A preliminary study to evaluate the strategy of combining clinical criteria and next generation sequencing (NGS) for the identification of monogenic diabetes among multi-ethnic Asians. *Diabetes Res Clin Pract*. 2016;119:13–22. doi:10.1016/j.diabres.2016.06.008
16. Tarantino RM, Abreu GDM, Fonseca A, et al. MODY probability calculator for GCK and HNF1A screening in a multiethnic background population. *Arch Endocrinol Metab*. 2019;1(8):1–7. doi:10.20945/2359-399700000173

17. Aidar M, Line SRP. A simple and cost-effective protocol for DNA isolation from buccal epithelial cells. *Braz Dent J*. 2007;18(2):148–152. doi:10.1590/S0103-64402007000200012
18. Naslavsky MS, Yamamoto GL, de Almeida TF, et al. Exomic variants of an elderly cohort of Brazilians in the ABraOM database. *Hum Mutat*. 2017;38(7):751–763. doi:10.1002/humu.23220
19. Sim N-L, Kumar P, Hu J, Henikoff S, Schneider G, Ng PC. SIFT web server: predicting effects of amino acid substitutions on proteins. *Nucleic Acids Res*. 2012;40(W1):W452–W457. doi:10.1093/nar/gks539
20. Adzhubei IA, Schmidt S, Peshkin L, et al. A method and server for predicting damaging missense mutations. *Nat Methods*. 2010;7(4):248–249. doi:10.1038/nmeth0410-248
21. Choi Y, Chan AP. PROVEAN web server: a tool to predict the functional effect of amino acid substitutions and indels. *Bioinformatics*. 2015;31(16):2745–2747. doi:10.1093/bioinformatics/btv195
22. Ioannidis NM, Rothstein JH, Pejaver V, et al. REVEL: an ensemble method for predicting the pathogenicity of rare missense variants. *Am J Hum Genet*. 2016;99(4):877–885. doi:10.1016/j.ajhg.2016.08.016
23. Capriotti E, Calabrese R, Fariselli P, Martelli P, Altman RB, Casadio R. WS-SNPs&GO: a web server for predicting the deleterious effect of human protein variants using functional annotation. *BMC Genomics*. 2013;14(Suppl 3):S6. doi:10.1186/1471-2164-14-S3-S6
24. Pejaver V, Urresti J, Lugo-Martinez J, et al. MutPred2: inferring the molecular and phenotypic impact of amino acid variants. *bioRxiv*. 2017:134981. doi:10.1101/134981
25. Bromberg Y, Rost B. SNAP: predict effect of non-synonymous polymorphisms on function. *Nucleic Acids Res*. 2007;35(11):3823–3835. doi:10.1093/nar/gkm238
26. Shihab HA, Gough J, Cooper DN, et al. Predicting the functional, molecular, and phenotypic consequences of amino acid substitutions using hidden markov models. *Hum Mutat*. 2013;34(1):57–65. doi:10.1002/humu.22225
27. Jagadeesh KA, Wenger AM, Berger MJ, et al. M-CAP eliminates a majority of variants of uncertain significance in clinical exomes at high sensitivity. *Nat Genet*. 2016;48(12):1581–1586. doi:10.1038/ng.3703
28. Rentzsch P, Witten D, Cooper GM, Shendure J, Kircher M. CADD: predicting the deleteriousness of variants throughout the human genome. *Nucleic Acids Res*. 2019;47(D1):D886–D894. doi:10.1093/nar/gky1016
29. Reva B, Antipin Y, Sander C. Predicting the functional impact of protein mutations: application to cancer genomics. *Nucleic Acids Res*. 2011;39(17):e118. doi:10.1093/nar/gkr407
30. Tavtigian SV, Byrnes GB, Goldgar DE, Thomas A. Classification of rare missense substitutions, using risk surfaces, with genetic- and molecular-epidemiology applications. *Hum Mutat*. 2008;29(11):1342–1354. doi:10.1002/humu.20896
31. Tang H, Thomas PD. PANTHER-PSEP: predicting disease-causing genetic variants using position-specific evolutionary preservation. *Bioinformatics*. 2016;32(14):2230–2232. doi:10.1093/bioinformatics/btw222
32. Schwarz JM, Cooper DN, Schuelke M, Seelow D. MutationTaster2: mutation prediction for the deep-sequencing age. *Nat Methods*. 2014;11(4):361–362. doi:10.1038/nmeth.2890
33. Schmidt W, Lankers H. Co-inheritance of PAX4 and BLK mutations (MODY 7 and 9) in a 38 year old African Patient with Ketosis-Prone Diabetes. Presented at European Congress of Endocrinology ECE Munich, DEU. *Endocrine abstract*. 2016;41:EP401. doi:10.1530/endoabs.41.EP401

Diabetes, Metabolic Syndrome and Obesity: Targets and Therapy

Dovepress

Publish your work in this journal

Diabetes, Metabolic Syndrome and Obesity: Targets and Therapy is an international, peer-reviewed open-access journal committed to the rapid publication of the latest laboratory and clinical findings in the fields of diabetes, metabolic syndrome and obesity research. Original research, review, case reports, hypothesis formation, expert opinion

and commentaries are all considered for publication. The manuscript management system is completely online and includes a very quick and fair peer-review system, which is all easy to use. Visit <http://www.dovepress.com/testimonials.php> to read real quotes from published authors.

Submit your manuscript here: <https://www.dovepress.com/diabetes-metabolic-syndrome-and-obesity-targets-and-therapy-journal>

Capítulo IV

“PDX1-MODY: a rare cause of monogenic diabetes observed in a Brazilian family”

Formas monogênicas e poligênicas associadas a modificações no gene *PDX1* já foram descritas no mundo, entretanto, casos de PDX1-MODY são relatos raros na literatura. Neste Capítulo abordaremos o relato da segunda família descrita no Brasil com diabetes monogênico ocasionado devido a uma modificação no gene *PDX1*. Os estudos *in silico* e a ausência desta variante no grupo normoglicêmico testado, corroboraram como sendo esta a causa de diabetes nesta família. Neste estudo realizamos o levantamento de casos PDX1-MODY já descritos, sendo a família reportada neste Capítulo a oitava reportada no mundo. As comparações clínicas entre os oito casos-index já descritos na literatura revelaram que a maior parte dos pacientes são diagnosticados no início da fase adulta, como esperado para MODY, e a maioria dos pacientes são tratados com insulina.

Publicado na revista: *European Journal of Medical Genetics* 2021;64:104194.

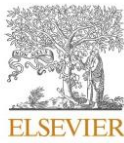

PDX1-MODY: A rare missense mutation as a cause of monogenic diabetes

Gabriella de M. Abreu Miss, MSc.^{a,*}, Roberta M. Tarantino^{b,c}, Ana Carolina P. de Fonseca^{a,d}, Ritiele B. de Souza^a, Camila A.P.D. Soares^a, Pedro H. Cabello^{a,e}, Melanie Rodacki^b, Lenita Zajdenverg^b, Verônica M. Zembrzuski^a, Mário Campos Junior^a

^a Human Genetics Laboratory, Oswaldo Cruz Institute, Oswaldo Cruz Foundation, Rio de Janeiro, Brazil

^b Diabetes and Nutrology Section, Internal Medicine Department, Federal University of Rio de Janeiro, Rio de Janeiro, Brazil

^c Ambulatory of Diabetes, State Institute for Diabetes and Endocrinology Luiz Capriglione, Rio de Janeiro, Brazil

^d Laboratory of Immunopharmacology, Oswaldo Cruz Institute, Oswaldo Cruz Foundation, Rio de Janeiro, Brazil

^e Laboratory of Genetics, School of Health Science, University of Grande Rio, Rio de Janeiro, Brazil

ARTICLE INFO

Keywords:

Diabetes mellitus
Monogenic diabetes
MODY
PDX1
MODY4
Mutation

ABSTRACT

Maturity-Onset Diabetes of the Young type 4 is a rare form of diabetes mellitus, caused by mutations in the *PDX1* gene. However, only a few mutations in this gene have been associated as a cause of monogenic diabetes up to date. It makes difficult to create a clinical manifestation profile of this disease and, consequently, to improve the therapeutic management for these patients. Here we report a normal weight woman, diagnosed with diabetes mellitus at 27 years old, during her first pregnancy. At the time of the recruitment, she was 40 years old and had a body mass index of 23.9 kg/m², glycated hemoglobin level of 9.6%, and fasting plasma glucose (FPG) of 254 mg/dL. She presented no diabetic complications and she was being treated with insulin. She reported a family history of diabetes mellitus characteristic of an autosomal dominant mode of inheritance. Molecular analysis of the *PDX1* gene revealed the missense variant c.532G > A (p.(Glu178Lys)) segregating from the patient to her son, reported as diabetic. It was absent in her healthy daughter. The c.532G > A seems to be a rare variant, absent in human variants databases, and among 86 normoglycemic controls. Eight in silico algorithms classified this variant as probably pathogenic. Additionally, analysis of the evolutionary conservation showed the glutamic acid in the position 178 of PDX-1 protein as conserved among several species. Our findings reinforce the importance of screening rare MODY genes among families with suspicion of monogenic diabetes to help better understand the clinical manifestations of this disease.

1. Introduction

Mutations in genes that express transcription factors that disrupt the insulin metabolism have been recognized as genetic causes of diabetes mellitus (DM) monogenic forms (Firdous et al., 2018). Among these genes, *Pancreatic and Duodenal Homeobox 1* (*PDX1*; OMIM #600733), also known as Maturity-Onset Diabetes of the Young 4 (MODY4; OMIM #606392), encodes PDX-1 protein that is required for normal pancreatic β -cell development and function (Stoffers et al., 1997b).

PDX-1 is a homeodomain transcription factor implicated in the regulation of genes expressed in pancreatic β -cells, such as Glucose Transporter 2 (GLUT2) (Waeber et al., 1996). Studies in mice showed that *Pdx1*^{-/-} mutants had pancreas agenesis (Jonsson et al., 1994) and *Pdx1*^{+/-} mice presented normal fasting blood glucose (FBG) (Brissova

et al., 2002). However, *Pdx1*^{+/-} mice also showed impaired glucose tolerance (IGT), reduction in insulin secretion, and lower expression of *Pdx1* and *Glut2* (Brissova et al., 2002).

To date, *PDX1* variants segregating with monogenic diabetes (*PDX1*-MODY) remains limited to a few families worldwide (Anik et al., 2015; Caetano et al., 2018; Chapla et al., 2015; Deng et al., 2019; Fajans et al., 2010; Schwitzgebel et al., 2003; Stoffers et al., 1997a). Due to its rarity, the clinical characteristics of patients harboring *PDX1* mutations remain still unclear. In this context, this study aimed to sequence the coding region of the *PDX1* gene in a sample from Brazil with clinical manifestations of monogenic diabetes.

* Corresponding author. Human Genetics Laboratory, Oswaldo Cruz Institute, Oswaldo Cruz Foundation, Leônidas Deane Building, room 615, 21040-360; 4365 Brasil Avenue, Rio de Janeiro, RJ, Brazil.

E-mail address: gabriella.abreu@ioc.fiocruz.br (G.M. Abreu).

<https://doi.org/10.1016/j.ejmg.2021.104194>

Received 26 August 2020; Received in revised form 4 March 2021; Accepted 14 March 2021

Available online 18 March 2021

1769-7212/© 2021 Elsevier Masson SAS. All rights reserved.

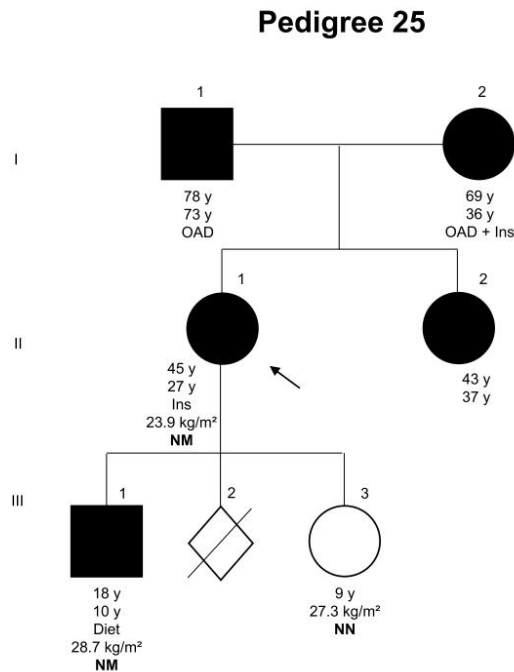

Fig. 1. Family pedigree P25 with *PDX1* c.532G > A p.(Glu178Lys) mutation. Filled symbols represent patients with diabetes and empty symbols are non-diabetic individuals. A triangle with a slash extending through symbol indicates neonatal death. The present age of the individuals are shown below the symbols (years), followed by age of diagnosis (years), the most recent treatment, body mass index (kg/m²) and genotype interpretation. OAD: oral anti-diabetic agents; Ins: insulin; MN: heterozygous for *PDX1* c.532G > A; NN: normal for *PDX1* c.532G > A; An arrow indicates the index case.

2. Patient's data

The patient P25 is a normal weight woman of 46 years old from the Northeast region of Brazil. She was diagnosed with DM at 27 years old during her first pregnancy. She was treated with metformin and presented negative anti-GAD (Glutamic Acid Decarboxylase) and anti-IA-2 (Islet Antigen-2). During her second pregnancy, at 33 years old, her baby died at delivery. She reported that hyperglycemia was measured at that time and she initiates insulin therapy. At her third pregnancy, she was 34 years old, and gave birth to a girl of 2.795 kg by cesarean section delivery at term. During this pregnancy, she showed a glycated hemoglobin (HbA1c) level of 6.2%, fasting plasma glucose (FPG) of 110 mg/dL and she was managed with insulin 0.4 U/kg/d (total dose of NPH insulin 24 U/d and total regular fast-acting insulin of 2 U/d). At the time of recruitment for this study, she was 40 years old, her body mass index (BMI) of 23.9 kg/m², HbA1c level of 9.6%, FPG of 254 mg/dL, thyroid-stimulating hormone (TSH) of 0.625 mIU/L, free thyroxine 4 (Ft4) of 1.23 ng/dL and thyroid anti-peroxidase (anti-TPO) negative (14.5 IU/mL). She was on 0.6 U/kg/d basal bolus insulin treatment (total dose of NPH insulin 18 U/d and total regular fast-acting insulin of 22 U/d). By the time of her last medical evaluation, she was 46 years old; she presented an HbA1c level of 9.9%. She was managed with 1.6 U/kg/d basal bolus insulin treatment (total dose of NPH insulin 64 U/d and total regular fast-acting insulin of 30 U/d). The evolution of HbA1c versus the treatment with insulin over the years is shown in the Supplemental

Graphic S1. After 19 years since her diagnosis, she presented no diabetic microvascular complications, and normal funduscopy. Analysis of the proband's pedigree suggest an autosomal dominant inheritance of diabetes (Fig. 1). The patient reported both parents with diabetes; her mother was diagnosed at 36 years old and has been treated with insulin and metformin, while her father was diagnosed at 73 years old, and he has been managed with metformin. The proband also reported her older child, diagnosed with diabetes at 10 years old and one sister diagnosed at 37 years old. Her 18-year-old son is overweight (BMI: 28.6 kg/m²). At the age of 16 years, on his last clinical evaluation, he showed negative anti-GAD and anti-IA-2, C-peptide of 0.8 ng/mL, HbA1c ranging from 5.3% to 5.8%, FPG ranging from 105 to 113 mg/dL, and postprandial glucose (PPG) of 140 mg/dL. He has been managing the hyperglycemia with nutritional therapy; however, he reported to have abandoned treatment and medical care for the past two years. At the admission on this study, his random capillary blood glucose (RCBG) was 211 mg/dL. At that moment, it was reported that the overweight proband daughter did not present hyperglycemia (BMI: 27.3 kg/m²; postprandial capillary glucose [PCG]: 138 mg/dL).

3. Ethics statement

This study protocol was approved by The Ethics and Research Committee of the Clementino Fraga Filho University Hospital (CAAE n° 04232512.4.0000.5257) and by the State Institute for Diabetes and Endocrinology Luiz Capriglione (CAAE n° 04232512.4.3001.5266). The participants were informed about the aim of this study and provided verbal and written consent.

4. Methods

4.1. Patient's recruitment

In the present cross-sectional observational study, we recruited 43 unrelated Brazilian patients with clinical characteristics of monogenic diabetes (18 males [41.9%] and 25 females [58.1%]; average age of diagnosis [AOD]: 21 ± 10.3 years) from the Clementino Fraga Filho University Hospital and from the State Institute for Diabetes and Endocrinology Luiz Capriglione. Patients who fulfilled all inclusion criteria were: 1) age at onset ≤ 40 years; 2) positive family history of diabetes in at least two generations; and 3) negative β-cells anti-GAD and anti-IA-2 autoantibodies. Patients with type 1 DM, obesity (BMI ≥ 30 kg/m² or ≥ 95th percentile for age at diagnosis), history of diabetic ketoacidosis at diabetes onset, clinical signs of insulin resistance and the presence of secondary causes of diabetes were excluded. All patients were previously screened for *GCK* or *HNF1A* (based on the clinical phenotype), *HNF4A* and *HNF1B*, and no mutations were observed. Family members of mutation carriers were recruited to this study for segregation analysis. Eighty-six controls (42 males and 44 females; average age: 32 ± 9 years; BMI average: 22.6 ± 1.7 kg/m²) without DM were screened to investigate the possible recurrence of the observed mutations in healthy individuals. Inclusion criteria for the control subject were as follows: 1) FPG < 100 mg/dL and HbA1c < 5.7%; 2) BMI ≤ 24.9 kg/m²; and 3) individuals without a family history of DM.

4.2. Molecular genetics

Genomic DNA from the probands and normoglycemic controls were isolated from peripheral blood leukocytes using the QIAamp DNA Blood Mini Kit (Qiagen, Hilden, Germany). Genomic DNA from the proband's family members were collected and extracted from buccal epithelial cells as previously described (Aidar and Line, 2007). The entire coding region of the *PDX1* gene was sequenced by Sanger sequencing.

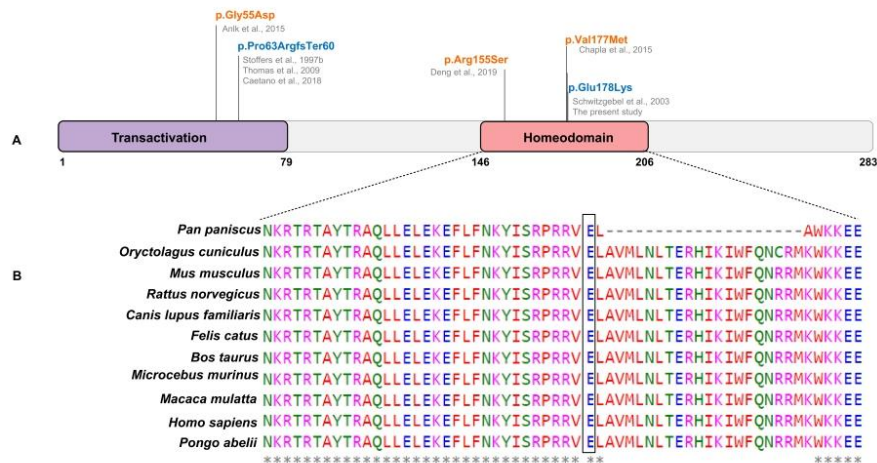

Fig. 2. Schematic representation of PDX-1 protein and location of the mutations as reported in the literature associated to MODY (orange) and MODY and Neonatal Diabetes (blue) (A). Alignment of PDX-1 homeodomain across species by Clustal Omega. Black dashed indicated the amino acid position of PDX1 p.(Glu178Lys) identified in the patient P25. *Pan paniscus* (ENSPPAP00000019094); *Oryctolagus cuniculus* (ENSOCUP00000004229); *Mus musculus* (ENSMUSP000000082729); *Rattus norvegicus* (ENSRNOP000000066935); *Canis lupus familiaris* (ENSCAFP00000030032499); *Felis catus* (ENSFCAP00000029882); *Bos Taurus* (ENSBTAP00000014141); *Microcebus murinus* (ENSMICP000000041397); *Macaca mulatta* (ENSMMUP00000078156); *Homo sapiens* (ENSP000000370421); *Pongo abelii* (ENSPYP000000005967) (B). (For interpretation of the references to colour in this figure legend, the reader is referred to the Web version of this article.)

4.3. Bioinformatics analysis

In order to investigate the previous occurrence of PDX1 variants identified in our study, they were checked against the following public databases: PubMed, Clinvar, dbSNP (<https://www.ncbi.nlm.nih.gov/>), Human Genome Mutation Database (HGMD) (<http://www.hgmd.cf.ac.uk/ac/>), gnomAD (<https://gnomad.broadinstitute.org/>), and the On-line Archive of Brazilian Mutations (ABraOM; <http://abraom.ib.usp.br/>) (Naslavsky et al., 2017). Missense variants that were absent in the control group and were not classified as likely benign by ClinVar were considered to have a potential impact on the protein and were further tested by in silico predictions. Eight different in silico pathogenicity prediction algorithms were used: 1) Revel (Ioannidis et al., 2016); 2) WS-SNPs&GO (Capriotti et al., 2013); 3) MutPred (Pejaver et al., 2017); 4) SNAP (Bromberg and Rost, 2007); 5) M-CAP (Jagadeesh et al., 2016); 6) CADD (Rentzsch et al., 2019); 7) Align-GVGD (Tavtigian et al., 2008); and 8) PANTHER-PSEP (Tang and Thomas, 2016). The Ensembl *PDX1* transcript ENST00000381033.4 (NM_000209; GRCh37.p13) was used as reference (<https://www.ensembl.org/index.html>). In addition, to evaluate amino acid conservation we performed a multiple sequence alignment by Clustal Omega (Version 1.2.4) (<https://www.ebi.ac.uk/Tools/msa/clustalo/>). The Ensembl reference transcript of the *PDX1* gene ENST00000381033.5 (PDX1; NM_000209.4; GRCh38.p13) was used as reference.

5. Results

The p.(Glu178Lys), NG_008183.1 (NM_000209.4): c.532G > A identified in the patient P25 seems to be potentially pathogenic (Supplemental Fig. S1), because it was: 1) absent in ABraOM and gnomAD databases; 2) classified as pathogenic by ClinVar (Supplemental Table S1); 3) absent in healthy individuals; 4) predicted to be probably pathogenic for all eight in silico algorithms (Supplemental Table S2); 5) the glutamic acid in the position 178 of PDX-1 homeodomain is evolutionary conserved among several species (Fig. 2); 6) and the NM_000209.4: c.532G > A segregates with the disease in the tested

individuals (Fig. 1). However, we were not able to recruit and test others relatives with diabetes as the patient's father, mother, and sister (Fig. 1. Individuals I-1, I-2, II-2, respectively).

6. Discussion

Since its first report (Stoffers et al., 1997b), variants in the *PDX1* gene have been associated to multiples types of DM, including monogenic forms of the disease (Fig. 2). The PDX1 c.532G > A identified in the present study was firstly found in a compound heterozygous girl (PDX1 c.492G > T [p.Glu164Asp] and c.532G > A [p.Glu178Lys]) diagnosed with Neonatal DM (NDM). She presented intrauterine growth retardation and pancreatic agenesis. She was treated with insulin and replacement of pancreatic exocrine enzymes. Each mutation was inherited from her non-consanguineous parents, who had high normal fasting blood sugar levels and no glucose intolerance at that moment. Her father (37 years old; BMI: 26 kg/m²) carried the c.532G > A and presented a family history of type 2 DM (T2-DM) (Schwitzgebel et al., 2003). This mutation seems to decrease PDX-1 half-life, which could prevent the proper PDX1 self-activation and consequently a decrease in protein level (Schwitzgebel et al., 2003).

Nicolino et al. (2010) identified the PDX1 c.533A > G (p.Glu178Gly) missense mutation in the same codon of the variant identified in our patient P25 (p.Glu178Lys). It was found in homozygosis in two Moroccan cousins with Permanent Neonatal Diabetes Mellitus (PNDM); both were underweight for the gestational age and presented pancreatic exocrine enzymes insufficiency. The proband had normal pancreas size; however, an ultrasound of his cousin revealed the presence of the pancreas head but was unable to show the body and the tail. The cousins parents carried the c.533A > G in heterozygosis and had normal FPG and normal glucose tolerance; however, they presented low insulin secretory response during oral glucose tolerance test (OGTT) (Nicolino et al., 2010).

Until now, at least six probands with clinical manifestations of MODY and two probands with NDM with family members with MODY phenotype were reported harboring variants in the *PDX1* (Ank et al.,

2015; Caetano et al., 2018; Chapla et al., 2015; Deng et al., 2019; Fajans et al., 2010; Mangrum et al., 2015; Stoffers et al., 1997a; Thomas et al., 2009) (Supplemental Table S3). Taken together, the average AOD ranged from birth, in the NDM cases (Fajans et al., 2010; Stoffers et al., 1997a), to 27 years old, in our P25 patient. The BMI average, excluding neonatal cases, was $23.65 \pm 1.27 \text{ kg/m}^2$. The majority of the index cases were men (5/8). Among the 42 PDX1 carriers (proband and relatives), 32 (76.19%) presented hyperglycemia and 10 (23.81%) did not show glycemic alteration at the moment of the study or did not reported. Moreover, within these studies, 11 family members of the reported probands presented hyperglycemia but did not carry the PDX1 mutation that segregated in their family. Multifactorial forms of diabetes coexisting with monogenic diabetes could be a possible explanation for this observation (Fajans et al., 2010). Concerning the therapeutic management of the index-cases, with exception of the patient with PDX1 c.463C > A that was reported to manage his hyperglycemic level by exercises only (Deng et al., 2019), the remaining seven patients reported the use of insulin as the main chosen treatment.

Here, we highlight the importance to include the analysis of the PDX1 gene in the diagnosis of monogenic forms of DM. Heterozygous mutations in PDX1 may cause PDX1-MODY diabetes and we believe that this is the case of the family reported here. The clinical manifestation of this rare form of diabetes needs to be further elucidated by additional studies; it will be possible to create a more specific profile indicative of PDX1-MODY with more clinical cases reported. The present study has some limitations, we were not able to test the patient's father, mother and sister for the detected mutation, our sample size was small and we did not perform functional studies to evaluate the impact of the PDX1 c.532G > A variant on the protein structure and function.

CRediT authorship contribution statement

Gabriella de M. Abreu: Conceptualization, Methodology, Validation, Formal analysis, Investigation, Writing – original draft, Project administration. **Roberta M. Tarantino:** Conceptualization, Methodology, Resources, Writing – review & editing, Supervision, Project administration. **Ana Carolina P. da Fonseca:** Resources, Writing – review & editing. **Ritiele B. de Souza:** Software, Formal analysis, Writing – review & editing. **Camila A.P.D. Soares:** Investigation, Writing – review & editing. **Pedro H. Cabello:** Resources, Writing – review & editing, Funding acquisition, Supervision. **Melanie Rodacki:** Resources, Writing – review & editing, Funding acquisition, Supervision. **Lenita Zajdenverg:** Resources, Writing – review & editing, Funding acquisition. **Verônica M. Zembrzuski:** Resources, Writing – review & editing, Funding acquisition. **Mário Campos Junior:** Resources, Writing – review & editing, Supervision, Funding acquisition, Project administration.

Declaration of competing interest

The authors declare no conflict of interest.

Acknowledgments

The authors are grateful to the patients and their families and to the DNA Sequencing Platform (RPT01A) from Oswaldo Cruz Institute. The National Council for Scientific and Technological Development (CNPq), Coordination for the Improvement of Higher Education Personnel (CAPES), Carlos Chagas Filho Foundation for Research Support of the State of Rio de Janeiro (FAPERJ) and Oswaldo Cruz Institute (IOC) supported this work.

Appendix A. Supplementary data

Supplementary data to this article can be found online at <https://doi.org/10.1016/j.ejmg.2021.104194>.

References

- Aidar, M., Line, S.R.P., 2007. A simple and cost-effective protocol for DNA isolation from buccal epithelial cells. *Braz. Dent. J.* 18, 148–152. <https://doi.org/10.1590/S0103-64402007000200012>.
- Anik, A., Çatlı, G., Abacı, A., Sari, E., Yeşilkaya, E., Korkmaz, H.A., Demir, K., Altuncik, A., Tuhan, H.U., Kızıldağ, S., Özkan, B., Ceylaner, S., Böber, E., 2015. Molecular diagnosis of maturity-onset diabetes of the young (MODY) in Turkish children by using targeted next-generation sequencing. *J. Pediatr. Endocrinol. Metab.* 28, 1265–1271. <https://doi.org/10.1515/jpem-2014-0430>.
- Brissova, M., Shiota, M., Nicholson, W.E., Gannon, M., Knobel, S.M., Piston, D.W., Wright, C.V.E., Powers, A.C., 2002. Reduction in pancreatic transcription factor PDX-1 impairs glucose-stimulated insulin secretion. *J. Biol. Chem.* 277, 11225–11232. <https://doi.org/10.1074/jbc.M111272200>.
- Bromberg, Y., Rost, B., 2007. SNAP: predict effect of non-synonymous polymorphisms on function. *Nucleic Acids Res.* 35, 3823–3835. <https://doi.org/10.1093/nar/gkm238>.
- Caetano, L.A., Santana, L.S., Costa-Riquetto, A.D., Lerario, A.M., Nery, M., Nogueira, G. F., Ortega, C.D., Rocha, M.S., Jorge, A.A.L., Teles, M.G., 2018. PDX1-MODY and dorsal pancreatic agenesis: new phenotype of a rare disease. *Clin. Genet.* 93, 382–386. <https://doi.org/10.1111/cge.13044>.
- Capriotti, E., Calabrese, R., Farielli, P., Martelli, P., Altman, R.B., Casadio, R., 2013. WS-SNP&GO: a web server for predicting the deleterious effect of human protein variants using functional annotation. *BMC Genom.* 14, S6. <https://doi.org/10.1186/1471-2164-14-S3-S6>.
- Chapla, A., Mruthyunjaya, M.D., Asha, H.S., Varghese, D., Varshney, M., Vasan, S.K., Venkatesan, P., Nair, V., Mathai, S., Paul, T.V., Thomas, N., 2015. Maturity onset diabetes of the young in India - a distinctive mutation pattern identified through targeted next-generation sequencing. *Clin. Endocrinol.* 82, 533–542. <https://doi.org/10.1111/ce.12541>.
- Deng, M., Xiao, X., Zhou, L., Wang, T., 2019. First case report of maturity-onset diabetes of the young type 4 pedigree in a Chinese family. *Front. Endocrinol.* 10, 1–5. <https://doi.org/10.3389/fendo.2019.00406>.
- Fajans, S.S., Bell, G.L., Paz, V.P., Below, J.E., Cox, N.J., Martin, C., Thomas, I.H., Chen, M., 2010. Obesity and hyperinsulinemia in a family with pancreatic agenesis and MODY caused by the IPF1 mutation Pro636X60. *Transl. Res.* 156, 7–14. <https://doi.org/10.1016/j.trsl.2010.03.003>.
- Firdous, P., Nissar, K., Ali, S., Ganai, B.A., Shabir, U., Hassan, T., Masoodi, S.R., 2018. Genetic testing of maturity-onset diabetes of the young current status and future perspectives. *Front. Endocrinol.* 9, 1–13. <https://doi.org/10.3389/fendo.2018.00253>.
- Ioannidis, N.M., Rothstein, J.H., Pejaver, V., Middha, S., McDonnell, S.K., Baheti, S., Musolf, A., Li, Q., Holzinger, E., Karyadi, D., Cannon-Albright, L.A., Teerlink, C.C., Stanford, J.L., Isaacs, W.B., Xu, J., Cooney, K.A., Lange, E.M., Schleutker, J., Carpten, J.D., Powell, L.J., Cussenot, O., Cancel-Tassin, G., Giles, G.G., MacInnis, R. J., Maier, C., Hsieh, C.-L., Wiklund, F., Catalona, W.J., Foulkes, W.D., Mandal, D., Eeles, R.A., Kote-Jarai, Z., Bustamante, C.D., Schaid, D.J., Hastie, T., Ostrander, E.A., Bailey-Wilson, J.E., Radivojac, P., Thibodeau, S.N., Whittemore, A.S., Sieh, W., 2016. REVEL: an ensemble method for predicting the pathogenicity of rare missense variants. *Am. J. Hum. Genet.* 99, 877–885. <https://doi.org/10.1016/j.ajhg.2016.08.016>.
- Jagadeesh, K.A., Wenger, A.M., Berger, M.J., Guturu, H., Stenson, P.D., Cooper, D.N., Bernstein, J.A., Bejerano, G., 2016. M-CAP eliminates a majority of variants of uncertain significance in clinical exomes at high sensitivity. *Nat. Genet.* 48, 1581–1586. <https://doi.org/10.1038/ng.3703>.
- Jonsson, J., Carlsson, L., Edlund, T., Edlund, H., 1994. Insulin-promoter-factor 1 is required for pancreas development in mice. *Nature* 371, 606–609. <https://doi.org/10.1038/371606a0>.
- Mangrum, C., Rush, E., Shivaswamy, V., 2015. Genetically targeted dipeptidyl peptidase-4 inhibitor use in a patient with a novel mutation of MODY type 4. *Clin. Med. Insights Endocrinol. Diabetes* 8. <https://doi.org/10.4137/CMED.S31926>. CMED. S31926.
- Naslavsky, M.S., Yamamoto, G.L., de Almeida, T.F., Ezquina, S.A.M., Sunaga, D.Y., Pho, N., Bozoldian, D., Sandberg, T.O.M., Brito, L.A., Lazar, M., Bernardo, D.V., Amaro, E., Duarte, Y.A.O., Lebrão, M.L., Passos-Bueno, M.R., Zatz, M., 2017. Exomic variants of an elderly cohort of Brazilians in the AbraOM database. *Hum. Mutat.* 38, 751–763. <https://doi.org/10.1002/humu.23220>.
- Nicolino, M., Claiborn, K.C., Senev, V., Boland, A., Stoffers, D.A., Julier, C., 2010. A novel hypomorphic PDX1 mutation responsible for permanent neonatal diabetes with subclinical exocrine deficiency. *Diabetes* 59, 733–740. <https://doi.org/10.2337/db09-1284>.
- Pejaver, V., Urresti, J., Lugo-Martinez, J., Pagel, K.A., Lin, G.N., Nam, H.-J., Mort, M., Cooper, D.N., Sebat, J., Iakoucheva, L.M., Mooney, S.D., Radivojac, P., 2017. MutPred2: Inferring the Molecular and Phenotypic Impact of Amino Acid Variants, 134981. <https://doi.org/10.1101/134981> bioRxiv.
- Rentzsch, P., Witten, D., Cooper, G.M., Shendure, J., Kircher, M., 2019. CADD: predicting the deleteriousness of variants throughout the human genome. *Nucleic Acids Res.* 47, D886–D894. <https://doi.org/10.1093/nar/ghy1016>.
- Schwitzgebel, V.M., Mamin, A., Brun, T., Ritz-Laser, B., Zaike, M., Maret, A., Jomayvaz, F.R., Theintz, G.E., Michielin, O., Melloud, D., Philippe, J., 2003. Agnesis of human pancreas due to decreased half-life of insulin promoter factor 1. *J. Clin. Endocrinol. Metab.* 88, 4398–4406. <https://doi.org/10.1210/jc.2003-030046>.
- Stoffers, D.A., Ferrer, J., Clarke, W.L., Habener, J.F., 1997a. Early-onset type-II diabetes mellitus (MODY4) linked to IPF1. *Nat. Genet.* 17, 138–139. <https://doi.org/10.1038/ng1097-138>.

- Stoffers, D.A., Zinkin, N.T., Stanojevic, V., Clarke, W.L., Habener, J.F., 1997b. Pancreatic agenesis attributable to a single nucleotide deletion in the human IPF1 gene coding sequence. *Nat. Genet.* 15, 106–110. <https://doi.org/10.1038/ng0197-106>.
- Tang, H., Thomas, P.D., 2016. PANTHER-PSEP: predicting disease-causing genetic variants using position-specific evolutionary preservation. *Bioinformatics* 32, 2230–2232. <https://doi.org/10.1093/bioinformatics/btw222>.
- Tavtigian, S.V., Byrnes, G.B., Goldgar, D.E., Thomas, A., 2008. Classification of rare missense substitutions, using risk surfaces, with genetic- and molecular-epidemiology applications. *Hum. Mutat.* 29, 1342–1354. <https://doi.org/10.1002/humu.20896>.
- Thomas, I.H., Saini, N.K., Adhikari, A., Lee, J.M., Kasa-vubu, J.Z., Vazquez, D.M., Menon, R.K., Chen, M., Fajans, S.S., 2009. Neonatal diabetes mellitus with pancreatic agenesis in an infant with homozygous IPF-1 Pro63fsX60 mutation. *Pediatr. Diabetes* 10, 492–496. <https://doi.org/10.1111/j.1399-5448.2009.00526.x>.
- Waeber, G., Thompson, N., Nicod, P., Bonny, C., 1996. Transcriptional activation of the GLUT2 gene by the IPF-1/STF-1/IDX-1 homeobox factor. *Mol. Endocrinol.* 10, 1327–1334. <https://doi.org/10.1210/mend.10.11.8923459>.

Supplemental Figure S1. Electropherograms of the variants in *PDX1* gene identified in this study.

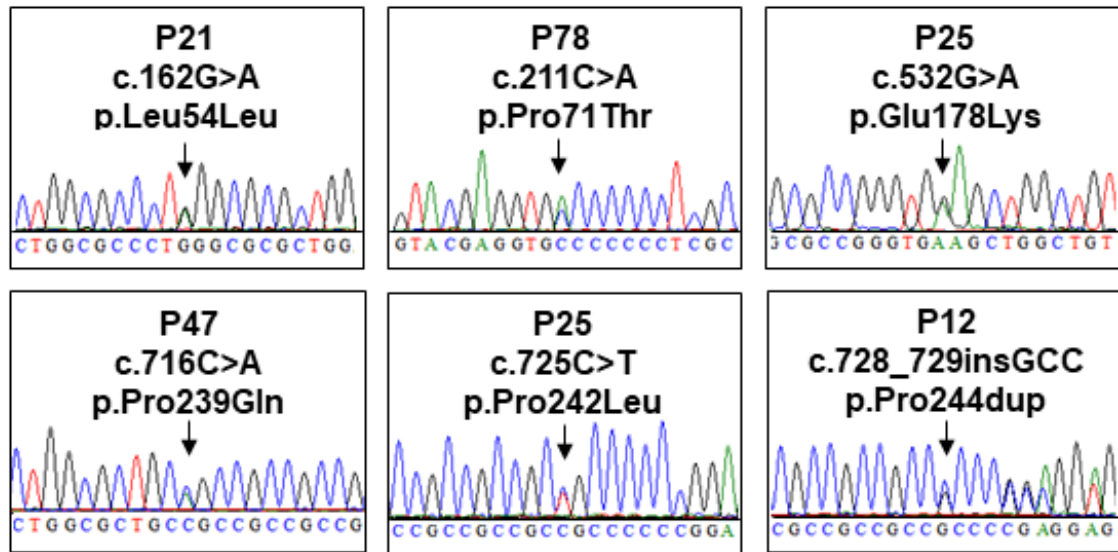

Supplemental Table S1. Variants identified in *PDX1* gene in this study

Patient	cDNA level	Protein level	dbSNP	gnomAD allele frequency	ABraOM allele frequency	ClinVar
P21	c.162G>A	p.(Leu54Leu)	rs28509441	0.004135	0.010906	Benign/Likely benign
P78	c.211C>A	p.(Pro71Thr)	rs564129447	0.0001442	-	Not reported
P25	c.532G>A	p.(Glu178Lys)	rs80356662	-	-	Pathogenic
P47	c.716C>A	p.(Pro239Gln)	rs199644078	0.006879	0.004934	Likely benign
P25	c.725C>T	p.(Pro242Leu)	rs193922358	0.001223	-	Conflicting interpretations of pathogenicity Likely benign(3);Uncertain significance(1)
P12	c.728_729insGCC	p.(Pro244dup)	rs193922357	0.00001959	0.016474	Conflicting interpretations of pathogenicity/ Benign/ Uncertain significance

Supplemental Table S2. *In silico* analysis of point variants with unknown pathogenicity identified in *PDX1* gene

Prediction tool	c.211C>A p.(Pro71Thr)		c.532G>A p.(Glu178Lys)		c.725C>T p.(Pro242Leu)	
	Score	Prediction	Score	Prediction	Score	Prediction
Revel	0.503	Likely disease causing	0.958	Likely disease causing	0.122	Likely benign
WS-SNPs&GO	0.217	Neutral	0.975	Disease	0.267	Neutral
SNAP	-17	Neutral	92	Effect	-3	Neutral
Fathmm	-2.72	Damaging	-4.04	Damaging	-2.89	Damaging
M-CAP	0.446	Possibly pathogenic	0.832	Possibly pathogenic	0.851	Possibly pathogenic
CADD	25.3	Likely benign	33	Likely deleterious	16.30	Likely benign
Align-GVGD	C35	Likely deleterious	C55	Likely deleterious	C65	Likely deleterious
PANTHER-PSEP	362	Possibly damaging	911	Probably damaging	176	Probably benign
Total = 8	5/8 = harmful		8/8 = harmful		3/8 = harmful	

Revel: <https://sites.google.com/site/revelgenomics/downloads>, WS-SNP&GO: <http://snps.biofold.org/snps-and-go/>, SNAP: <http://www.rostlab.org/services/SNAP>, Fathmm: <http://fathmm.biocompute.org.uk/index.html>, MCAP: <http://bejerano.stanford.edu/mcap/>, CADD: <https://cadd.gs.washington.edu/snv>, Align GVGD: http://agvgd.hci.utah.edu/agvgd_input.php, PANTHER-PSEP: <http://www.pantherdb.org/tools/csnpscore.do>.

Supplemental Table S3. Summary of mutations associated to Maturity-Onset Diabetes of the Young type 4

P	Mutation cDNA level	Mutation protein level	Zigosity	Origin	AOD (years)	Sex	ALE (years)	BMI (kg/m ²)	Current treatment	DM/ND relatives tested for the mutation*	Reference
1	c.164G>A	p.Gly55Asp	Hetero	Turkish	14	F	NA	23†	Insulin	1 NM/.	(Anık et al., 2015)
2	c.188delC	p.Pro63Argfs Ter60	Hetero	Brazilian	14	M	52	21.8	Gliclazide and insulin	2 NN, 1 NM/ 4 NN	(Caetano et al., 2018)
3	c.188delC	p.Pro63Argfs Ter60	Homo#	American at birth	F	5	NA	NA	Insulin and pancreatic exocrine enzymes	1 NN, 10 NM/ 14 NN, 1 NM	(Stoffers et al., 1997a, 1997b)
4	c.188delC	p.Pro63Argfs Ter60	Homo#	American at birth	M	1	Normal	Normal	Insulin and pancreatic enzymes	8 NN, 9 NM/ 22 NN, 9 NM	(Fajans et al., 2010; Thomas et al., 2009)
5	c.463C>A	p.Arg155Ser	Hetero	Chinese	14	M	14	24.4	None	2 NM/.	(Deng et al., 2019)
6	c.529G>A	p.Val177Met	Hetero	Indian	26	M	40	24.4	Insulin	NA	(Chapla et al., 2015)
7	c.532G>A	p.Glu178Lys	Hetero	Brazilian	27	F	45	25.3	Insulin	1 NM/ 1 NN	Present study
8	c.694_697del GGCGinsAGCT	p.Gly232Serfs Ter2	Hetero	NA	26	M	26	23	Insulin	NA	(Mangrum et al., 2015)

P: Proband; DM: Diabetes mellitus; ND: Non-Diabetes mellitus; AOD: Age of Diagnosis; ALE: Age at last evaluation; BMI: Body Mass Index; NA: Not available; F: Female; M: Male; # Patient with Neonatal Diabetes Mellitus; *Allele N: Normal and Allele M: Mutated; †: 85th percentile; DM might include Impaired Glucose Tolerance (IGT) and Impaired Fasting Glucose (IFG).

Supplemental Graphic S1. Response to insulin treatment over the years (Patient P25)

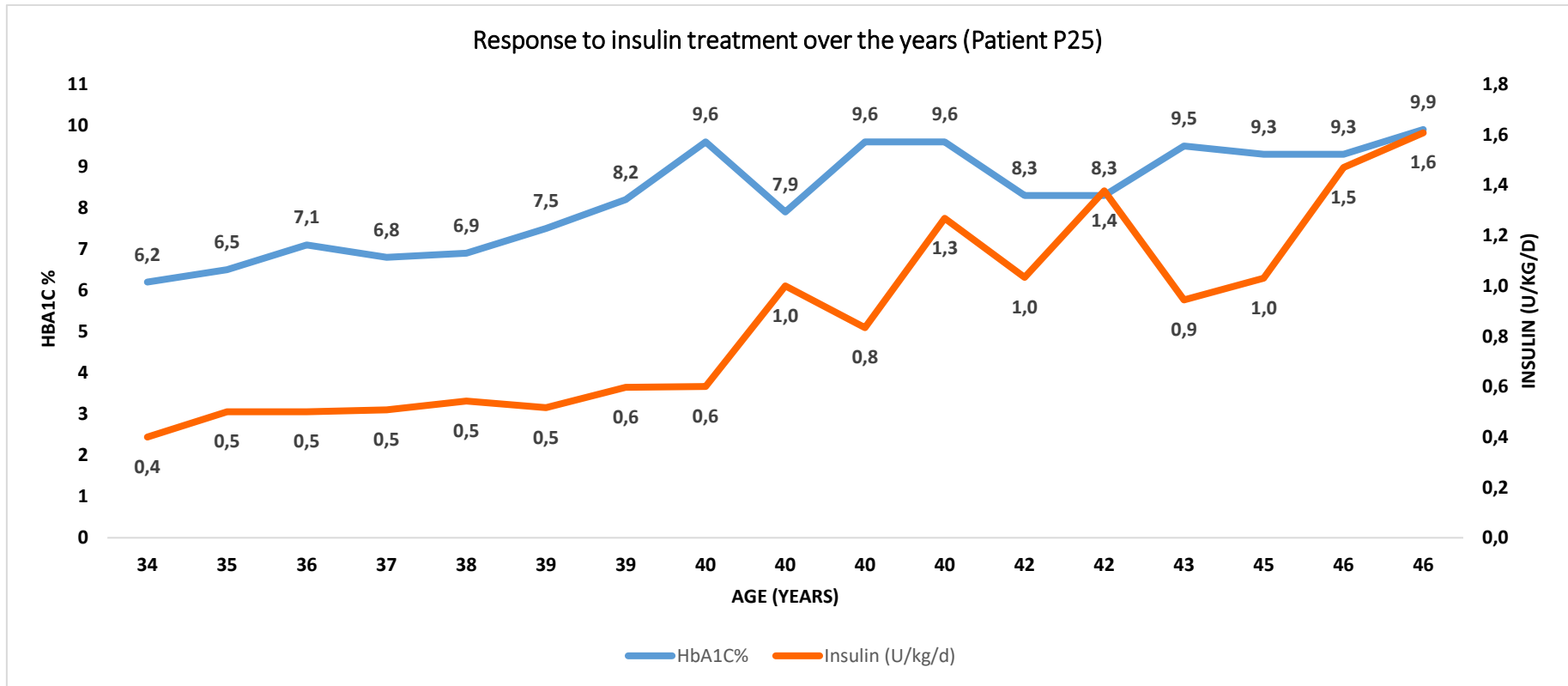

Capítulo V

“Identification of mutations responsible for monogenic forms of diabetes in Brazil”

Neste Capítulo será exposta a descrição clínica de pacientes com diabetes monogênico bem como o resultado da análise molecular de 10 genes associados. Do total de 57 probandos estudados, foi possível o diagnóstico de 20 pacientes (35%). A confirmação molecular do diagnóstico das formas mais conhecidas, como o GCK-MODY e o HNF1A-MODY, teve aplicação direta no direcionamento do melhor tratamento para o paciente. Além disso, estes dados trazem informações sobre a frequência das modificações nestes genes em casuística brasileira. Nós descrevemos neste Capítulo em maiores detalhes modificações identificadas nos genes *HNF4A* e *HNF1B*, além de um caso inesperado de um paciente com mutação no gene mitocondrial *MT-TL1*. A análise de segregação, análises *in silico* e a classificação da patogenicidade através do guia ACMG (do inglês, “American College of Medical Genetics and Genomics”) foram realizadas para as variantes identificadas nesse estudo e para as variantes anteriormente publicadas pelo nosso grupo, totalizando 30 variantes genômicas. As análises de bioinformática foram realizadas como ferramenta complementar para um resultado de patogenicidade mais confiável, principalmente para as formas raras. O diagnóstico molecular de pacientes com variantes nos genes mais frequentes, como o gene *GCK* se beneficiam através do tratamento personalizado. Todos os pacientes com GCK-MODY que estavam se tratando com insulina puderam ter seu tratamento interrompido. Já o relato das variantes nos genes raros contribuíram com a literatura para traçar um perfil clínico para essas formas ainda pouco conhecidas.

Os resultados do rastreamento dos 11 genes estão apresentados no **Anexo D** e o modelo de relatório de pesquisa gerado é mostrado no **Anexo E**.

Identification of mutations responsible for monogenic forms of diabetes in Brazil

Short title: Monogenic forms of diabetes in Brazil

Gabriella de Medeiros Abreu¹, Roberta Magalhães Tarantino², Ana Carolina Proença da Fonseca^{1,3}, Juliana Rosa Ferreira de Oliveira Andrade^{1,4}, Ritiele Bastos de Souza¹, Camila de Almeida Pereira Dias Soares¹, Amanda Cambraia¹, Pedro Hernan Cabello^{1,4}, Melanie Rodacki², Lenita Zajdenverg², Verônica Marques Zembruski¹ and Mário Campos Junior¹.

¹Human Genetics Laboratory, Oswaldo Cruz Institute, Oswaldo Cruz Foundation, Rio de Janeiro, Brazil

²Diabetes and Nutrology Section, Internal Medicine Department, Federal University of Rio de Janeiro, Rio de Janeiro, Brazil

³Laboratory of Immunopharmacology, Oswaldo Cruz Institute, Oswaldo Cruz Foundation, Rio de Janeiro, Brazil

⁴Laboratory of Genetics, School of Health Science, University of Grande Rio, Rio de Janeiro, Brazil

Correspondence author: Gabriella de Medeiros Abreu; Human Genetics Laboratory, Oswaldo Cruz Institute, Oswaldo Cruz Foundation, Leônidas Deane Building, room 615, 21040-360; 4365 Brasil Avenue, Rio de Janeiro – RJ – Brazil; Tel +55 21 3865 8192; E-mail: gabriella.abreu@ioc.fiocruz.br. Word Count: 5227

Abstract

Monogenic forms of diabetes *mellitus* represent a significant cause of this disease to be investigated. However, studies of the genetic causes of monogenic diabetes, especially in populations with mixed ethnic background as Brazil, are scarce. The aim of this study was to screen several genes associated with monogenic diabetes in Brazilian patients with recurrence of diabetes in their families. Fifty-seven probands with autosomal dominant history of diabetes and thirty-four relatives were enrolled in this study. The inclusion criteria for patients was age of onset ≤ 40 years old, BMI < 30 kg/m², at least two affected generations and negative anti-GAD and anti-IA2 antibodies. Analysis of *HNF4A*, *GCK*, *HNF1A*, *HNF1B*, *NEUROD1*, *KLF11*, *PAX4*, *INS*, *KCNJ11*, and *MT-TL1* genes were performed by Sanger sequencing. *In silico* algorithms were used to assess the potential pathogenic impact variants on protein structure and function. We identified a total of 20 patients with variants, 13 GCK-MODY, 4 HNF1A-MODY, and one variant in each of the following genes, *HNF4A*, *HNF1B* and *MT-TL1*. The segregation analysis was performed in 13 families. We described four novel variants, two in *GCK* (p.(Met115Val) [c.343A>G] and p.(Asp365Glu>Ter95) [c.1094_1095insGCGA]) and two in *HNF1A* (p.(Tyr163Ter) [c.489C>G] and p.(Val380Cys>Ter39) [c.1136_1137insC]). Taken together with previous results, our group revealed the presence of variants as the possible cause of monogenic diabetes in half of our cohort. Here we highlight the importance of screening for monogenic diabetes in admixed populations.

Keywords: Monogenic diabetes; MODY; Mitochondrial disease; Mutations

INTRODUCTION

Diabetes is a clinically and genetically variable group of metabolic diseases characterized by hyperglycemia. It is estimated that monogenic forms of DM represent approximately 2% of all cases of hyperglycemia (1). However, since these patients are frequently undiagnosed or misclassified as having type 1 DM (T1DM) or type 2 DM (T2DM), this number can be even higher. Monogenic diabetes includes neonatal diabetes *mellitus* (NDM), a rare form of diabetes, characterized by the onset before six months of life (2). Likewise, mitochondrial diabetes is caused by a single alteration in the *MT-TL1* gene in mtDNA, in most cases by the m.3243A>G (3). This variant can lead to a wide clinical spectrum, from asymptomatic carriers to oligosymptomatic or severe symptoms, as observed in progressive external ophthalmoplegia (PEO), maternally inherited diabetes and deafness (MIDD) and mitochondrial encephalomyopathy, lactic acidosis, and stroke-like episodes (MELAS) (4). In addition, the most common form of monogenic diabetes is the Maturity-Onset Diabetes of the Young (MODY).

MODY is classically defined as a mild diabetes with autosomal dominant inheritance, early age at onset and impaired insulin secretion with no defect in its action, and in some cases absence of insulin dependence (5). Since its first clinical description, variants in fourteen genes (*HNF4A*, *GCK*, *HNF1A*, *PDX1*, *HNF1B*, *NEUROD1*, *KLF11*, *CEL*, *PAX4*, *INS*, *BLK*, *ABCC8*, *KCNJ11* and *APPL1*) were described associated to this condition, presenting phenotypic, metabolic and genetic heterogeneity (for revision, (6)). The frequency of variants in each gene is variable, according to the genetic background of the population and the methodology applied. In this study, we aimed to identify variants in nine MODY genes and in

MT-TL1 (mtDNA) gene in Brazilian patients with clinical characteristics of monogenic diabetes.

MATERIALS AND METHODS

Patients

In this cross-sectional observational study were included patients who were treated at the Clementino Fraga Filho University Hospital and at the State Institute for Diabetes and Endocrinology Luiz Capriglione, from Rio de Janeiro, Brazil and their relatives. The inclusion criteria were patients with age at diagnosis (AAD) equal than or less to 40 years old; positive family history of DM in at least two generations, excluding the generation of the index case, and/or two or more first degree relatives at the same side of the family; and negative anti-GAD (Glutamic Acid Decarboxylase) and anti-IA2 (Islet Antigen 2) antibodies. The exclusion criteria were patients with T1DM with positive antibodies, obesity (Body Mass Index [BMI] ≥ 30 kg/m² or ≥ 95 th percentile at AAD), history of diabetic ketoacidosis at diabetes onset, clinical signs of insulin resistance and presence of secondary causes the disease. Patients were divided into two groups to be tested, *GCK* or *HNF1A*, according to their clinical manifestation. The *GCK* group (tested for the *GCK* gene) comprised patients most often asymptomatic that presented mild fasting hyperglycemia since birth ranging from 100 to 154 mg/dL, increase in glycaemia < 54 mg/dL after 75 g anhydrous dextrose and HbA1c $< 7.5\%$ (58 mmol/mol); and a evolutionarily stable disease (even without antidiabetic drugs); the remaining patients were included in *HNF1A* group (tested for the *HNF1A* gene).

Medical records were reviewed and participants were interviewed in order to obtain the following clinical information: AAD, duration of the disease, familiar history of DM, current

and previous treatment, anthropometric measurements (height, weight and BMI), blood pressure, laboratory blood tests (Fasting Plasma Glucose [FPG], HbA1c, anti-GAD, anti-IA2, C-reactive protein [CRP], thyroid-stimulating hormone [TSH], free thyroxine 4 [Ft4], thyroid anti-peroxidase [TPO]), and presence of retinopathy, nephropathy, neuropathy and renal cysts. This study protocol was approved by The Ethics and Research Committee of the Clementino Fraga Filho University Hospital (CAAE n° 04232512.4.0000.5257) and by the State Institute for Diabetes and Endocrinology Luiz Capriglione (CAAE n° 04232512.4.3001.5266). All participants were informed about the aim of this study and provided a written informed consent.

Molecular genetic analysis

Genomic DNA from the probands was isolated from peripheral blood leukocytes using QIAamp DNA Blood Mini Kit (Qiagen, Hilden, Germany) and the genomic DNA from their relatives was collected and extracted from buccal epithelial cells according to the protocol in the literature (7). Primers were designed for all coding regions of 10 genes (*HNFA4*, *GCK*, *HNFA1*, *HNFB1*, *NEUROD1*, *KLF11*, *PAX4*, *INS*, *KCNJ11* and *MT-TL1*) using Primer3Plus software (<http://www.bioinformatics.nl/cgi-bin/primer3plus/primer3plus.cgi>). The information of the primers, PCR reagents and cycling conditions were summarized in **Supplementary Table S1**. PCR products were purified by ExoSAP-IT® Reagent (Applied Biosystems, Vilnius, Lithuania), followed by Sanger sequencing reaction using the Big Dye Terminator Kit v3.1 (Applied Biosystems, Austin, TX, USA), conducted on an ABI 3130 Automatic Genetic Analyzer (Applied Biosystems). For variants considered to be likely pathogenic, orthogonal methodology was executed, including re-extraction of the sample,

testing and sequencing of the forward and reverse strands of the area of interest a second time, and sequencing of the exon containing the variant identified in family members samples.

Classification of variants

In order to investigate the previous occurrence of variants identified in our study, all variants were cross-checked against the follow public databases: PubMed, Clinvar, dbSNP (<https://www.ncbi.nlm.nih.gov/>), HGMD (<http://www.hgmd.cf.ac.uk/ac/>), gnomAD (<https://gnomad.broadinstitute.org/>) and the Online Archive of Brazilian Mutations (ABraOM; <http://abraom.ib.usp.br/>) (8). We classified the variants identified by our group according the published criteria of pathogenicity of the American College of Medical Genetics and Genomics and the Association for Molecular Pathology (ACMG/AMP) (Richards et al. 2015) available on VarSome (<https://varsome.com/>) (9).

All variants identified received the nomenclature recommended by the Human Genome Variation Society (<http://www.hgvs.org/mutnomen/>). For access the nomenclature of variants identified in the human mitochondrial DNA, we visited the Revised Cambridge reference sequence (rCRS) (<http://www.mitomap.org/MITOMAP/HumanMitoSeq>). Polymorphisms or synonymous variants reported are not included in this study. Variants not described in databases or published in scientific articles were referred as novel.

Bioinformatics analysis

For assess the potential impact of variants identified in this study and variants described in our previous studies (10–13), prediction scores were obtained from MutPred (<http://mutpred.mutdb.org/>) (14), FATHMM (v.2.3) (<http://fathmm.biocompute.org.uk/>) (15), VEST (v.4.0) (<http://cravat.us/CRAVAT/>) (16,17), SIFT (<https://sift.bii.a-star.edu.sg/>) (18), PolyPhen-2 (<http://genetics.bwh.harvard.edu/pph/index.html>) (19), Mutation Taster

(<http://www.mutationtaster.org/>) (20), PROVEAN (<http://provean.jcvi.org/index.php>) (21), and Mutation Assessor (<http://mutationassessor.org/r3/>) (22). For conservation scores LRT (http://www.genetics.wustl.edu/jflab/lrt_query.html) (23), GERP++ (<http://mendel.stanford.edu/SidowLab/downloads/gerp/>) (24), SiPhy (http://portals.broadinstitute.org/genome_bio/siphy/) (25), PhastCons and PhyloP (<http://compgen.cshl.edu/phast/>) (26) were used. Revel (<https://sites.google.com/site/revelgenomics/>) was applied to scores of these thirteen software (27). All analysis were done by the Ensembl Variant Effect Predictor (VEP) (<https://www.ensembl.org/Tools/VEP>) (28) and the results were retrieved from the dbNSFP (database for nonsynonymous SNP'S functional predictions) (29,30).

To predict the effect of the splice variant in the acceptor site, eight *in silico* analyses were performed. Scores prediction for the mutant allele were obtained from Adaptive Boosting Algorithm (ADA) (31), Random Forest (RF) (32) and MaxEntScan (33) tools provide by VEP (<https://www.ensembl.org/Tools/VEP>) (29) and the results were retrieved from the SNV splicing consensus regions database (dbscSNV) (34). While, NetGene2 (35,36) and HMM-gene (v.1.1) (37) (<https://services.healthtech.dtu.dk/>), NNSplice (v.0.9) (https://www.fruitfly.org/seq_tools/splice.html) (38), FSPLICE (v.1.0) (<http://www.softberry.com/berry.phtml?topic=fsplICE&group=programs&subgroup=gfind>), and Human Splicing Finder (v.3.1.) (HSF) (<https://www.genomnis.com/access-hsf>) (39) generate their prediction score for the wild-type allele and one for the mutant allele separately.

RESULTS

Fifty-seven Brazilian probands were studied, including 26 men and 31 women. The mean AAD was 19.09 ± 10.54 years. Nineteen probands were enrolled in *GCK* screening and 16

were studied for *HNF1A*. In addition, twenty-one negative patients for *HNF1A* and one patient negative for *GCK*, previous reported by our group (10), were included. Forty patients with no variants detected in *GCK* or *HNF1A* genes were screened for variants in *HNF4A*, *HNF1B*, *NEUROD1*, *KLF11*, *PAX4*, *INS*, *KCNJ11* and *MT-TL1*. The study sample formation is show in the **Table 1**. A total of 34 relatives from 13 families were recruited (18 men and 16 women; average age 36.3 ± 20.7 years, ranging from 0 to 74 years), in which 21 presented DM and 13 did not report hyperglycemia.

Molecular screening findings

In the present study, we identified 20 patients with variants in our cohort: thirteen patients with variants in the *GCK* (13/19 - 68.4%), four patients with variants in the *HNF1A* (4/16 - 25%) and one variant in each of the following genes *HNF4A*, *HNF1B* and *MT-TL1* (1/40 - 2.5%) (**Figure 1**). Taken together with our previous reports (10–13), our group revealed 34 patients with variants associated to monogenic diabetes (**Table 2**). Clinical characteristics of the patients with variants described by our group are presented in **Table 3**. None of the patients had any point variants in *KCNJ11*, *KLF11* and *INS* genes. Concerning the segregation study in the 34 relatives, 24 individuals showed the variant described in this study present in the probands. Among them, 20 individuals presented DM. Four relatives with variants in the *GCK* gene did not report DM at the moment of this study. Between the remaining 10 subjects not mutated, one related DM. Segregation analyses are shown in the **Figure 2**.

GCK-MODY (OMIM # 125851)

GCK screening showed 11 different variants in 13 probands: seven men and six women, AAD average of 12 ± 7.8 years, BMI average of 20.3 ± 1.8 kg/m², and HbA1c average of $6.5 \pm$

0.3%. At the time of the study, seven patients were in nutritional therapy only; three patients were in oral antidiabetic agents (OAD), and three on insulin therapy. Four patients had been clinically classified with T1DM, and three patients (23%) were diagnosed with possible GCK-MODY.

Among the variants identified in *GCK*, the p.(Phe423Tyr) (c.1268T>A) was found in three probands. Besides, two variants were novel, p.(Met115Val) (c.343A>G) and p.(Asp365Glu>Ter95) (c.1094_1095insGCGA); the variant p.(Met115Val) was reported in gnomAD (Frequency: 0.00001193), however, no phenotype characteristics were available. The *missense* p.(Met115Val) variant was observed in a female patient (P46) (**Figure 2, letter E**; individual III-3) diagnosed in her first pregnancy at the age of 25 years. This variant was observed segregating from her father (**Figure 2, letter E**; individual II-2) with diabetes and was found in her two brothers (**Figure 2, letter E**; individuals III-1 and III-2). The patient P55 (**Figure 2, letter G**; individual II-3), harboring the *frameshift* p.(Asp365Glu>Ter95) variant, was diagnosed at 26 years of age in a routine exam (BMI at diagnosis: 22.3 kg/m²). At the age of 32 years, when he entered in this study, he showed FPG varying from 109 to 128 mg/dL and HbA1c of 6.1% and he was controlling his hyperglycemia with diet. This variant was also observed in his father (**Figure 2, letter G**; individual I-1) diagnosed at 40 years of age and in his 5-year-old son (**Figure 2, letter G**; individual III-3), diagnosed at birth. His son was born prematurely, before 32 weeks of gestation. Both, the proband and his son, control their glycemic level with nutritional diet.

HNF1A-MODY (OMIM # 600496)

Among the 16 patients screened for *HNF1A*, four presented variants, one man and three women. The average of AAD was 24 ± 8.4 years, the mean BMI was 26.9 ± 2.7 kg/m², and

mean HbA1c of $7.3 \pm 0.3\%$. Concerning the treatment at the time of the study, one patient was using OAD, two were treated with insulin therapy, and one patient was using both treatments. Two patients had been clinically characterized with T2DM.

The screening of *HNF1A* revealed the p.(Arg271Trp) (c.811C>T) in two unrelated patients. Two novel variants, one *nonsense*, p.(Tyr163Ter) (c.489C>G), and one *frameshift*, p.(Val380CysfsTer39) (c.1136_1137insC), were identified. They were absent in gnomAD and ABraOM population databases. The p.(Val380CysfsTer39) *frameshift* variant was found in a patient (P56) diagnosed at 35 years of age, with a BMI at diagnostic of 28.2 kg/m². At the time of this study, at the age of 36 years (BMI: 25.3 kg/m²), she showed a FPG of 133 mg/dL and HbA1c of 6.9%, (TSH 0.73 mIU/L; Ft4 of 1.4 ng/dL). She has been treated with alogliptin (25 mg/day). Also, it was reported family members with DM: her father and her mother (AAD: 30 and 50 years, respectively), one brother (AAD: 40 years), two sisters (AAD: 32 and 36 years), two nieces and one nephew with AAD before the age of 25 years. The family members were not available to participate in our study.

The novel *nonsense* p.(Tyr163Ter) variant was observed segregating from the patient P52 (**Figure 2, letter K**; individual II-2) to her daughter (**Figure 2, letter K**; individual III-1). The patient AAD was 15 years of age presenting with polyuria, polydipsia and weight loss. Glyburide was initiated and she maintained good glycemic control for almost 26 years and at the age of 41 years, her treatment was switch for insulin (NPH and Regular) and Metformin XR (2000 g/day). At the time of this study, at the age of 49 years, she had a BMI of 25.8 kg/m², and HbA1c of 8.34%. She presented retinopathy and hypertension. The patient had continued the treatment with insulin (0.76 U/kg/day), and Metformin XR (2000 g/day) and

glicazide was started (60 mg/day). The patient's daughter was diagnosed at 15 years old and has been treated with glicazide (120 mg/day) and insulin (30 U/day).

HNF4A-MODY (OMIM # 125850)

A *nonsense* variant in the exon 4 of *HNF4A*, p.(Arg163Ter) (c.487C>T), was found in a woman (P23), the AAD was 19 years in a routine exam (BMI at diagnosis: 20 kg/m²) (**Figure 2, letter M**; individual II-2). At the age of 49 years, she presented a FPG of 294 mg/dL, managed with OAD (Glimepiride 4 mg/day) and, at the age of 53 years, she was initiated on insulin therapy. The variant segregated to her daughter (**Figure 2, letter M**; individual III-3), the AAD of 9 years old, with FPG of 125 mg/dL. The proband's daughter has 24 years of diagnosis and presents polyneuropathy, renal insufficiency and retinopathy, and has been treated with insulin therapy (10 U/day) with poor glycemic control. The proband's daughter gave birth to a baby (**Figure 2, letter M**; individual IV-1) with congenital heart malformation who died with three months of life, two miscarriage (**Figure 2, letter M**; individuals IV-2 and IV-4) and two live birth children (**Figure 2, letter M**; individuals IV-3 and IV-5). Her alive son (**Figure 2, letter M**; individual IV-5) was born with birth weight of 1.400 g and breathing problems. The children and their fathers were not available for testing. The younger proband's daughter (**Figure 2, letter M**; individual III-5) also presents DM, diagnosed at the age of 10 years old. However, she was not available for test.

HNF1B-MODY (OMIM # 137920)

The screening of the entire coding region of *HNF1B* showed a *nonsense* variant in the exon 4, p.(Arg276Ter) (c.826C>T). The patient (P65) is a woman of 19 years of age, clinically diagnosed with T1DM at 14 years old with symptoms of decompensated diabetes (at

diagnosis: FPG > 500 mg/dL; BMI 23.6 kg/m²). At the moment of this study, she presented a BMI of 21.9 kg/m², a HbA1c of 12.1%, and she was on insulin therapy (1.7 U/kg/day). The patient was initiated on insulin therapy since her diagnosis and presents no complications of DM; she reports nephrolithiasis. Furthermore, it was informed that her father, uncle and grandfather had DM, and both her uncle and grandfather deceased in young age from DM complications.

***MT-TL1* (OMIM * 590050)**

The variant m.3243A>G in the *MT-TL1* gene was identified in a male patient (P26) with clinical diagnosis of T1DM at 28 years (BMI at diagnosis: 21.9 kg/m²). At entry in the study, he was 30 years old, showing an HbA1c of 5.6%, FPG of 116 mg/dL (2-hour postprandial glucose: 145 mg/dL), plasmatic fasting insulin of 5.1 mcU/mL (postprandial insulin: 17.7 mcU/mL) and C-peptide of 2.1 ng/mL. He reported that his mother, father and eight siblings had DM. He did not show any sensorineural hearing loss. At the age of 37 years, he has been treated with insulin (0.12 U/kg/day) and glicazide (60 mg/day). His family was not available for testing.

Bioinformatics analysis

The 16 different variants identified in genomic DNA in this study and the 14 previous variants reported in our cohort (10–13) were evaluated through *in silico* predictions algorithms. With exception of the *missense HNF1A* p.(Gly31Asp), all nineteen *missense* variants were predicted as pathogenic at least for seven of nine programs used to predict the pathogenicity. Besides, they were predicted as conserved at least for three of four conservation predictions algorithms. The two *inframe GCK* p.(Lys39del) and p.(Phe150del)

variants were classified as pathogenic by SIFT, PolyPhen and VEST. The *frameshift* variants in *GCK* p.(Asp365GlufsTer95), *HNF1A* p.(Pro379ProfsTer) and p.(Thr433HisfsTer116), and *NEUROD1* p.(Phe256LeufsTer2) were evaluated only by SIFT and VEST and were classified as likely pathogenic. The four *nonsense* *HNF1A* p.(Tyr163Ter) and p.(Arg171Ter), *HNF4A* p.(Arg163Ter) and *HNF1B* p.(Arg276Ter) variants were classified as pathogenic at least for two of three algorithms analyzed and they were classified as conserved at least for three of four algorithms (**Table 4**). Since the *GCK* p.(Gly227Asp) is located in a splice site donor, we decided to analyze the impact of the change of glycine to aspartic acid in the position 227 of glucoquinase. According to the eight software analyzed, this variant did not have effect on splice, however, it may change the splicing site position (**Table 5**). According to the ACMG classification of pathogenicity, from the 30 variants in genomic DNA described by our group, 26 were characterized as pathogenic (17 variants) or likely pathogenic (9 variants), two were classified as uncertain significance, while the *PAX4* p.(Arg172Gln) was classified as likely benign and the *HNF1A* p.(Gly31Asp) was classified as benign (**Table 6**).

DISCUSSION

In this study, we screened fifty-seven Brazilian patients with clinical characteristics of monogenic diabetes. Patients were screened firstly for the *GCK* or *HNF1A* genes, according with their phenotypic manifestation, and then for *HNF4A*, *HNF1B*, *NEUROD1*, *KLF11*, *PAX4*, *INS*, *KCNJ11* and *MT-TL1*. Here, we observed 13 and 4 novel Brazilian cases of GCK-MODY and HNF1A-MODY, respectively. Taken these results together with our previous report, our group described 19 GCK-MODY cases and 9 HNF1A-MODY patients (10). Concerning the others MODY subtypes, we found one variant in each *HNF4A*, *HNF1B*, and *MT-TL1*. We had recently report variants in *NEUROD1* (12), *PAX4* (11), and *PDX1* (13) in

our cohort. Altogether, our results revealed the presence of variants in half of our cohort (34 of 68 patients) (**Table 1**).

Until now, variants in 14 genes have been recognized to cause monogenic diabetes type MODY, and variants on *GCK* and *HNF1A* represent the major cause worldwide. The frequency of each MODY subtype varies according to the recruitment criteria and the genetic background (6). In UK, variants in *HNF1A* were responsible for 52% of all MODY cases, followed by 32% of GCK-MODY (40). A retrospective database study of MODY cases reported in Brazil described the GCK-MODY as the most common form, followed by HNF1A-MODY (41). Depending on the genetic cause, each MODY subtype may present a different clinical profile, with variable age at onset, treatment response, and with some subtypes having a higher risk of long-term complications of DM, and extra pancreatic manifestations (42).

GCK-MODY patients present with mild fasting hyperglycemia from birth (43). Thus, the diagnosis is usually accidental and at any age (44). In our GCK-MODY cohort, the age at diagnosis ranged from 9 months to 32 years (**Table 3**) and the majority of the patients were diagnosed in routine exams. Misdiagnosis of GCK-MODY patients or misclassification as T1DM are frequent (45). However, the clinical presentation between these two forms is quite variable. Patients GCK-MODY show a milder hyperglycemia, higher C-peptide concentration (46), and the frequency of positivity of anti-GAD and anti-IA-2 antibodies in these patients is similar to those found in controls subjects (47). Among our 19 GCK-MODY patients, four were diagnosed in their childhood as having T1DM, and three of them have been treated with insulin therapy probably unnecessarily. Pharmacological management has no impact on glycaemia of GCK-MODY patients (outside pregnancy) (48). Besides the three probands

treated with insulin therapy, four patients had been treated with OAD at the moment of the study. After the molecular diagnostic, six patients stopped the pharmacological treatment and one patient was transferred for insulin to OAD along the study. Typically, patients with GCK-MODY with less than 40 years of age show an HbA1c ranging from 5.6 to 7.3% and a FPG range of 5.6 to 8.0 mmol/L (49). Our patients had the HbA1c (6-7.2%) and FPG (6.1-7.7 mmol/L) within these ranges.

The screening of the coding region of *GCK* revealed 17 different variants; six variants had already been reported by our group (p.(Tyr61Asp), p.(Phe150del), p.(Arg191Trp), p.(Gly227Asp), p.(Thr228Met) and p.(Ala384Val)) (10). The likely pathogenic missense variants p.(Arg36Trp), p.(Ala188Thr), p.(Arg191Trp), p.(Glu221Lys), p.(Ala384Val) and p.(Phe423Tyr) were also previously described in Brazilian probands (41,50–52). The p.(Phe423Tyr) was the only one to appear in more than one patient, it was found in three unrelated probands (P45, P58 and P63). In relation to the p.(Ala188Thr), this amino acid change seems to decrease glucokinase enzymatic activity, thermo-stability and lost the access to glucokinase regulatory protein (GRP) (53); the variant p.(Arg191Trp) is kinetically inactivating and the enzyme shows decrease in glucose and ATP affinity (54). To the best of our knowledge, this is the first report of the *GCK* p.(Arg43His), p.(Gly44Ser), p.(Thr209Arg), and p.(Pro359Leu) missense variants in Brazilian patients. We observed the first two segregating in their families (**Figure 2, letters C and D**). Unfortunately, the P59 (p.(Thr209Arg)) and P68 (p.(Pro359Leu)) proband's families were not available for being tested. We also found the previous reported *in frame* p.(Lys39del) variant (55). Among the 13 variants detected in the *GCK* in this study, two were novel, the *missense* p.(Met115Val) (c.343A>G) and the *frameshift* p.(Asp365Glu>Ter95) (c.1094_1095insGCGA). The p.(Met115Val) is registered in dbSNP under the number rs771677681 and is found in

gnomAD with an allele frequency of 0.00001193; however, this variant was not reported associated to diabetes in the databases. This variant was observed in the proband P46 (**Figure 2, letter E**; individual III-3) and in her two older brothers (**Figure 2, letter E**; individuals III-1 and III-2), inherited from their father with diabetes (**Figure 2, letter E**; individual II-2); the proband's middle brother (**Figure 2, letter E**; individual III-2) did not reported to have hyperglycemia, although his blood tests were not available. The p.(Asp365GlufsTer95) was observed segregating with DM through three generations (**Figure 2, letter G**).

Patients HNF1A-MODY present diabetes typically in adulthood due to a progressive insulin deficiency (56), with an increased risk of cardiovascular mortality similar to T1DM and T2DM (57). Variants in the *HNF1A* gene usually have high penetrance and the patients are usually diagnosed before the age of 40 years and rarely before 9 years of age (56,58). The age at diagnosis observed in our patients ranged from 12 to 35 years old (**Table 3**). Patients with hyperglycemia caused by *HNF1A* variant can remain sulfonylurea responsive for many years (59). The patient P37 has been treated with OAD (glimepiride 4 mg/day and metformin 2550 mg/day) after 19 years of the clinical diagnosis. Patients P44 and P56 were switched from insulin to OAD, after 15 years and 1 year since their diagnosis, respectively. However, some patients require insulin treatment, as is the case of the patients P4 and P52.

The screening of *HNF1A* showed eight different variants; five variants (p.(Gly31Asp), p.(Val133Glu), p.(Trp165Arg), p.(Arg171Ter) and p.(Thr433HisfsTer116)) had already been reported by our group (10). Here we describe the *HNF1A* p.(Arg271Trp) (c.811C>T), found in two unrelated patients (P44 and P70); this variant segregates among several individuals from the P44 proband's family (**Figure 2, letter L**). The P70 proband's family was not available. This variant seems to decrease the HNF1A affinity and binding to DNA (60,61).

Besides, we found a novel *nonsense* variant p.(Tyr163Ter) (c.489C>G), segregating from the patient P52 to her daughter with diabetes (**Figure 2, letter K**), both diagnosed at the age of 15 years old. Additionally, we found a novel *frameshift* variant p.(Val380CysfsTer39) (c.1136_1137insC) in the patient P56.

Although *HNF1A* p.(Gly31Asp) (c.92G>A), found in the patient P4, had been reported in previous studies associated to HNF1A-MODY (62,63), its pathogenicity is unclear, since it was found among non-DM controls (64) and it was the only variant reported here that was found on ABraOM (allele frequency: 0.000854). Unfortunately, the members from this family were not available for testing. Concerning the *nonsense* variant p.(Arg171Ter) (c.511C>T), identified in the proband P37, it was also reported in another Brazilian patient by Santana and coworkers (2017) (52). *In vitro* studies demonstrated that the premature codon terminal in the position 171 causes the loss of the homeodomain and transactivation domain, resulting in reduced DNA binding and consequently impaired transcriptional activation (61).

Variants in the *HNF4A* gene seem to be a rare cause of monogenic diabetes in Brazil (65). The *nonsense* variant p.(Arg163Ter) was described by Lindner and coworkers (1997) as the second variant found in the *HNF4A* associated to MODY in a family from German ancestry (66). The patients from the reported family were treated by OAD or insulin, and patients with longer time of the disease showed retinopathy and peripheral polyneuropathy (66). This variant was found in our study in the proband P23 (**Figure 2, letter M**; individual II-2), segregating to her daughter (**Figure 2, letter M**; individual III-3). The HNF4A works as a heterodimer and the premature stop codon results in a truncated protein that loses the transactivation domain (66,67) and the ability to form heterodimers (68). Besides, Laine and coworkers (2000) observed the *HNF4A* p.(Arg163Ter) with a dominant-negative effect (67).

In the patients from the German family reported by Lindner and coworkers (1997) was noticed coronary heart disease and no nephropathy (66), while in our study, in the Brazilian family, was reported renal insufficiency and no heart disease. Besides, the proband's daughter (**Figure 2, letter M**; individual III-3) presented peripheral polyneuropathy.

The *nonsense HNF1B* p.(Arg276Ter) was described in two Japanese patients with small kidneys and multiple renal cysts (69,70). Renal ultrasound from our patient was not available, however a review of her medical chart revealed nephrolithiasis.

In this study, we also described one male patient with diabetes (P26), referred to *HNF1A* test, carrying the *MT-TL1* m.3243A>G variant. The patient did not present any other clinical manifestations of MIDD, as sensorineural hearing loss. It has been described a wide spectrum of clinical variability for *MT-TL1* m.3243A>G variant, ranging from asymptomatic carriers to lethal multisystem disorders (71). These finds highlights the importance of screening this genetic variant in patients with familiar recurrence of diabetes despite the lack of other clinical characteristics related to MIDD and MELAS syndrome.

We reported in the present study 20 Brazilian patients with clinical characteristics of diabetes and autosomal dominant inheritance with variants in genes associated to monogenic forms of DM. This study has some limitations worth noting: 1) The sample size is small; 2) The segregation analysis of *HNF1A* p.(Val380CysfsTer39) and p.(Val133Glu), and *GCK* p.(Met115Val) was not possible; 3) We did not analyze other genes associated to monogenic diabetes; and 4) We did not performed analysis for detection of large duplications and deletions.

Here we highlight the importance of screening for monogenic forms of diabetes in patients with familial history of diabetes. Giving an accurate diagnostic with molecular confirmation of monogenic diabetes, the results obtained could improve the choice of the best therapeutic management of patients and their families and long-term clinical evolution.

CONFLICT OF INTEREST

All authors declare that are no conflicts of interest regarding this work.

ACKNOWLEDGMENTS

The authors are grateful to the patients and their families and to the DNA Sequencing Platform (RPT01A) from Oswaldo Cruz Institute. The National Council for Scientific and Technological Development (CNPq), Coordination for the Improvement of Higher Education Personnel (CAPES), Carlos Chagas Filho Foundation for Research Support of the State of Rio de Janeiro (FAPERJ) and Oswaldo Cruz Institute (IOC) supported this work.

References

1. Harris AG, Letourneau LR, Greeley SAW. Monogenic diabetes: the Impact of Making the Right Diagnosis. *Curr Opin Pediatr* [Internet]. 2018 Aug;30(4):558–67. Available from: <http://journals.lww.com/00008480-201808000-00019>
2. De Franco E, Flanagan SE, Houghton JAL, Allen HL, MacKay DJG, Temple IK, et al. The effect of early, comprehensive genomic testing on clinical care in neonatal diabetes: An international cohort study. *Lancet* [Internet]. 2015;386(9997):957–63. Available from: [http://dx.doi.org/10.1016/S0140-6736\(15\)60098-8](http://dx.doi.org/10.1016/S0140-6736(15)60098-8)
3. American Diabetes Association. Diagnosis and Classification of Diabetes Mellitus. *Diabetes Care* [Internet]. 2014 Jan 1;37(Supplement_1):S81–90. Available from: <http://care.diabetesjournals.org/cgi/doi/10.2337/dc14-S081>
4. Nesbitt V, Pitceathly RDS, Turnbull DM, Taylor RW, Sweeney MG, Mudanohwo EE, et al. The UK MRC Mitochondrial Disease Patient Cohort Study: clinical phenotypes associated with the m.3243A>G mutation--implications for diagnosis and management. *J Neurol Neurosurg Psychiatry* [Internet]. 2013 Aug 1;84(8):936–8. Available from: <http://jnnp.bmj.com/cgi/doi/10.1136/jnnp-2012-303528>
5. Tattersall RB. Mild familial diabetes with dominant inheritance. *Quartely J Med* [Internet]. 1974;43(2):339–57. Available from: <http://jnnp.bmj.com/cgi/doi/10.1136/jnnp-2012-303528>
6. Firdous P, Nissar K, Ali S, Ganai BA, Shabir U, Hassan T, et al. Genetic Testing of Maturity-Onset Diabetes of the Young Current Status and Future Perspectives. *Front Endocrinol (Lausanne)* [Internet]. 2018 May 17;9(MAY):1–13. Available from: <http://journal.frontiersin.org/article/10.3389/fendo.2018.00253/full>
7. Aidar M, Line SRP. A simple and cost-effective protocol for DNA isolation from

buccal epithelial cells. *Braz Dent J* [Internet]. 2007 Feb;18(2):148–52. Available from: <http://link.springer.com/10.1007/BF01811861>

8. Naslavsky MS, Yamamoto GL, de Almeida TF, Ezquina SAM, Sunaga DY, Pho N, et al. Exomic variants of an elderly cohort of Brazilians in the ABraOM database. *Hum Mutat* [Internet]. 2017 Jul;38(7):751–63. Available from: <http://doi.wiley.com/10.1002/humu.23220>

9. Kopanos C, Tsiolkas V, Kouris A, Chapple CE, Albarca Aguilera M, Meyer R, et al. VarSome: the human genomic variant search engine. Wren J, editor. *Bioinformatics* [Internet]. 2019 Jun 1;35(11):1978–80. Available from: <https://academic.oup.com/bioinformatics/article/35/11/1978/5146783>

10. Tarantino RM, Abreu G de M, Fonseca ACP de, Kupfer R, Pereira M de FC, Campos M, et al. MODY probability calculator for GCK and HNF1A screening in a multiethnic background population. *Arch Endocrinol Metab* [Internet]. 2019 Sep 25;1(8):1–7. Available from: http://www.scielo.br/scielo.php?script=sci_arttext&pid=S2359-39972019005008101&lng=en&nrm=iso

11. de Medeiros Abreu G, de Almeida Pereira Dias Soares C, Magalhães Tarantino R, Proença da Fonseca AC, Bastos de Souza R, Carvalho Pereira M de F, et al. Identification of the First PAX4-MODY Family Reported in Brazil. *Diabetes, Metab Syndr Obes Targets Ther* [Internet]. 2020 Jul;13:2623–31. Available from: <https://www.dovepress.com/identification-of-the-first-pax4-mody-family-reported-in-brazil-peer-reviewed-article-DMSO>

12. Abreu G de M, Tarantino RM, Cabello PH, Zembrzuski VM, Fonseca ACP, Rodacki M, et al. The first case of NEUROD1-MODY reported in Latin America. *Mol Genet Genomic Med* [Internet]. 2019 Dec 2;7(12):1–6. Available from: <https://onlinelibrary.wiley.com/doi/abs/10.1002/mgg3.989>

13. Abreu GDM, Tarantino RM, da Fonseca ACP, de Souza RB, Soares CAPD, Cabello

PH, et al. PDX1-MODY: A rare missense mutation as a cause of monogenic diabetes. *Eur J Med Genet* [Internet]. 2021 May;64(5):104194. Available from: <https://linkinghub.elsevier.com/retrieve/pii/S1769721221000604>

14. Pejaver V, Urresti J, Lugo-Martinez J, Pagel KA, Lin GN, Nam H-J, et al. Inferring the molecular and phenotypic impact of amino acid variants with MutPred2. *Nat Commun* [Internet]. 2020 Dec 20;11(1):5918. Available from: <http://mutpred.mutdb.org/>

15. Shihab HA, Gough J, Cooper DN, Stenson PD, Barker GLA, Edwards KJ, et al. Predicting the Functional, Molecular, and Phenotypic Consequences of Amino Acid Substitutions using Hidden Markov Models. *Hum Mutat* [Internet]. 2013 Jan;34(1):57–65. Available from: <http://doi.wiley.com/10.1002/humu.22225>

16. Carter H, Douville C, Stenson PD, Cooper DN, Karchin R. Identifying Mendelian disease genes with the Variant Effect Scoring Tool. *BMC Genomics* [Internet]. 2013;14(Suppl 3):S3. Available from: <http://www.biomedcentral.com/1471-2164/14/S3/S3>

17. Douville C, Masica DL, Stenson PD, Cooper DN, Gygax DM, Kim R, et al. Assessing the Pathogenicity of Insertion and Deletion Variants with the Variant Effect Scoring Tool (VEST-Indel). *Hum Mutat* [Internet]. 2016 Jan 26;37(1):28–35. Available from: <https://onlinelibrary.wiley.com/doi/10.1002/humu.22911>

18. Sim N-L, Kumar P, Hu J, Henikoff S, Schneider G, Ng PC. SIFT web server: predicting effects of amino acid substitutions on proteins. *Nucleic Acids Res* [Internet]. 2012 Jul 1;40(W1):W452–7. Available from: <https://academic.oup.com/nar/article-lookup/doi/10.1093/nar/gks539>

19. Adzhubei IA, Schmidt S, Peshkin L, Ramensky VE, Gerasimova A, Bork P, et al. A method and server for predicting damaging missense mutations. *Nat Methods* [Internet]. 2010 Apr;7(4):248–9. Available from: <http://www.nature.com/articles/nmeth0410-248>

20. Schwarz JM, Cooper DN, Schuelke M, Seelow D. MutationTaster2: mutation prediction for the deep-sequencing age. *Nat Methods* [Internet]. 2014 Apr 28;11(4):361–2. Available from: <http://dx.doi.org/10.1038/nmeth.2890>
21. Choi Y, Chan AP. PROVEAN web server: a tool to predict the functional effect of amino acid substitutions and indels. *Bioinformatics* [Internet]. 2015 Aug 15;31(16):2745–7. Available from: <https://academic.oup.com/bioinformatics/article-lookup/doi/10.1093/bioinformatics/btv195>
22. Reva B, Antipin Y, Sander C. Predicting the functional impact of protein mutations: application to cancer genomics. *Nucleic Acids Res* [Internet]. 2011 Sep;39(17):e118–e118. Available from: <https://academic.oup.com/nar/article-lookup/doi/10.1093/nar/gkr407>
23. Chun S, Fay JC. Identification of deleterious mutations within three human genomes. *Genome Res* [Internet]. 2009 Sep 1;19(9):1553–61. Available from: <http://genome.cshlp.org/cgi/doi/10.1101/gr.092619.109>
24. Davydov E V., Goode DL, Sirota M, Cooper GM, Sidow A, Batzoglou S. Identifying a High Fraction of the Human Genome to be under Selective Constraint Using GERP++. Wasserman WW, editor. *PLoS Comput Biol* [Internet]. 2010 Dec 2;6(12):e1001025. Available from: <https://dx.plos.org/10.1371/journal.pcbi.1001025>
25. Garber M, Guttman M, Clamp M, Zody MC, Friedman N, Xie X. Identifying novel constrained elements by exploiting biased substitution patterns. *Bioinformatics* [Internet]. 2009 Jun 15;25(12):i54–62. Available from: <https://academic.oup.com/bioinformatics/article-lookup/doi/10.1093/bioinformatics/btp190>
26. Ramani R, Krumholz K, Huang Y-F, Siepel A. PhastWeb: a web interface for evolutionary conservation scoring of multiple sequence alignments using phastCons and phyloP. Schwartz R, editor. *Bioinformatics* [Internet]. 2019 Jul 1;35(13):2320–2. Available

from: <https://academic.oup.com/bioinformatics/article/35/13/2320/5210871>

27. Ioannidis NM, Rothstein JH, Pejaver V, Middha S, McDonnell SK, Baheti S, et al. REVEL: An Ensemble Method for Predicting the Pathogenicity of Rare Missense Variants. *Am J Hum Genet* [Internet]. 2016 Oct;99(4):877–85. Available from: <http://dx.doi.org/10.1016/j.ajhg.2016.08.016>
28. McLaren W, Gil L, Hunt SE, Riat HS, Ritchie GRS, Thormann A, et al. The Ensembl Variant Effect Predictor. *Genome Biol* [Internet]. 2016 Dec 6;17(1):122. Available from: <http://dx.doi.org/10.1186/s13059-016-0974-4>
29. Liu X, Jian X, Boerwinkle E. dbNSFP: A lightweight database of human nonsynonymous SNPs and their functional predictions. *Hum Mutat* [Internet]. 2011 Aug 26;32(8):894–9. Available from: <https://onlinelibrary.wiley.com/doi/10.1002/humu.21517>
30. Liu X, Li C, Mou C, Dong Y, Tu Y. dbNSFP v4: a comprehensive database of transcript-specific functional predictions and annotations for human nonsynonymous and splice-site SNVs. *Genome Med* [Internet]. 2020 Dec 2;12(1):103. Available from: <https://genomemedicine.biomedcentral.com/articles/10.1186/s13073-020-00803-9>
31. Culp M, Johnson K, Michailidis G. *ada*: An R Package for Stochastic Boosting. *J Stat Softw* [Internet]. 2006;17(2):1–27. Available from: <http://www.jstatsoft.org/v17/i02/>
32. Liaw A, Wiener M. Classification and Regression by randomForest. *R news* [Internet]. 2002;2(December):18–22. Available from: <http://cran.r-project.org/doc/Rnews/>
33. Yeo G, Burge CB. Maximum Entropy Modeling of Short Sequence Motifs with Applications to RNA Splicing Signals. *J Comput Biol* [Internet]. 2004 Mar;11(2–3):377–94. Available from: <http://www.liebertpub.com/doi/10.1089/1066527041410418>
34. Jian X, Boerwinkle E, Liu X. In silico prediction of splice-altering single nucleotide variants in the human genome. *Nucleic Acids Res* [Internet]. 2014 Dec 16;42(22):13534–44.

Available from: <http://academic.oup.com/nar/article/42/22/13534/2411339/In-silico-prediction-of-splicealtering-single>

35. Brunak S, Engelbrecht J, Knudsen S. Prediction of human mRNA donor and acceptor sites from the DNA sequence. *J Mol Biol* [Internet]. 1991 Jul;220(1):49–65. Available from: <https://linkinghub.elsevier.com/retrieve/pii/0022283691903800>
36. Hebsgaard SM, Korning PG, Tolstrup N, Engelbrecht J, Rouzé P, Brunak S. Splice site prediction in *Arabidopsis thaliana* pre-mRNA by combining local and global sequence information. *Nucleic Acids Res* [Internet]. 1996 Sep 1;24(17):3439–52. Available from: <https://academic.oup.com/nar/article-lookup/doi/10.1093/nar/24.17.3439>
37. Krogh A. Two methods for improving performance of an HMM and their application for gene finding. *Proceedings Int Conf Intell Syst Mol Biol* [Internet]. 1997;5:179–86. Available from: <http://www.ncbi.nlm.nih.gov/pubmed/9322033>
38. Reese MG, Eeckman FH, Kulp D, Haussler D. Improved splice site detection in Genie. *J Comput Biol* [Internet]. 1997 Jan;4(3):311–23. Available from: <http://www.liebertpub.com/doi/10.1089/cmb.1997.4.311>
39. Desmet F-O, Hamroun D, Lalande M, Collod-Bérout G, Claustres M, Bérout C. Human Splicing Finder: an online bioinformatics tool to predict splicing signals. *Nucleic Acids Res* [Internet]. 2009 May;37(9):e67–e67. Available from: <https://academic.oup.com/nar/article-lookup/doi/10.1093/nar/gkp215>
40. Shields BM, Hicks S, Shepherd MH, Colclough K, Hattersley AT, Ellard S. Maturity-onset diabetes of the young (MODY): how many cases are we missing? *Diabetologia* [Internet]. 2010 Dec 25;53(12):2504–8. Available from: <http://link.springer.com/10.1007/s00125-010-1799-4>
41. Giuffrida FMA, Moises RS, Weinert LS, Calliari LE, Manna T Della, Dotto RP, et al.

- Maturity-onset diabetes of the young (MODY) in Brazil: Establishment of a national registry and appraisal of available genetic and clinical data. *Diabetes Res Clin Pract* [Internet]. 2017;123:134–42. Available from: <http://linkinghub.elsevier.com/retrieve/pii/S016882271630376X%5Cnhttp://www.ncbi.nlm.nih.gov/pubmed/28012402>
42. Vaxillaire M, Froguel P. Monogenic diabetes: Implementation of translational genomic research towards precision medicine. *J Diabetes* [Internet]. 2016 Nov;8(6):782–95. Available from: <http://doi.wiley.com/10.1111/1753-0407.12446>
43. Prisco F, Iafusco D, Franzese A, Sulli N, Barbetti F. MODY 2 presenting as neonatal hyperglycaemia: a need to reshape the definition of “neonatal diabetes”? *Diabetologia* [Internet]. 2000 Oct 2;43(10):1331–2. Available from: <http://link.springer.com/10.1007/s001250051531>
44. Chakera AJ, Steele AM, Gloyn AL, Shepherd MH, Shields B, Ellard S, et al. Recognition and management of individuals with hyperglycemia because of a heterozygous glucokinase mutation. *Diabetes Care*. 2015;38(7):1383–92.
45. Petruzelkova L, Dusatkova P, Cinek O, Sumnik Z, Pruhova S, Hradsky O, et al. Substantial proportion of MODY among multiplex families participating in a Type 1 diabetes prediction programme. *Diabet Med* [Internet]. 2016 Dec;33(12):1712–6. Available from: <http://doi.wiley.com/10.1111/dme.13043>
46. Fu J, Wang T, Liu J, Wang X, Zhang Q, Li M, et al. Using Clinical Indices to Distinguish MODY2 (GCK Mutation) and MODY3 (HNF1A Mutation) from Type 1 Diabetes in a Young Chinese Population. *Diabetes Ther* [Internet]. 2019;10(4):1381–90. Available from: <https://doi.org/10.1007/s13300-019-0647-x>
47. McDonald TJ, Colclough K, Brown R, Shields B, Shepherd M, Bingley P, et al. Islet

autoantibodies can discriminate maturity-onset diabetes of the young (MODY) from Type 1 diabetes. *Diabet Med*. 2011;28(9):1028–33.

48. Stride A, Shields B, Gill-Carey O, Chakera AJ, Colclough K, Ellard S, et al. Cross-sectional and longitudinal studies suggest pharmacological treatment used in patients with glucokinase mutations does not alter glycaemia. *Diabetologia* [Internet]. 2014 Jan 4;57(1):54–6. Available from: <http://link.springer.com/10.1007/s00125-013-3075-x>

49. Steele AM, Wensley KJ, Ellard S, Murphy R, Shepherd M, Colclough K, et al. Use of HbA1c in the Identification of Patients with Hyperglycaemia Caused by a Glucokinase Mutation: Observational Case Control Studies. Lin X (Erick), editor. *PLoS One* [Internet]. 2013 Jun 14;8(6):e65326. Available from: <https://dx.plos.org/10.1371/journal.pone.0065326>

50. Caetano LA, Jorge AAL, Malaquias AC, Trarbach EB, Queiroz MS, Nery M, et al. Incidental mild hyperglycemia in children : two MODY 2 families identified in Brazilian subjects. *Arq Bras Endocrinol Metabol* [Internet]. 2012;56(8):519–24. Available from: https://www.scielo.br/scielo.php?script=sci_arttext&pid=S0004-27302012000800010

51. Giuffrida FMA, Calliari LE, Manna T Della, Ferreira JG, Saddi-Rosa P, Kunii IS, et al. A novel glucokinase deletion (p.Lys32del) and five previously described mutations co-segregate with the phenotype of mild familial hyperglycaemia (MODY2) in Brazilian families. *Diabetes Res Clin Pract* [Internet]. 2013;100(2):e42–5. Available from: [https://www.diabetesresearchclinicalpractice.com/article/S0168-8227\(13\)00030-2/fulltext](https://www.diabetesresearchclinicalpractice.com/article/S0168-8227(13)00030-2/fulltext)

52. Santana LS, Caetano LA, Costa-Riquetto AD, Quedas EPS, Nery M, Collett-Solberg P, et al. Clinical application of ACMG-AMP guidelines in HNF1A and GCK variants in a cohort of MODY families. *Clin Genet* [Internet]. 2017;92(4):388–96. Available from: <https://onlinelibrary.wiley.com/doi/abs/10.1111/cge.12988>

53. Liu L, Liu Y, Ge X, Liu X, Chen C, Wang Y, et al. Insights into pathogenesis of five

novel GCK mutations identified in Chinese MODY patients. *Metabolism* [Internet]. 2018;89:8–17. Available from: <https://doi.org/10.1016/j.metabol.2018.09.004>

54. Wang Z, Diao C, Liu Y, Li M, Zheng J, Zhang Q, et al. Identification and functional analysis of GCK gene mutations in 12 Chinese families with hyperglycemia. *J Diabetes Investig* [Internet]. 2019 Jul;10(4):963–71. Available from: <https://onlinelibrary.wiley.com/doi/abs/10.1111/jdi.13001?af=R>

55. Zubkova NA, Gioeva OA, Tikhonovich Y V., Petrov VM, Vasilyev E V., Timofeev A V., et al. Clinical and molecular genetic characteristics of MODY1—3 cases in the Russian Federation as shown by NGS. *Probl Endocrinol* [Internet]. 2018 Feb 11;63(6):369–78. Available from: <https://probl-endojournals.ru/probl/article/view/8165>

56. Frayling TM, Bulman M, Ellard S, Appeton M, Dronsfield MJ, Mackie ADR, et al. Mutations in hepatocyte nuclear factor 1beta are not a common cause of maturity-onset diabetes of the young in the U.K. *Diabetes* [Internet]. 1998 Jul 1;47(7):1152–4. Available from: <http://diabetes.diabetesjournals.org/cgi/doi/10.2337/diabetes.47.7.1152>

57. Steele AM, Shields BM, Shepherd M, Ellard S, Hattersley AT, Pearson ER. Increased all-cause and cardiovascular mortality in monogenic diabetes as a result of mutations in the HNF1A gene. *Diabet Med* [Internet]. 2010 Feb;27(2):157–61. Available from: <http://doi.wiley.com/10.1111/j.1464-5491.2009.02913.x>

58. Yorifuji T, Fujimaru R, Hosokawa Y, Tamagawa N, Shiozaki M, Aizu K, et al. Comprehensive molecular analysis of Japanese patients with pediatric-onset MODY-type diabetes mellitus. *Pediatr Diabetes* [Internet]. 2012;13(1):26–32. Available from: <https://onlinelibrary.wiley.com/doi/abs/10.1111/j.1399-5448.2011.00827.x>

59. Fajans SS, Brown MB. Administration of Sulfonylureas Can Increase Glucose-Induced Insulin Secretion for Decades in Patients With Maturity-Onset Diabetes of the

Young. *Diabetes Care* [Internet]. 1993 Sep 1;16(9):1254–61. Available from:

<http://care.diabetesjournals.org/cgi/doi/10.2337/diacare.16.9.1254>

60. Galan M, Garcia-Herrero C-M, Azriel S, Gargallo M, Durán M, Gorgojo J-J, et al.

Differential Effects of HNF-1 α Mutations Associated with Familial Young-Onset Diabetes on Target Gene Regulation. *Mol Med* [Internet]. 2011;17(3–4):256–65. Available from:

http://www.molmed.org/content/pdfstore/10_133_Lu.pdf

61. Bjørkhaug L, Sagen J V., Thorsby P, Sjøvik O, Molven A, Njølstad PR. Hepatocyte

nuclear factor-1 α gene mutations and diabetes in Norway. *J Clin Endocrinol Metab* [Internet].

2003;88(2):920–31. Available from: <https://academic.oup.com/jcem/article/88/2/920/2845405>

62. Chèvre J-C, Hani EH, Boutin P, Vaxillaire M, Blanché H, Vionnet N, et al. Mutation

screening in 18 Caucasian families suggest the existence of other MODY genes. *Diabetologia*

[Internet]. 1998 Aug 19;41(9):1017–23. Available from:

<http://link.springer.com/10.1007/s001250051025>

63. Beijers HJBH, Losekoot M, Odink RJ, Bravenboer B. Hepatocyte nuclear factor

(HNF)1A and HNF4A substitution occurring simultaneously in a family with maturity-onset diabetes of the young. *Diabet Med* [Internet]. 2009;26(11):1172–4. Available from:

<https://onlinelibrary.wiley.com/doi/abs/10.1111/j.1464-5491.2009.02855.x>

64. Najmi LA, Aukrust I, Flannick J, Molnes J, Burt N, Molven A, et al. Functional

investigations of HNF1A identify rare variants as risk factors for type 2 diabetes in the general population. *Diabetes* [Internet]. 2017;66(2):335–46. Available from:

<https://diabetes.diabetesjournals.org/content/66/2/335>

65. Santana LS, Caetano LA, Costa-Riquetto AD, Franco PC, Dotto RP, Reis AF, et al.

Targeted sequencing identifies novel variants in common and rare MODY genes. *Mol Genet Genomic Med* [Internet]. 2019 Dec 8;7(12):1–17. Available from:

<https://onlinelibrary.wiley.com/doi/abs/10.1002/mgg3.962>

66. Lindner T, Gragnoli C, Furuta H, Cockburn BN, Petzold C, Rietzsch H, et al. Hepatic function in a family with a nonsense mutation (R154X) in the hepatocyte nuclear factor-4 α /MODY1 gene. *J Clin Invest* [Internet]. 1997 Sep 15;100(6):1400–5. Available from: <http://www.jci.org/articles/view/119660>
67. Laine B, Eeckhoutte J, Suaud L, Briche I, Furuta H, Bell GI, et al. Functional properties of the R154X HNF-4 α protein generated by a mutation associated with maturity-onset diabetes of the young, type 1. *FEBS Lett*. 2000;479(1–2):41–5.
68. Ogata M, Awaji T, Iwasaki N, Fujimaki R, Takizawa M, Maruyama K, et al. Localization of hepatocyte nuclear factor-4 α in the nucleolus and nucleus is regulated by its C-terminus. *J Diabetes Investig*. 2012;3(5):449–56.
69. Furuta H, Furuta M, Sanke T, Ekawa K, Hanabusa T, Nishi M, et al. Nonsense and Missense Mutations in the Human Hepatocyte Nuclear Factor-1 β Gene (TCF2) and Their Relation to Type 2 Diabetes in Japanese. *J Clin Endocrinol Metab* [Internet]. 2002 Aug;87(8):3859–63. Available from: <https://academic.oup.com/jcem/article-lookup/doi/10.1210/jcem.87.8.8776>
70. Fujimoto K, Sasaki T, Hiki Y, Nemoto M, Utsunomiya Y, Yokoo T, et al. In vitro and pathological investigations of MODY5 with the R276X-HNF1 β (TCF2) mutation. *Endocr J* [Internet]. 2007;54(5):757–64. Available from: https://www.jstage.jst.go.jp/article/endocrj/54/5/54_K07-051/_article
71. Mancuso M, Orsucci D, Angelini C, Bertini E, Carelli V, Comi G Pietro, et al. The m.3243A>G mitochondrial DNA mutation and related phenotypes. A matter of gender? *J Neurol* [Internet]. 2014 Mar 29;261(3):504–10. Available from: <http://link.springer.com/10.1007/s00415-013-7225-3>

72. Hager J, Blanché H, Sun F, Vaxillaire NVM, Poller W, Cohen D, et al. Six mutations in the glucokinase gene identified in MODY by using a nonradioactive sensitive screening technique. *Diabetes* [Internet]. 1994;43(5):730–3. Available from: <https://europepmc.org/article/med/8168652>
73. Ziemssen F, Bellanné-Chantelot C, Osterhoff M, Schatz H, Pfeiffer AFH. - to: Lindner T, Cockburn BN, Bell GI (1999) Molecular genetics of MODY in Germany. *Diabetologia* 42: 121–123. *Diabetologia* [Internet]. 2002 Feb;45(2):286–7. Available from: <http://link.springer.com/10.1007/s00125-001-0738-9>
74. Gragnoli C, Cockburn BN, Chiaramonte F, Gorini A, Marietti G, Marozzi G, et al. Early-onset Type II diabetes mellitus in Italian families due to mutations in the genes encoding hepatic nuclear factor 1 α and glucokinase. *Diabetologia* [Internet]. 2001 Oct 1;44(10):1326–9. Available from: <http://link.springer.com/10.1007/s001250100644>
75. Massa O, Meschi F, Cuesta-Munoz A, Caumo A, Cerutti F, Toni S, et al. High prevalence of glucokinase mutations in Italian children with MODY. Influence on glucose tolerance, first-phase insulin response, insulin sensitivity and BMI. *Diabetologia* [Internet]. 2001 Jul 1;44(7):898–905. Available from: <http://link.springer.com/10.1007/s001250100530>
76. Takeda J, Gidh-jain M, Xu LZ, Froguel P, Velho G, Vaxillaire M, et al. Structure/Function Studies of Human Beta-Cell Glucokinase. Enzymatic Properties of a Sequence Polymorphism, Mutations Associated With Diabetes, and Other Site-Directed Mutants. *J Biol Chem* [Internet]. 1993;268(20):15200–4. Available from: [https://www.jbc.org/article/S0021-9258\(18\)82456-5/pdf](https://www.jbc.org/article/S0021-9258(18)82456-5/pdf)
77. Ellard S, Beards F, Allen LIS, Shepherd M, Ballantyne E, Harvey R, et al. A high prevalence of glucokinase mutations in gestational diabetic subjects selected by clinical criteria. *Diabetologia* [Internet]. 2000 Feb 8;43(2):250–3. Available from: <http://link.springer.com/10.1007/s001250050038>

78. Borowiec M, Fendler W, Antosik K, Baranowska A, Gnys P, Zmyslowska A, et al. Doubling the referral rate of monogenic diabetes through a nationwide information campaign - update on glucokinase gene mutations in a Polish cohort. *Clin Genet* [Internet]. 2012 Dec;82(6):587–90. Available from: <http://doi.wiley.com/10.1111/j.1399-0004.2011.01803.x>
79. Guazzini B, Gaffi D, Mainieri D, Multari G, Cordera R, Bertolini S, et al. Three novel missense mutations in the glucokinase gene (G80S; E221K; G227C) in Italian subjects with maturity-onset diabetes of the young (MODY). *Hum Mutat* [Internet]. 1998;12(2):136–136. Available from: <http://doi.wiley.com/10.1002/%28SICI%291098-1004%281998%2912%3A2%3C136%3A%3AAID-HUMU13%3E3.3.CO%3B2-M>
80. Dominguez-Lopez M, Fernandez-Arias JD, Gonzalez-Molero I, Valdes S, Miguel G-ZJ, Guerrero M, et al. Clinical experience of a monogenic diabetes unit during 2008--2012 in the Department of Endocrinology and Nutrition (Malaga, Spain). *Endocr Abstr* [Internet]. 2013 Apr 1;2:P366. Available from: <http://www.endocrine-abstracts.org/ea/0032/ea0032P366.htm>
81. Stoffel M, Froguel P, Takeda J, Zouali H, Vionnet N, Nishi S, et al. Human glucokinase gene: isolation, characterization, and identification of two missense mutations linked to early-onset non-insulin-dependent (type 2) diabetes mellitus. *Proc Natl Acad Sci* [Internet]. 1992 Aug 15;89(16):7698–702. Available from: <http://www.pnas.org/content/pnas/89/16/7698.full.pdf>
82. Garin I, Rica I, Estalella I, Oyarzabal M, Rodríguez-Rigual M, Pedro JIS, et al. Haploinsufficiency at GCK gene is not a frequent event in MODY2 patients. *Clin Endocrinol (Oxf)* [Internet]. 2008 Jun;68(6):873–8. Available from: <http://doi.wiley.com/10.1111/j.1365-2265.2008.03214.x>
83. Costantini S, Malerba G, Contreas G, Corradi M, Marin Vargas SP, Giorgetti A, et al. Genetic and bioinformatics analysis of four novel GCK missense variants detected in

Caucasian families with GCK-MODY phenotype. *Clin Genet* [Internet]. 2015

May;87(5):440–7. Available from: <http://doi.wiley.com/10.1111/cge.12406>

84. Almeida C, Silva SR, Garcia E, Leite AL, Teles A, Campos RA. A novel genetic mutation in a Portuguese family with GCK-MODY. *J Pediatr Endocrinol Metab* [Internet].

2014 Jan 1;27(1–2):129–33. Available from:

<https://www.degruyter.com/view/j/jpem.2014.27.issue-1-2/jpem-2013-0056/jpem-2013-0056.xml>

85. Tatsi C, Kanaka-Gantenbein C, Vazeou-Gerassimidi A, Chrysis D, Delis D, Tentolouris N, et al. The spectrum of HNF1A gene mutations in Greek patients with MODY3: relative frequency and identification of seven novel germline mutations. *Pediatr Diabetes* [Internet]. 2013 Nov;14(7):526–34. Available from:

<http://doi.wiley.com/10.1111/pedi.12032>

86. Vaxillaire M, Rouard M, Yamagata K, Oda N, Kaisaki P, Boriraj V, et al.

Identification of nine novel mutations in the hepatocyte nuclear factor 1 alpha gene associated with maturity-onset diabetes of the young (MODY3). *Hum Mol Genet* [Internet]. 1997 Apr 1;6(4):583–6. Available from: <https://academic.oup.com/hmg/article-lookup/doi/10.1093/hmg/6.4.583>

87. Plengvidhya N, Kooptiwut S, Songtawee N, Doi A, Furuta H, Nishi M, et al. PAX4 Mutations in Thais with Maturity Onset Diabetes of the Young. *J Clin Endocrinol Metab* [Internet]. 2007 Jul;92(7):2821–6. Available from: <https://academic.oup.com/jcem/article-lookup/doi/10.1210/jc.2006-1927>

88. Schwitzgebel VM, Mamin A, Brun T, Ritz-Laser B, Zaiko M, Maret A, et al. Agenesis of Human Pancreas due to Decreased Half-Life of Insulin Promoter Factor 1. *J Clin Endocrinol Metab* [Internet]. 2003 Sep;88(9):4398–406. Available from:

<https://academic.oup.com/jcem/article-lookup/doi/10.1210/jc.2003-030046>

89. Goto Y, Nonaka I, Horai S. A mutation in the tRNA^{Leu}(UUR) gene associated with the MELAS subgroup of mitochondrial encephalomyopathies. *Nature* [Internet]. 1990 Dec;348(6302):651–3. Available from: <http://www.nature.com/articles/348651a0>
90. Dong C, Wei P, Jian X, Gibbs R, Boerwinkle E, Wang K, et al. Comparison and integration of deleteriousness prediction methods for nonsynonymous SNVs in whole exome sequencing studies. *Hum Mol Genet* [Internet]. 2015 Apr 15;24(8):2125–37. Available from: <https://academic.oup.com/hmg/article-lookup/doi/10.1093/hmg/ddu733>

Table 1. Explanation of the sample screening by our group

Gene	N° of patients studied	Patients with mutation	Patients without mutation	N° of patients analyzed	References
<i>GCK</i>	7	6	1	34	(10)
<i>HNF1A</i>	27	5	22		
<i>GCK</i>	19	13	6	35	This study
<i>HNF1A</i>	16	4	12		
Total:	69	28	41	69	
Excluded from further analysis:		28	1*		
Total after exclusion:			40		
<i>NEUROD1</i>	25	1	24	40	(12)
	15	0	0		This study
<i>PAX4</i>	31	1	30	40	(11)
	9	0	9		This study
<i>PDX1</i>	43#	1	42	43	(13)
<i>HNF4A</i>	40	1	39	40	This study
<i>HNF1B</i>	40	1	39	40	This study
<i>MT-TL1</i>	40	1	39	40	This study
<i>KCNJ11</i>	40	0	40	40	This study
<i>KLF11</i>	40	0	40	40	This study
<i>INS</i>	40	0	40	40	This study
Total:		34	34	68	

*One patient was excluded because presented antibodies against β -cell; #this study comprised three patients that were further excluded from the analysis.

Table 2. Variants identified in the Brazilian sample described by our group

Patient	Gene	GRCh38 location	Exon	RefSeq Gene position	Mutation cDNA level	Mutation protein level	Reference
P53	<i>GCK</i>	7:44153403	2	g.49768C>T	c.106C>T	p.(Arg36Trp)	(72)
P67	<i>GCK</i>	7:44153394	2	g.49777_49779del	c.115_117delAAG	p.(Lys39del)	(55)
P75	<i>GCK</i>	7:44153381	2	g.49790G>A	c.128G>A	p.(Arg43His)	(73)
P50	<i>GCK</i>	7:44153379	2	g.49792G>A	c.130G>A	p.(Gly44Ser)	(74)
P40	<i>GCK</i>	7:44153326	2	g.49843T>G	c.181T>G	p.(Tyr61Asp)	(10)
P46	<i>GCK</i>	7:44152291	3	g.50880A>G	c.343A>G	p.(Met115Val)	Novel
P1	<i>GCK</i>	7:44150990	4	g.52181_52183delTCT	c.449_451delTCT	p.(Phe150del)	(75)
P48	<i>GCK</i>	7:44149986	5	g.53185G>A	c.562G>A	p.(Ala188Thr)	(76)
P7	<i>GCK</i>	7:44149977	5	g.53194C>T	c.571C>T	p.(Arg191Trp)	(77)
P59	<i>GCK</i>	7:44149813	6	g.53358C>G	c.626C>G	p.(Thr209Arg)	(78)
P79	<i>GCK</i>	7:44149778	6	g.53393G>A	c.661G>A	p.(Glu221Lys)	(79)
P29	<i>GCK</i>	7:44147833	7	g.53412G>A	c.680G>A	p.(Gly227Asp)	(80)
P9	<i>GCK</i>	7:44147830	7	g.55341C>T	c.683C>T	p.(Thr228Met)	(81)
P68	<i>GCK</i>	7:44145674	9	g.57497C>T	c.1076C>T	p.(Pro359Leu)	(82)
P55	<i>GCK</i>	7:44145666	9	g.57515_57518C>TinsGCGA	c.1094_1095insGCGA	p.(Asp365GlufsTer95)	Novel
P32	<i>GCK</i>	7:44145599	9	g.57572C>T	c.1151C>T	p.(Ala384Val)	(83)
P45, P58, P63	<i>GCK</i>	7:44145266	10	g.57905T>A	c.1268T>A	p.(Phe423Tyr)	(84)
P4	<i>HNFI A</i>	12:120978860	1	g.5115G>A	c.92G>A	p.(Gly31Asp)	(62)
P28	<i>HNFI A</i>	12:120988904	2	g.15159G>A	c.398T>A	p.(Val133Glu)	(10)

P52	<i>HNFI1A</i>	12:120988993	2	g.15248T>C	c.489C>G	p.(Tyr163Ter)	Novel
P13	<i>HNFI1A</i>	12:120988999	2	g.15254G>A	c.493T>C	p.(Trp165Arg)	(85)
P37	<i>HNFI1A</i>	12:120989017	2	g.15272C>T	c.511C>T	p.(Arg171Ter)	(86)
P44, P70	<i>HNFI1A</i>	12:120994261	4	g.20516C>T	c.811C>T	p.(Arg271Trp)	(62)
P56	<i>HNFI1A</i>	12:120996571	6	g.22826_22827insC	c.1136_1137insC	p.(Val380CysfsTer39)	Novel
P5	<i>HNFI1A</i>	12:120996730	6	g.22985_22986insC	c.1296_1297insC	p.(Thr433HisfsTer116)	(10)
P23	<i>HNFI4A</i>	20:44413795	4	g.62995C>T	c.487C>T	p.(Arg163Ter)	(66)
P65	<i>HNFI1B</i>	17:37731814	4	g.18293C>T	c.826C>T	p.(Arg276Ter)	(69)
P24	<i>NEUROD1</i>	2:181678093	2	g.7570_7571delTT	c.766_767delTT	p.(Phe256LeufsTer2)	(12)
P35	<i>PAX4</i>	7:127613803	7	g.6924G>A	c.515G>A	p.(Arg172Gln)	(87)
P25	<i>PDX1</i>	13:27924381	2	g.9351G>A	c.532G>A	p.(Glu178Lys)	(88)
P26	<i>MT-TL1</i>	m.3243A>G	-	-	-	-	(89)

Ensembl HGVS: *GCK*: ENSG00000106633.17, ENST00000403799.8, NM_000162.5, NP_000153.1, NG_008847.2; *HNFI1A*: ENSG00000135100, ENST00000257555.11, NG_011731.2, NM_000545.8, NP_000536.5; *HNFI4A*: ENSG00000101076, ENST00000316099.9, NG_009818.1, NM_000457.5, NP_000448.3; *HNFI1B*: ENSG00000275410, ENST00000617811.5, NG_013019.2, NM_000458.4, NP_000449.1; *NEUROD1*: ENSG00000162992, ENST00000295108.4, NG_011820.2, NM_002500.5, NP_002491.3; *PAX4*: ENSG00000106331, ENST00000639438.3, NG_012848.1, NM_001366110.1, NP_001353039.1; *PDX1*: ENSG00000139515, ENST00000381033.5, NG_008183.1, NP_000200.1, NM_000209.4; *MT-TL1*: NC_012920, gi:251831106, AC_000021.2.

Table 3. Brazilian patient's clinical characteristics with mutations in genes associated to monogenic diabetes

Patient	Sex	At diagnose:		At entry in this study:						Gene with mutation	Segregation study?	Parental origin of the mutation
		Age (years)	BMI (kg/m ²)	Age (years)	BMI (kg/m ²)	FPG (mg/dl)	HbA1c %	Treatment	Clinical diagnostic			
1	F	11	n/i	31	22.9	n/i	6.1	OAD	MODY	<i>GCK</i>	No	-
4	F	13	< P90	23	24.2	118	8.6	OAD	MODY	<i>HNFI1A</i>	No	-
5	M	12	n/i	14	17.1	127	6.6	Diet	HNFI1A-MODY	<i>HNFI1A</i>	Yes	Mother
7	F	32	24.6	33	24.2	136	6.3	Diet	n/i	<i>GCK</i>	Yes	-
9	F	10	n/i	10	24	164	6	Diet	n/i	<i>GCK</i>	No	-
13	M	21	24	27	25.8	120	6.2	Ins	T1DM	<i>HNFI1A</i>	No	-
23	F	19	20	49	20.7	294	9.3	OAD	n/i	<i>HNFI4A</i>	Yes	-
24	M	25	28.9	30	27.8	137	7.5	OAD	MODY	<i>NEUROD1</i>	Yes	Mother
25	F	27	28.3	40	24	254	9.6	Ins	MODY	<i>PDX1</i>	Yes	-
26	M	28	25.9	30	20	116	5.6	OAD	T1DM	<i>MT-TL1</i>	No	-
28	F	22	19.9	36	18.8	91	5.9	OAD	n/i	<i>HNFI1A</i>	Yes	Mother
29	M	18	19.7	40	24.7	120	6.5	Diet	MODY	<i>GCK</i>	No	-
32	F	19	17.2	32	24.2	110	6.4	Diet	DMG	<i>GCK</i>	Yes	-
35	F	32	24.8	42	21.6	n/i	11	Ins	T2DM	<i>PAX4</i>	Yes	-
37	M	14	19.2	33	23.1	136	6.9	OAD	MODY	<i>HNFI1A</i>	No	-
40	M	12	n/i	21	24.6	n/i	6.3	Diet	n/i	<i>GCK</i>	Yes	Mother
44	M	21	23.8	34	n/i	n/i	7	Ins	n/i	<i>HNFI1A</i>	Yes	-
45	F	24	19.2	40	21.6	110	6.5	Diet	GCK-MODY	<i>GCK</i>	No	-
46	F	25	n/i	35	23	n/i	n/i	Diet	GCK-MODY	<i>GCK</i>	Yes	Father
48	M	3	< P95	10	n/i	120	6.8	Ins	T1DM	<i>GCK</i>	No	-
50	M	0.75	n/i	16	21	137	7	Ins	T1DM	<i>GCK</i>	Yes	Mother
52	F	15	n/i	49	25.8	n/i	8.3	OAD + Ins	T2DM	<i>HNFI1A</i>	Yes	-
53	F	15	n/i	31	19.2	112	6	Diet	MODY	<i>GCK</i>	Yes	Mother
55	M	26	22.3	32	26.1	109	6.1	Diet	n/i	<i>GCK</i>	Yes	Father
56	F	35	28.2	35	25.3	133	6.9	Ins	n/i	<i>HNFI1A</i>	No	-
58	M	8	< P85	13	16.4	122	n/i	Diet	T1DM	<i>GCK</i>	Yes	Mother
59	F	12	< P85	22	19.8	130	6.1	OAD	n/i	<i>GCK</i>	No	-
63	M	5	n/i	10	18.9	118	6.3	Ins	n/i	<i>GCK</i>	Yes	Mother
65	F	14	23.6	19	21.9	> 500	12.1	Ins	T1DM	<i>HNFI1B</i>	No	-
67	M	3	n/i	16	19.8	120	n/i	Diet	GCK-MODY	<i>GCK</i>	Yes	Mother
68	F	21	19.3	35	18.1	n/i	6.2	OAD	MODY	<i>GCK</i>	No	-
70	F	25	28.8	27	28	154	7	OAD	T2DM	<i>HNFI1A</i>	No	-
75	F	8	< P85	13	20.8	126	6.4	Diet	n/i	<i>GCK</i>	Yes	Father
79	M	5	< P85	17	19.6	139	7.2	OAD	T1DM	<i>GCK</i>	No	-

F: Female; M: Male; AAD: Age at diagnosis; P: Percentile; BMI: Body Mass Index; OAD: Oral antidiabetic agents; FPG: Fasting Plasma Glucose; HbA1c: Glycated hemoglobin; T1DM: Type 1 diabetes *mellitus*; T2DM:

Type 2 diabetes *mellitus*; n/i: Not informed.

Table 4. *In silico* algorithms prediction for the variants identified in the Brazilian patients described by our group

Gene	Mutations Mutation (protein level)	Prediction algorithms													
		Pathogenicity									Conservation				
		SIFT ^a	PROVEAN ^b	VEST ^c	Mutred ^d	FATHMM ^e	PolyPhen-2 (HumVar) ^f	Mutation Assessor ^g	Mutation Taster ^h	LRT ⁱ	GERP ⁺⁺ ^j	SiPhy ^k	phyloP_mammalian ^l	phast Cons ^m	Revel ⁿ
GCK	p.(Arg36Trp)	D	D	LP	P	D	PbD	M	DC	Dt	Nc	C	C	C	P
	p.(Arg43His)	D	D	LP	P	D	PbD	M	DC	Dt	C	C	C	C	P
	p.(Gly44Ser)	D	D	LP	P	D	PbD	H	DC	Dt	C	C	C	C	P
	p.(Tyr61Asp)	D	D	LP	P	D	PbD	H	DC	Dt	C	C	C	C	P
	p.(Met115Val)	D	N	LP	P	D	PbD	M	DC	Dt	C	C	C	C	P
	p.(Ala188Thr)	D	D	LP	P	D	PbD	M	DC	Dt	C	C	C	N	P
	p.(Arg191Trp)	D	D	LP	-	D	PbD	H	DC	Dt	Nc	C	C	C	P
	p.(Thr209Arg)	D	D	LP	P	D	PbD	H	DC	Dt	C	C	C	C	P
	p.(Glu221Lys)	T	D	LP	P	D	PbD	L	DC	Dt	C	C	C	C	P
	p.(Gly227Asp)	D	D	LP	P	D	PbD	M	DC	Dt	C	C	C	N	P
	p.(Thr228Met)	D	D	LP	P	D	PsD	H	DC	Dt	C	C	C	N	P
	p.(Pro359Leu)	T	N	LP	P	D	PsD	M	DC	Dt	C	C	C	C	P
	p.(Ala384Val)	D	D	LP	P	D	PsD	M	DC	Dt	C	C	C	N	P
	p.(Phe423Tyr)	D	N	LP	P	D	PbD		DC	Dt	C	C	C	C	P
	p.(Asp365GlufsTer95)	D	-	LP	-	-	-	-	-	-	-	-	-	-	-
	p.(Lys39del)	D	D	LP	-	-	-	-	-	-	-	-	-	-	-
	p.(Phe150del)	D	D	LP	-	-	-	-	-	-	-	-	-	-	-
HNF1A	p.(Gly31Asp)	T	N	LB	-	D	B	N	A	N	C	Nc	C	N	B
	p.(Val133Glu)	D	D	LP	P	D	PbD	M	DC	Dt	C	C	C	C	P
	p.(Trp165Arg)	D	D	LP	P	D	PbD	M	DC	Dt	C	C	C	C	P
	p.(Arg271Trp)	D	D	LP	P	D	PbD	M	DC	Dt	C	Nc	C	C	P
	p.(Tyr163Ter)	-	-	LP	-	-	-	-	A	Dt	C	Nc	C	C	-
	p.(Arg171Ter)	-	-	LP	-	-	-	-	A	Dt	C	C	C	C	-
	p.(Val380CysfsTer39)	D	-	LP	-	-	-	-	-	-	-	-	-	-	-
	p.(Thr433HisfsTer116)	D	-	LP	-	-	-	-	-	-	-	-	-	-	-
HNF4A	p.(Arg163Ter)	-	-	LP	-	-	-	-	A	N	C	C	C	C	-
HNF1B	p.(Arg276Ter)	-	-	LP	-	-	-	-	A	Dt	C	C	C	C	-
PAX4	p.Arg172Gln	D	D	LP	-	D	PbD	-	DC	Dt	C	C	C	C	P
PDX1	p.Glu178Lys	D	D	LP	P	D	PbD	M	A	Dt	C	C	C	C	P
NEUROD1	p.Phe256LeufsTer2	D	-	LP	-	-	-	-	-	-	-	-	-	-	-

D: Damaging; T: Tolerated; P: Pathogenic; Ds: Disease causing; A: Disease causing automatic; Dt: Deleterious;

N: Neutral; L: Low impact; M: Medium impact; H: High impact; PbD: Probably damaging; PsD: Possibly

damaging; B: Benign; LP: Likely pathogenic; LB: Likely benign; C: Conserved; Nc: Nonconserved; -: Not analyzed.

^a SIFT score < 0.05 is predicted as damaging.

^b PROVEAN score ≤ -2.5 is predicted as damaging and > -2.5 as neutral.

^c VEST score ranges from 0 to 1, the larger the score the more likely the mutation may cause functional change.

^d Mutation Assessor score ≤ 0.8 is predicted to have neutral impact, between > 0.8 and 1.9 low impact, between > 1.9 to ≤ 3.5 medium impact, and > 3.5 high impact.

^e MutPred score range from 0 to 1, the larger the score the more likely the damaging effect.

^f FATHMM score ≤ -1.5 is predicted as damaging and > -1.5 is predicted as tolerated.

^g Polyphen-2_HumVAR score between 0.909 and 1 is predicted as probably damaging, between 0.447 and 0.908 is predicted as possibly damaging, between 0 and 0.446 is predicted as benign.

^h MutationTaster prediction: A: disease causing automatic, D: disease causing, N: polymorphism or P: polymorphism automatic. The score cutoff between "D" and "N" is 0.5.

ⁱ LRT score ranges from 0 to 1 and which is not solely determined by the score. It is predicted as deleterious, neutral or unknown.

^j GERP++ scores range from -12.3 to 6.17 the larger the score, the more conserved the site. The score cutoff between nonconserved and conserved is ≥ 2.0 .

^k SiPhy score based on 29 mammals genomes. The larger the score, the more conserved the site. Scores range from 0 to 37.9718 in dbNSFP. The score cutoff between nonconserved and conserved is ≥ 12.17 (90).

^l PhyloP score based on 30 mammalian genomes (including human). The larger the score, the more conserved the site. Scores range from -20 to 1.312 in dbNSFP. The score cutoff between nonconserved and conserved is ≥ 0 .

^m PhastCons score based on the multiple alignments of 30 mammalian genomes (including human). The larger the score, the more conserved the site. The score cutoff between nonconserved and conserved is ≥ 0.5 .

ⁿ Revel score is based on 13 individual scores for predicting the pathogenicity of missense variants. Scores range from 0 to 1. The larger the score the more likely the SNP has damaging effect.

Table 5. Splice software predictions for *GCK* NM_000162.5: p.(Gly227Asp)

Splice-Site tools	Score	Consequence
ADA ^a	0.999687068188097	Alter the splicing of the gene
RF ^a	0.958	Alter the splicing of the gene
MaxEntScanDiff ^b	0.584	No splicing effect
Netgene2 ^c	0.85 (Ref: 0.85)	No splicing effect
NNSplice ^d	0.71 (Ref: 0.86)	No splicing effect
HMM-gene ^e	0.607 (Ref: 0.756)	No splicing effect
HSF	-	No splicing effect
FSPLICE ^f	8.28 (8.90)	No splicing effect

^a Adaptive Boosting algorithm (ADA) and Random Forest (RF) - Higher values indicate a greater probability that the variant will alter the splicing of the gene (threshold value: 0.60);

^b MaxEntScan - A positive score predicts a good splice site sequence context, whereas a negative score predicts a poor splice site sequence context; Ref: Reference; Mut: Mutated;

^c Netgene2 - Nearly all true acceptor sites: 20.0% (highly confident acceptor sites: 95.0%);

^d NNSplice - Higher score implies a higher probability/confidence of the sequence being a true splice site (threshold value: 0.40);

^e HMM-gene - A value close to one means that the program is fairly certain;

^f FSPLICE – Threshold value 4.175 (confidence: 90%).

ADA, RF, MaxEntScanDiff, Netgene2, NNSplice, HMM-gene, GenScan tools score ranges from 0 to 1

Table 6. Description of the variants identified in the Brazilian patients described by our group in public database

Variant	dbSNP	HGMD	gnomAD (allele frequency)	ClinVar	ACMG/AMP
<i>GCK</i> p.(Arg36Trp)	rs762263694	Yes	Yes (0.00001414)	P, LP	P
<i>GCK</i> p.(Lys39del)	-	-	-	US	LP
<i>GCK</i> p.(Arg43His)	rs764232985	Yes	Yes (0.0000039771)	LP	P
<i>GCK</i> p.(Gly44Ser)	rs267601516	Yes	-	P	P
<i>GCK</i> p.(Tyr61Asp)	-	-	-	-	LP
<i>GCK</i> p.(Met115Val)	rs771677681	-	Yes (0.00001193)	-	LP
<i>GCK</i> p.(Phe150del)	-	-	-	-	LP
<i>GCK</i> p.(Ala188Thr)	rs751279776	Yes	Yes (0.000003982)	P	LP
<i>GCK</i> p.(Arg191Trp)	rs1085307455	Yes	Yes (0.000007965)	P	P
<i>GCK</i> p.(Thr209Arg)	-	-	-	-	P
<i>GCK</i> p.(Glu221Lys)	rs193922317	Yes	-	P, LP	P
<i>GCK</i> p.(Gly227Asp)	-	-	-	-	P
<i>GCK</i> p.(Thr228Met)	rs80356655	Yes	Yes (0.000003999)	P	P
<i>GCK</i> p.(Pro359Leu)	-	Yes	-	-	LP
<i>GCK</i> p.(Asp365GlufsTer95)	-	-	-	-	P
<i>GCK</i> p.(Ala384Val)	rs1583591747	Yes	-	US	P
<i>GCK</i> p.(Phe423Tyr)	rs193922273	Yes	-	LP	LP
<i>HNF1A</i> p.(Gly31Asp)	rs137853247	Yes	Yes (0.0007500)	LB, US	B
<i>HNF1A</i> p.(Val133Glu)	-	-	-	-	US
<i>HNF1A</i> p.(Tyr163Ter)	-	-	-	-	P
<i>HNF1A</i> p.(Trp165Arg)	-	Yes	-	-	US
<i>HNF1A</i> p.(Arg171Ter)	rs1057520291	Yes	-	P	P
<i>HNF1A</i> p.(Arg271Trp)	rs886039386	Yes	-	P	LP
<i>HNF1A</i> p.(Val380CysfsTer39)	-	-	-	-	P
<i>HNF1A</i> p.(Thr433HisfsTer116)	-	-	-	-	P
<i>HNF4A</i> p.(Arg163Ter)	rs137853335	Yes	-	P	P
<i>HNF1B</i> p.(Arg276Ter)	rs121918672	Yes	-	P	P
<i>NEUROD1</i> p.(Phe256LeufsTer2)	rs1559135142	-	-	-	P
<i>PAX4</i> p.(Arg172Gln)	rs587780414	Yes	Yes (0.00004243)	US	LB
<i>PDX1</i> p.(Glu178Lys)	rs80356662	Yes	-	P	LP
<i>MT-TL1</i> m.3243A>G	rs199474657	-	-	P	US

P: Pathogenic; LP: Likely pathogenic; US: Uncertain significance; LB: Likely benign; B: Benign; -: Not available.

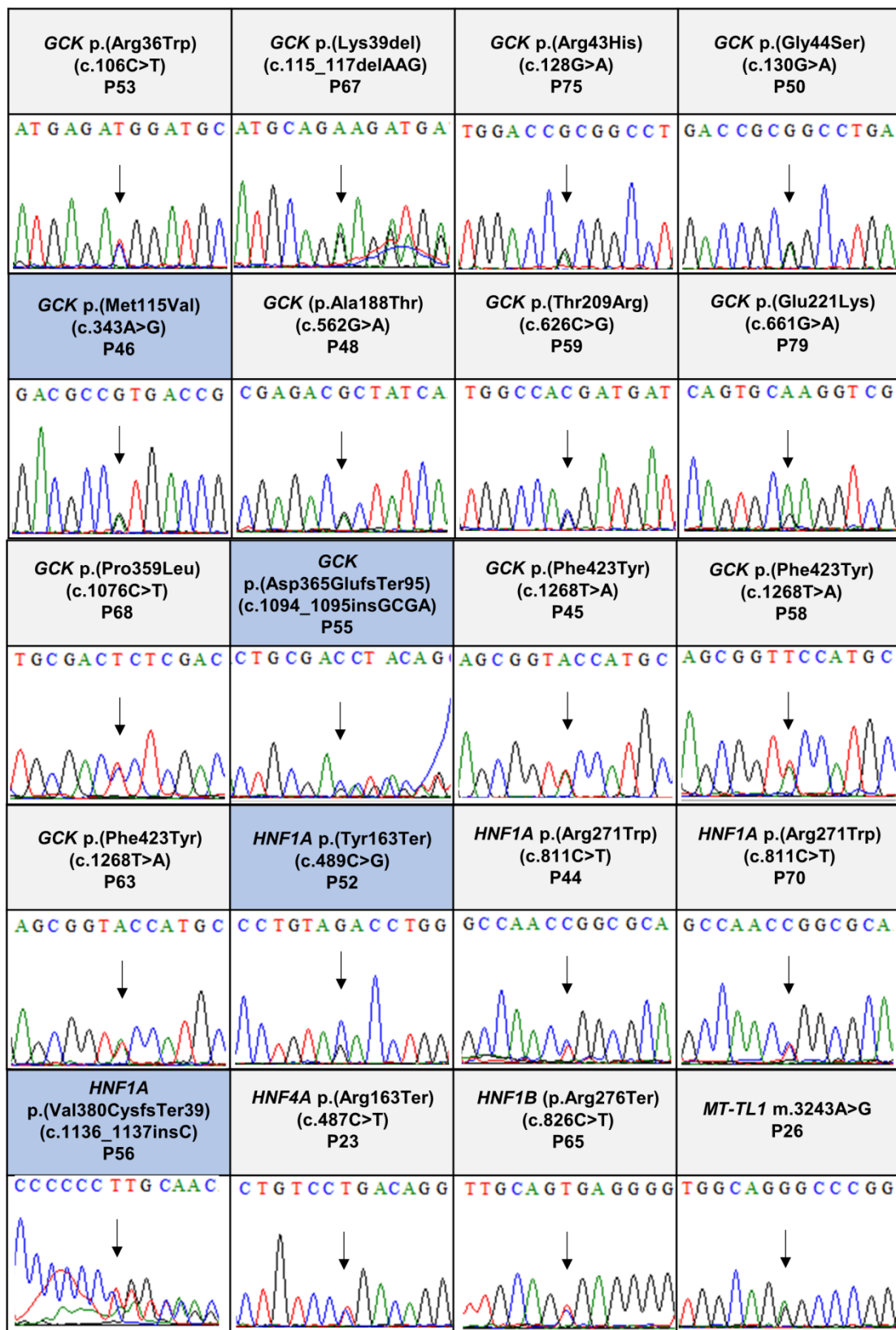
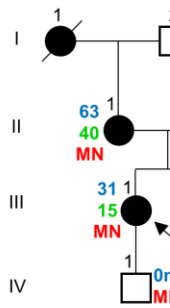
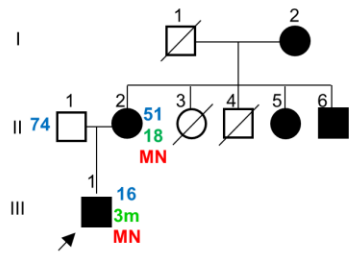

Figure 1. Electropherograms of mutations probably pathogenic found by Sanger sequencing among Brazilian patients with suspicious of monogenic diabetes. Novel mutations are showed in blue. An arrow indicates the position of the mutation in the electropherogram.

A GCK p.Arg36Trp
PEDIGREE 53



B GCK p.Lys39del
PEDIGREE 67



C GCK p.Arg43His
PEDIGREE 75

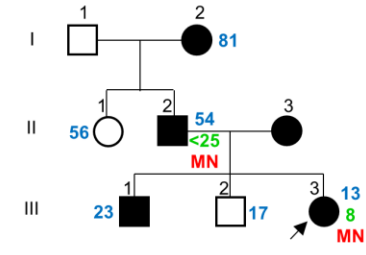

D GCK p.Gly44Ser
PEDIGREE 50

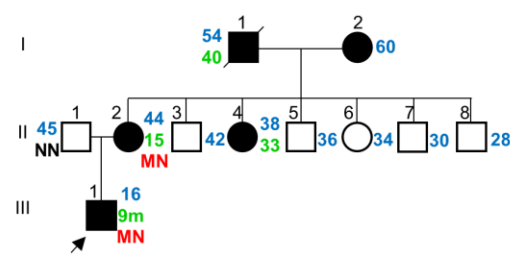

E GCK p.Met115Val
PEDIGREE 46

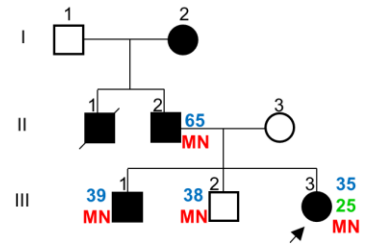

F GCK p.Arg191Trp
PEDIGREE 7

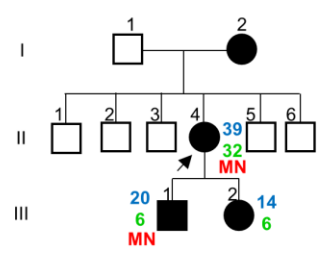

G GCK p.Asp365GlufsTer95
PEDIGREE 55

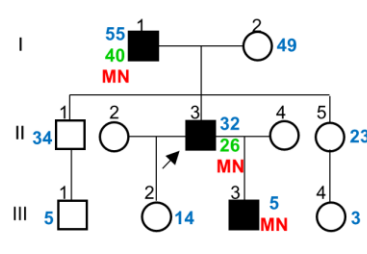

H GCK p.Ala384Val
PEDIGREE 32

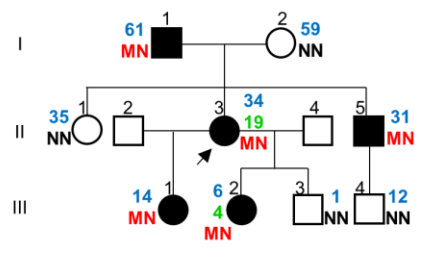

I GCK p.Phe423Tyr
PEDIGREE 58

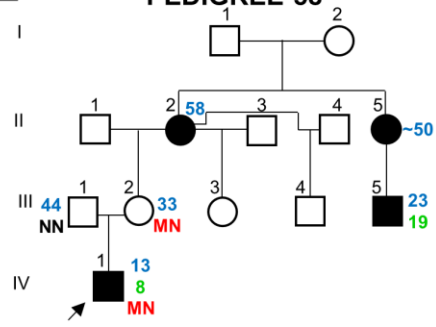

J GCK p.Phe423Tyr
PEDIGREE 63

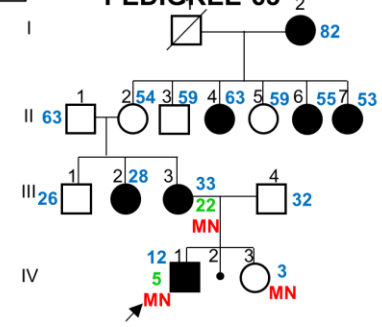

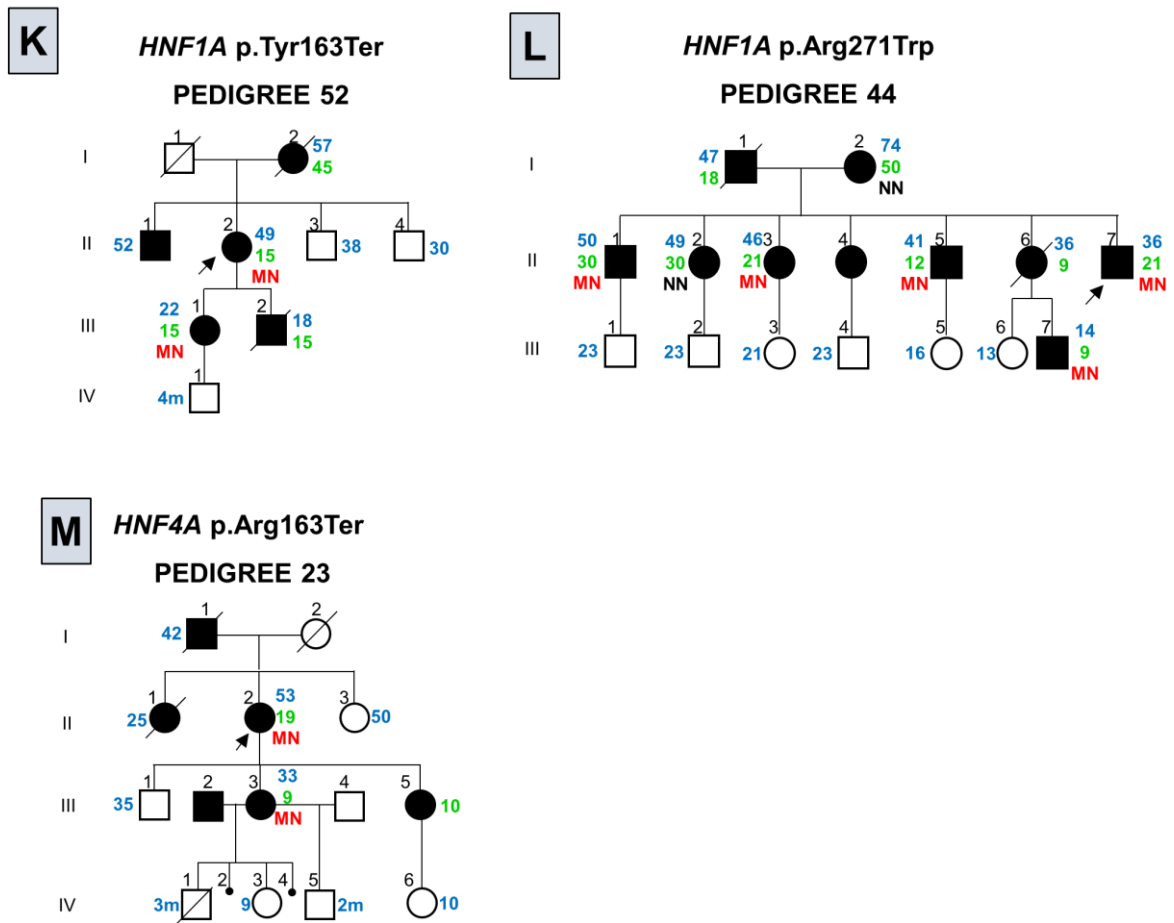

Figure 2. Pedigree of families with mutations in genes associated to monogenic diabetes. Filled black symbols, grey symbols and empty symbols represent diabetic patients, impaired tolerance glucose patients and healthy individuals, respectively. Small black circles represent miscarriage (letter J, individual IV-2; letter M, individuals IV-2 and IV-4). The present age of the individuals are show in blue and age at diagnosis in green, both are represent in years or months (m) when the age is followed by the letter M. Genotypes are expressed by homozygous normal allele (NN) and heterozygous mutated allele (MN) in red. Oblique lines through symbols represent deceased individuals. An arrow indicates the index case. In the pedigree 75 (letter C) < 25 indicates that the AAD was prior to the AAD usually observed for clinical criteria for MODY. In the pedigree 58 (letter I) the age of the individual II-5 was informed to be approximately (~) 50 years old. In the pedigree 23 (letter M) the family reported that the subject III-2 was diagnosed with MODY, although we are not able to confirm this information.

Supplementary Table S1. Sequence of primers and PCR conditions

Gene	Primers	Sequences 5' 3'	Ta °C	Amplicon bp	Protocol
<i>GCK</i>	E1F	GAAGGACACTAAGCCCCACAG	60	505	1
	E1R	GGCACCCCTGGCAAGACC			
	E2F	GGGTCAGAAGACAGAAGGAGGC	65	415	1
	E2R	CTGTCTCGGGCTGGCTGTG			
	E3F	CCTTAGTCCCTTGTGCCTTCC	65	388	1
	E3R	CCGCTCTCCCCACCCCTG			
	E4F	CAGCAGAGCATTTCAGCAGTATC	60	690	1
	E4R	GGGGCTACATTTGAAGGCAGAG			
	E5-6F	CTCCAGTATATGTTAGCAGC	60	504	1
	E5-6R	GATACCCCAAGACCACCCAGG			
	E7F	CACTGAAGCAACCCAGGTCT	60	596	1
	E7R	GATCACCTGTTCGGAAGGAAA			
	E8F	GAGGGAAAGACGTGAACCAG	62	438	1
	E8R	AGGCCCTAGTTTCCCATCC			
	E9-10F	CTGTCGGAGCGACACTCA	62	700	1
E9-10R	ATGGAGCCTGGGTGCTGT				
<i>HNF1A</i>	E1F	GTGGGTGCAAGGAGTTTGGT	60	490	1
	E1R	GGCCCTCTAGGCTCTCCT			
	E2F	GGGTTGACAAGGTTCCAGCA	60	431	1
	E2R	TGCAGGTTGAATCCCACTGAC			
	E3F	AGGTCAGGGGAATGGACG	60	353	1
	E3R	CTGGACAGCCTTTTACAGGACC			
	E4F	ACAGGGTTCCTCTGAGCCTG	60	370	1
	E4R	TGACTGCTGTCACTGGGACA			
	E5F	AAGTGCTGAGGGCTGTGGA	65	293	1
	E5R	CTGCTCCAGAATCTCCCTGC			
	E6F	AGGGAGATTCTGGAGCAGTCC	60	369	1
	E6R	TGAGTCCCAGTGGCTCTTCC			
	E7F	GCTGTTTCCTGACCACCCT	60	470	1
	E7R	CTGCAGACACCCTCAATCAC			
	E8-9F	CTGGGACTAGGGCTGTCAGG	60	454	1
	E8-9R	ACAGTAAGGGAGGGGGTGA			
	E10F	CTGCTGTGATCCAGGA	60	414	1
E10R	CCTCAGAGCCCTCCCTTTCT				
<i>HNF4A</i>	E1F	ATCTTCCCAGAGGACGGTTT	60	319	2
	E1R	CCAAAGATCTGCTCCTGGAC			
	E2F	AGGTGATGGAGTGGGAACAG	60	396	2
	E2R	TCTGGGACCTACCCACTCAG			
	E3F	CGGGATGAAGAGATGAGAGC	60	346	2
	E3R	TCTCAGCCATTAGCCAGTCA			
	E4F	GCTCCCACTCCTCATCAGTC	60	342	2
	E4R	TGTGAAACCGGACTCAGTGT			
	E5F	CTCCCTCCCTCCGTTTTTAC	60	406	2
	E5R	CCACGGCTATATCCCAGGT			
	E6F	TTCTTTCCCTTCCAGGTTT	60	418	2
	E6R	CTGGAGCCCTCTAATGCAAG			
	E7F	CCACAGGCACCAGCTATCTT	60	392	2

	E7R	AAATGAAAACGGCCTCTCCT			
	E8F	ACAAGTCAGGGGACATCTGG	60	391	2
	E8R	ACTGTGTGAGGCCTGTCTCC			
	E9F	TATTGGATGGGCTGGTTGAT	60	378	2
	E9R	ACCCTGGAACCCAGAAAACCT			
	E10F	AAAGGCTGGAATTTTGAGCA	60	324	2
	E10R	CCTTCATCCTTCCCATTCT			
<i>HNF1B</i>	E1F	TTCTGGATTTGGGGTTTGC	60	556	3
	E1R	GGGACTTCTCTGGTGGGAAA			
	E2F	GCAGTCACCTTCTCCTCTGT	60	417	3
	E2R	ACTTCAGGTTGAGGCAGAGG			
	E3F	TCCGTTGTCTGTCTGTCTGT	56	498	2
	E3R	TTGATATTGGGGTTCTGTGGAA			
	E4F	CCCCTTCATACTCCCAACCA	56	481	2
	E4R	ATTCTGGCAATGAGAGAGCG			
	E5F	TGGACAGGGGAGGAGAAAG	56	398	2
	E5R	CCTATGGGGCTACAATGGTTC			
	E6F	CACCATGCCAGCCAATAAT	56	392	2
	E6R	TCGTGGGTGAGTTTGAAGGA			
	E7F	TAATGCCCATCTCCAACCCA	60	479	3
	E7R	AGAGAGGGAAAGTGGTTGGC			
	E8F	AGATGGGAGCTATGGTGTGG	59	334	2
	E8R	AACAACAGGGAGCCTCAGAA			
	E9F	AGAACTGAGCAGACACGAGG	59	332	2
E9R	AGTGGATTGTCTGAGGTGCC				
<i>INS</i>	E1F	CCTTCAGCCTGCCTCAGC	60	398	4
	E1R	CACTTTTAGGACGTGACCAAGA			
	E2F	TGGAGATGGGTGGGAGTG	60	372	3
	E2R	AAGACACACAGACGGCACAG			
<i>NEUROD1</i>	E1aF	GGTTTAGGGAGTGAAGCTGA	60	650	5
	E1aR	GTTGGTGGTGGGTTGGGATA			
	E1bF	TACATCTGGGCTCTGTCGGA	60	676	3
	E1bR	TGTAAGCACAGTGGGTTTCGT			
<i>KLF11</i>	E1F	AGGGGCGCGGTGTATTTTG	60	389	2
	E1R	CCCACCTCCCGCATTAC			
	E2F	TCGGTGTGTTGCTATAGACT	60	500	2
	E2R	CCAGGGAATCTTCTCACAAGT			
	E3aF	AAGGTATTGGGAGCATTGTGA	67	650	1
	E3aR	TCCAGTCACAGGGATCATCT			
	E3bF	GGTGTCTGTGTCAGCCCTG	68	648	1
	E3bR	AAAGGCGGCTCAAGGTGTG			
	E4F	AGTGTGGGAGGAATAAATGCC	67	495	1
E4R	AAAATCCCATGAGTGATGTCCT				
<i>KCNJ11</i>	E1aF	AGAGTCTGGTGGGGAGTTATCT	60	589	2
	E1aR	GGGCACTCCTCAGTCACC			
	E1bF	TCTTCACCATGTCCTTCCTGTG	60	586	5
	E1bR	TCGTAGAGTGGGCTGTTGG			
	E1cF	TGGCCCCGCTGATCATCTA	60	483	2
	E1cR	GCCGGGCTACATAACCAT			
<i>PAX4</i>	E1F	GGGTATGGGCAAGGAACAAA	60	493	2

	E1R	CCCCTTTTCAACCTCCGAGA			
	E2F	TGGCCTGGTCCAGTAAGTCT	60	509	2
	E2R	GCTTTCTCCTTCCCAATCCT			
	E3F	AGGATTGGGAAGGAGAAAGCA	63	473	2
	E3R	GGGACCTGTGTTCTGTTCCA			
	E4F	GGTATTGAGCACCTTTCCA	60	415	2
	E4R	CACTCACACCTGCACCTCTC			
	E5F	GTTTGGGGTTGTAGCAGGTG	60	418	2
	E5R	CCCTCCCTGCTCTAGCTTTT			
	E6F	TCTTCCCAACCCAAACCTT	60	301	3
	E6R	GATAGATGACTGAGCGGGCA			
	E7F	AAGGACCTGTCTTGGGGAAG	60	312	2
	E7R	GCTCAGGCCAGAAATGGAAG			
	E8F	ATACTACTTGGGTGGCAGGC	60	502	3
	E8R	GGGAGAGAGGCTGAGACATC			
	E9F	CAGGGTGGGAAACTGATGTC	60	447	3
	E9R	GTGAGAAGTGGGTGGGTGTT			
<i>MT-TLI</i>	F	CCTCCCTGTACGAAAGGACA	60	412	2
	R	GCGGTGATGTAGAGGGTGAT			

Ta: annealing temperature; bp: base pairs; F: Forward; R: Reverse; Protocol used for each reaction described above;

PCR conditions:

- **Protocol 1** - 50 ng of Genomic DNA, 1 unit of AmpliTaq DNA Polymerase (Applied Biosystems, Foster City, CA, USA), 1X PCR Buffer I (contains 15 mM MgCl₂) (Applied Biosystems, Foster City, CA, USA), 0.2 mM of each dNTP and 0.4 μM of each primer.
- **Protocol 2** - 50 ng of Genomic DNA, 1.5 unit of Taq DNA Polymerase Brasil (Invitrogen, CA, USA), 1X PCR Buffer (Invitrogen, CA, USA), 0.2 mM of each dNTP, 2 mM of MgCl₂ and 0.4 μM of each primer.
- **Protocol 3** – 50 ng of Genomic DNA, 2 unit of FastStart Taq DNA Polymerase (Roche Diagnostics, Mannheim, Germany), 1X PCR Reaction Buffer (Roche Diagnostics, Mannheim, Germany), 2 mM of MgCl₂, 1X GC-RICH Solution (Roche Diagnostics, Mannheim, Germany), 0.2 mM of each dNTP, 2 mM of MgCl₂ and 0.4 μM of each primer.
- **Protocol 4** - 50 ng of Genomic DNA, 1 unit of Platinum Taq DNA Polymerase High Fidelity (Invitrogen, CA, USA), 1X High fidelity PCR Buffer (Invitrogen, CA, USA), 0.2 mM of each dNTP, 2 mM of MgSO₄ and 0.4 μM of each primer.
- **Protocol 5** – 50 ng of Genomic DNA, 1.25 unit of AmpliTaq Gold™ DNA Polymerase (Applied Biosystems, CA, USA), 1X PCR Gold Buffer (Applied Biosystems, CA, USA), 0.2 mM of each dNTP, 2 mM of MgCl₂ (Applied Biosystems, CA, USA), and 0.4 μM of each primer.

Cycling conditions:

- **Protocol 1** - 95 °C for 10 min, followed by 40 cycles of 94 °C for 1 min, gene-specific annealing temperature (°C) for 1 min and 72 °C for 1 min; and a final extension of 72 °C for 10 min.

- **Protocol 2** - 95 °C for 10 min, followed by 40 cycles of 95 °C for 1 min, gene-specific annealing temperature (°C) for 1 min and 72 °C for 1 min; and a final extension of 72 °C for 10 min.
- **Protocol 3** - 95 °C for 4 min, followed by 40 cycles of 95 °C for 30 s, gene-specific annealing temperature (°C) for 30 s and 72 °C for 1 min; and a final extension of 72 °C for 10 min.
- **Protocol 4** - 96 °C for 9 min, followed by 40 cycles of 96 °C for 1min, gene-specific annealing temperature (°C) for 1 min and 30 s and 72 °C for 1 min; and a final extension of 72 °C for 10 min.
- **Protocol 5** - 95 °C for 10 min, followed by 40 cycles of 94 °C for 1min, gene-specific annealing temperature (°C) for 1 min and 72 °C for 1 min; and a final extension of 72 °C for 10 min.

4. Discussão

O Brasil figura em quinto lugar entre os países com maior número de casos de diabetes *mellitus* no mundo, sendo o terceiro país com mais gastos com tratamento de DM e suas complicações (1). Apesar da importante implicação clínica da investigação das formas monogênicas do diabetes, estudos objetivando essas formas ainda são escassos, principalmente em populações em desenvolvimento e subdesenvolvimento, tendo implicações negativas diretas no manejo do paciente e no custo-benefício. No Brasil, ainda há poucos relatos de pacientes com diabetes monogênico, e o papel destas formas raras em nossa população não é totalmente conhecido. Além disso, a maioria dos trabalhos na população brasileira se limita ao estudo dos genes mais frequentes (*GCK*, *HNF1A*, *HNF4A* e *HNF1B*). O rastreamento apenas das formas mais comuns resulta em uma grande parcela de pacientes subdiagnosticados, subestimando o possível papel dos demais genes como causa de diabetes monogênico na nossa população. Desta forma, com o intuito de aumentar o conhecimento do perfil genético das formas monogênicas de diabetes na nossa população, onze genes foram investigados (*HNF4A*, *GCK*, *HNF1A*, *HNF1B*, *PDX1*, *NEUROD1*, *KLF11*, *PAX4*, *INS*, *KCNJ11* e *MT-TL1*) nesse estudo, em uma amostra da população brasileira.

Neste estudo foram identificadas modificações em 50% do total da amostras analisada (34/68 pacientes), sendo a maior frequência de modificações encontrada entre os genes mais comuns, *GCK* e *HNF1A*. Dentre os 26 pacientes que tinham perfil clínico para GCK-MODY, 19 (73%) apresentaram modificações no gene *GCK*. O grupo composto por 42 pacientes que foram analisados para o gene *HNF1A* apresentou 9 (21,42%) pacientes com modificações nesse gene. Os genes *HNF4A* e *HNF1B*, apresentaram uma frequência de 2,5% (1/40) cada. A análise dos genes raros revelou uma frequência de 7,5% (3/40) (*NEUROD1*, *PAX4* e *PDX1*). Além disso, identificamos um paciente com a mutação m.3243A>G no gene mitocondrial *MT-TL1* (2,5%; 1/40). Em nosso estudo não observamos modificações nos genes *KCNJ11*, *INS* e *KLF11* (**Gráfico 1**).



Gráfico 1. Modificações identificadas neste estudo, distribuídas por gene.

Mutações nos genes *GCK* e *HNF1A* são descritas como as causas mais frequentes de MODY no mundo (45). Apesar da frequência encontrada no gene *GCK* em nosso estudo ter sido 4 vezes superior a encontrada para o gene *HNF1A*, ao observar esses dados, deve-se levar em consideração que nesse estudo os nossos critérios para seleção dos pacientes foram diferenciados, e que pacientes com *GCK*-MODY possuem um fenótipo clínico distinto das demais formas, sendo seu diagnóstico clínico mais assertivo.

Juntamente com as mutações nos genes *GCK* e *HNF1A*, mutações nos genes *HNF4A* e *HNF1B* figuram entre as causas mais frequentes de diabetes do tipo MODY. Estudos em populações Caucásicas apontam mutações nestes genes como causa de 95% dos casos de MODY (45,256), sendo a frequência do *HNF4A* e *HNF1B* de 20% e 5%, respectivamente e dos genes raros variando de 0 a < 1% (256). Entretanto, em nosso estudo a frequência de modificações nos genes *HNF4A* e *HNF1B* foi a mesma das frequências encontradas nos genes reportados como raros, *NEUROD1*, *PAX4* e *PDX1* (2,5% cada). Este resultado ressalta a importância do rastreamento de outros genes associados ao diabetes, principalmente em populações miscigenadas, demonstrando que as frequências encontradas na população brasileira pode ser diferente das já descritas.

Em relação ao gene *PDX1*, além do nosso relato de caso (257), um outro paciente brasileiro já havia sido reportado com *PDX1*-MODY (245), reforçando que as frequências em nossa população podem ser diferentes das demais, principalmente das populações europeias, que já possuem frequências bem definidas na literatura (131–133). A ausência de

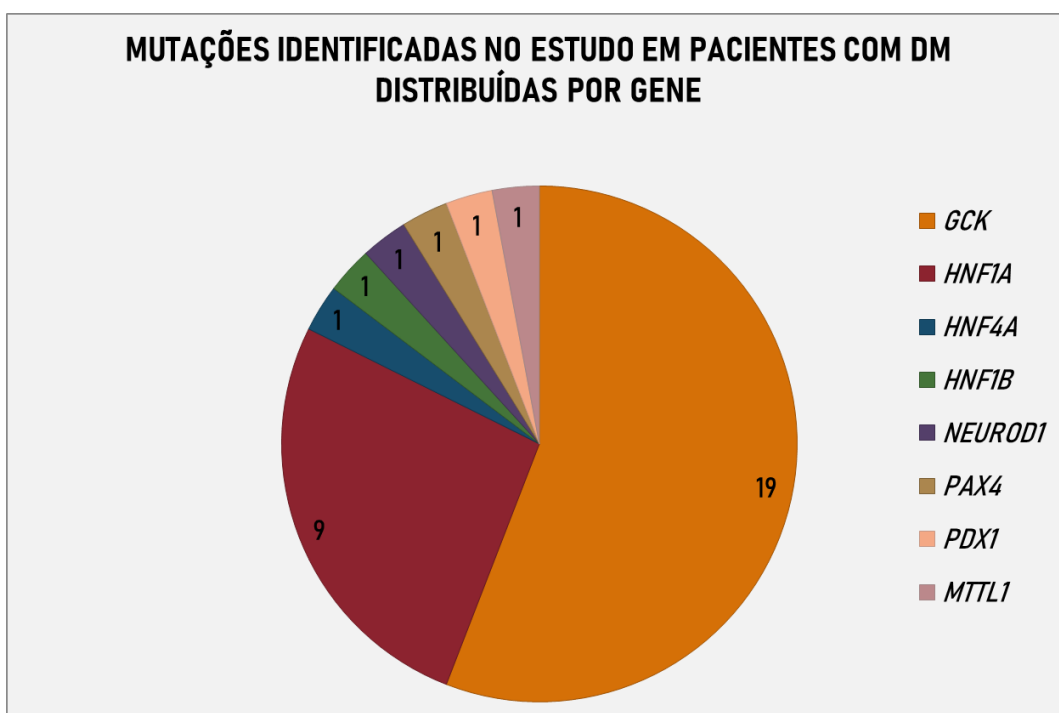
modificações nos genes *KCNJ11*, *INS* e *KLF11* em nossa amostra sugere que alterações nesses genes como causa de MODY são raras, além disso, esse resultado era esperado visto que dados da literatura apontam mutações nos genes *KCNJ11* e *INS* mais associadas como causa de diabetes neonatal (48,52,219,221).

A identificação de mutações no diagnóstico molecular como ferramenta complementar para o correto diagnóstico clínico tem grande implicação no prognóstico da doença, bem como na escolha da melhor estratégia de tratamento e no aconselhamento genético familiar. Ao entrar no nosso estudo, sete pacientes haviam sido diagnosticados com DM do tipo 1. Entre esses pacientes, quatro pacientes tiveram o diagnóstico molecular de GCK-MODY e um de HNF1A-MODY. Três pacientes haviam sido diagnosticados com DM do tipo 2, e identificamos modificações no gene *HNF1A* em dois destes indivíduos. Além disso, uma paciente havia recebido o diagnóstico de DM gestacional, sendo diagnosticada como GCK-MODY após este estudo, e 11 pacientes estavam sem nenhum diagnóstico (**Gráfico 2 e 3**).



Gráfico 2. Suspeita de diagnóstico clínico *versus* diagnóstico molecular pacientes do grupo GCK-MODY.



Gráfico 3. Suspeita de diagnóstico clínico *versus* diagnóstico molecular pacientes do grupo não GCK-MODY.

O diagnóstico clínico das formas monogênicas tem aplicação direta no tratamento e prognóstico dos pacientes. Atualmente, um dos grandes exemplos da aplicação do diagnóstico molecular na prática clínica são os casos de pacientes com mutações inativadoras em heterozigose no gene (*GCK*) da glicoquinase que apresentam hiperglicemia leve desde o nascimento e são assintomáticos. Quando se confirma o diagnóstico molecular destes pacientes, aqueles que faziam uso de medicamentos orais, ou mesmo uso de insulina, podem fazer a troca para dieta e exercícios físicos, como foi o caso de seis pacientes diagnosticados com GCK-MODY do nosso estudo, três estavam utilizando insulina e três estavam com medicamentos orais. Após o diagnóstico molecular esses pacientes puderam controlar a glicemia apenas através de dieta e exercícios físicos (**Gráfico 4**). Outro benefício do diagnóstico molecular, é através do monitoramento de mulheres grávidas com GCK-MODY que podem gerar bebês macrossômicos (131,132). Como foi o caso da paciente P53, que recebeu o diagnóstico de GCK-MODY antes de sua primeira gestação e fez uso de insulina durante esse período. Além disso, durante o parto, o sangue do cordão umbilical do bebê desta paciente foi coletado de modo a rastrear o DNA do recém-nascido para modificação da mãe. O teste genético revelou que o bebê havia herdado a modificação presente na mãe. Desta forma, não era necessário o uso de insulina durante essa gravidez, visto que mãe e filho

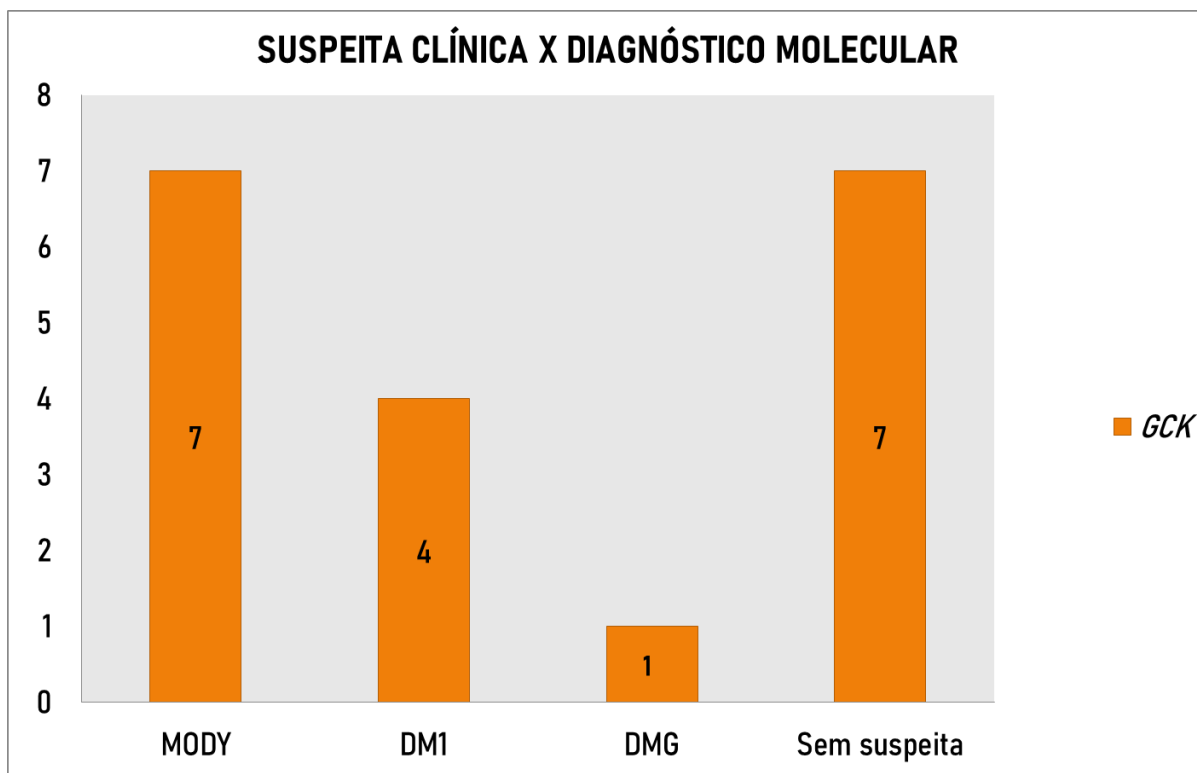
respondem igualmente ao incremento de glicose. Por isso faz-se necessário a utilização de novas técnicas não invasivas, como o “droplet digital PCR”, para o diagnóstico molecular fetal no início da gravidez (139).

Outra aplicação clínica do diagnóstico molecular é quando se identificam modificações patogênicas causadoras de HNF1A-MODY em pacientes tratados com insulina. Nestes casos, dependendo da evolução clínica do paciente e a duração da doença, pode ser realizada a substituição da injeção de insulina por medicamentos orais, melhorando a qualidade de vida do paciente e seu prognóstico (258), visto que estes pacientes possuem boas respostas a baixas doses de sulfonilureias durante anos (165). No nosso estudo, o tratamento dos pacientes P44 e P56 puderam ser modificados de insulina para medicamentos orais, obtendo boa resposta nas taxas glicêmicas.

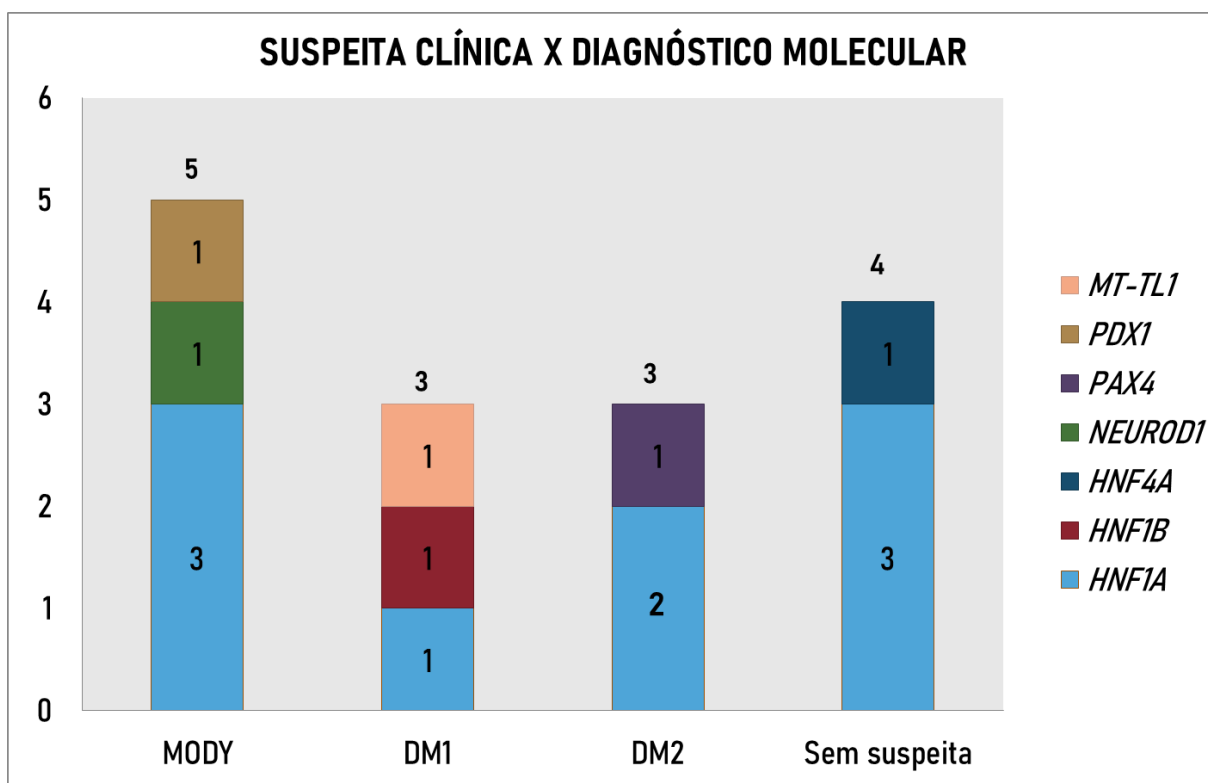

Gráfico 4. Tratamento dos pacientes identificados com DM monogênico antes do diagnóstico molecular.

Além dos probandos, os familiares afetados desses indivíduos são beneficiados pelo teste genético, podendo ter uma melhora em seu tratamento, prognóstico e qualidade de vida. Em nosso estudo 19 famílias (62 familiares) foram estudadas para as modificações identificadas no caso-índice. Dos 62 indivíduos, 41 apresentaram a modificação estudada e destes, 34 reportaram ter diabetes. Entretanto, curiosamente sete indivíduos com as modificações estudadas não reportaram hiperglicemia. Dentre esses sete indivíduos, nós não tivemos acesso aos exames bioquímicos de três deles; incluindo o filho recém-nascido da probanda P53 (GCK-MODY), o irmão da paciente P46 (GCK-MODY) e a mãe da paciente

P28 (HNF1A-MODY). Os quatro carreadores não diabéticos restantes foram observados na família P35, com modificação no gene *PAX4*. Acreditamos que essa modificação possa ser responsável por uma manifestação mais tardia da doença (259).

Com relação aos cinco pacientes com diabetes e que apresentaram alelos normais para a modificação identificada no probando, dois pacientes eram pais dos probandos com GCK-MODY P40 e P53 e, e tiveram o diagnóstico tardio com 48 e 64 anos, respectivamente, idade de diagnóstico compatível com diabetes do tipo 2. Nos dois casos as modificações foram confirmadas segregarem através das mães dos probandos. Além disso, não observamos a modificação no gene *HNF1A* na mãe e irmã do probando P44. Ambas tiveram o diagnóstico mais tardiamente do que dos outros familiares, 50 e 30 anos respectivamente, e possuíam sobrepeso. Acreditamos que esses dois casos sejam fenocópias da doença. O pai do probando P44 é falecido e não pode ter seu material genético testado, entretanto a família relatou que ele teve o diagnóstico aos 18 anos, era magro e tinha irmãos com DM. Dessa forma, acreditamos que essa modificação tenha sido transmitida pelo pai do probando. O último caso, é a irmã da paciente P35 com *PAX4*-MODY, diagnosticada aos 25 anos com DM gestacional. Assim como no caso da família P44, acreditamos se tratar de uma fenocópia, visto que ela reportou ter DM gestacional (**Gráfico 5**).

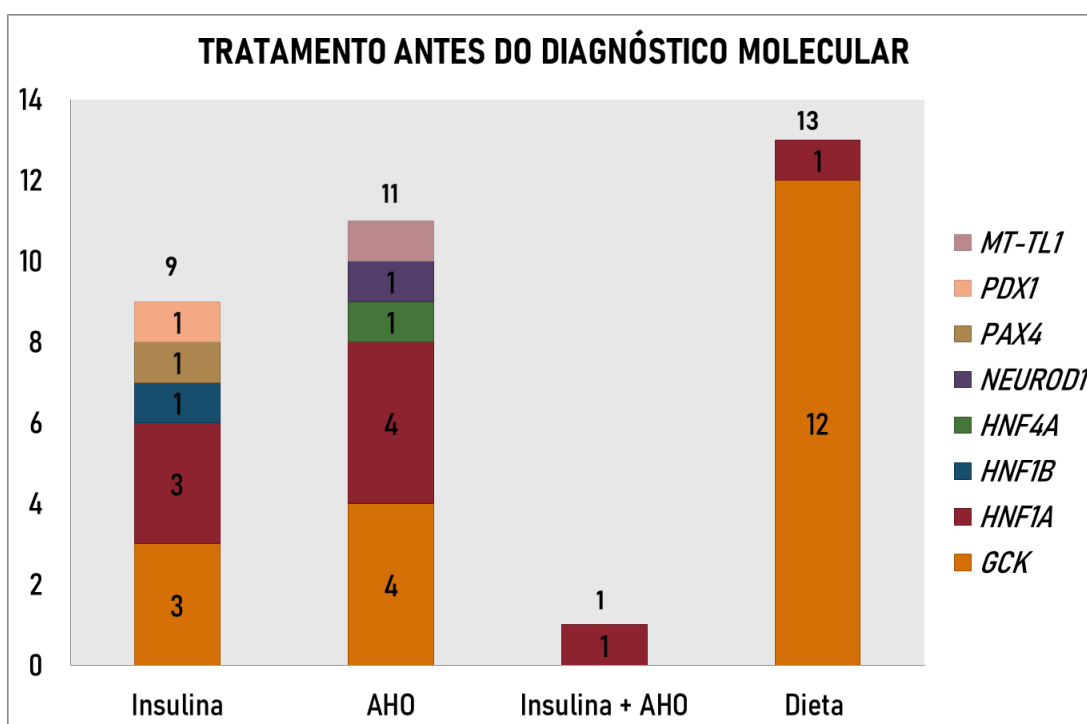

Gráfico 5. Distribuição de familiares com diabetes ou não *versus* a presença e ausência da modificação.

O rastreamento molecular através da técnica de sequenciamento de Sanger permite a identificação de diferentes tipos de modificações. Neste estudo observamos modificações de sentido trocado, sem sentido, com mudança no quadro de leitura e deleção de um único códon. A modificação do tipo sentido trocado foi a mais predominante, representando 64,5% do total (**Gráfico 6**).

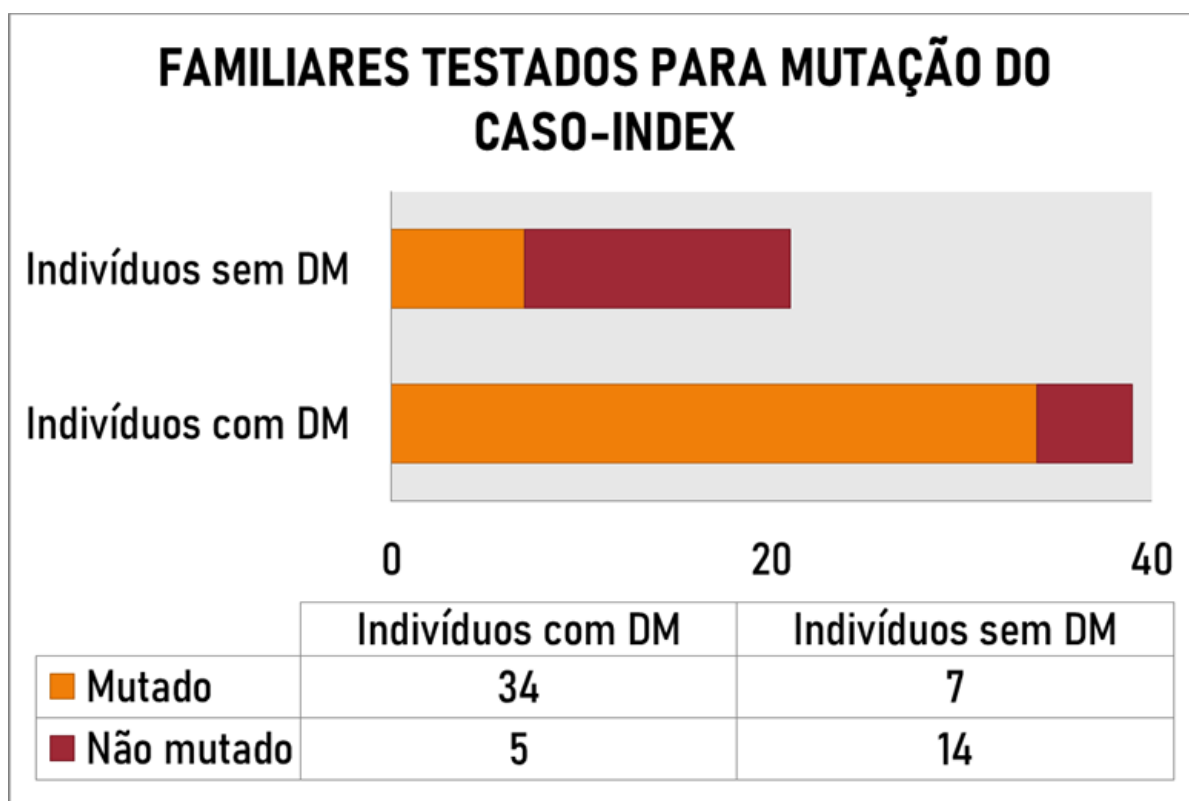

Gráfico 6. Tipos de modificações identificadas nesse estudo por gene.

Dentre as 31 diferentes modificações identificadas, oito foram novas, sendo três no gene *GCK* ((p.(Tir61Asp), p.(Met115Val) e p.(Asp365GlufsTer95)), quatro no gene *HNF1A* (p.(Val133Glu), p.(Tir163Ter), p.(Val380CisfsTer39) e p.(Tre433HisfsTer116)), e uma modificação no gene *NEUROD1* (p.(Fen256LeufsTer2)). Com relação às análises *in silico*, todas as modificações novas foram preditas como provavelmente patogênicas pela maioria dos programas. Com relação à patogenicidade utilizando a classificação do ACMG, apenas as variantes *GCK* p.(Met115Val) e *HNF1A* p.(Val133Glu) foram descritas com significância incerta; as demais foram classificadas como patogênicas ou provavelmente patogênicas. Dentre as oito novas variantes, foi possível observar a segregação da modificação com a doença em seis famílias; não foi possível o contato com a família da Paciente P56 no momento do estudo e a modificação p.(Val133Glu) identificada na probanda P28, apesar de ser observada em duas irmãs diabéticas, a mãe, com 70 anos, não apresentou hiperglicemia.

Estudos futuros são necessários para analisar a patogenicidade e a penetrância da variante p.(Val133Glu) no gene *HNF1A*.

No gene *GCK*, 14 modificações de sentido trocado foram observadas, seguidas por duas deleções de um único códon e uma modificação com mudança no quadro de leitura. Mutações no gene *GCK* são descritas ao longo de todos os 10 éxons do gene. Em nossa amostra, dos 17 tipos diferentes de modificações identificadas, cinco (11,8%) foram identificadas no éxon 2, fora da região do subdomínio maior. Contudo, apesar de mutações neste éxon parecerem mais frequentes, o rastreamento de toda região codificadora deste gene é crucial, visto que, além de modificações no éxon 2, nós identificamos variantes em quase todos os éxons, com exceção dos éxons 1 e 8 (**Figura 22**).

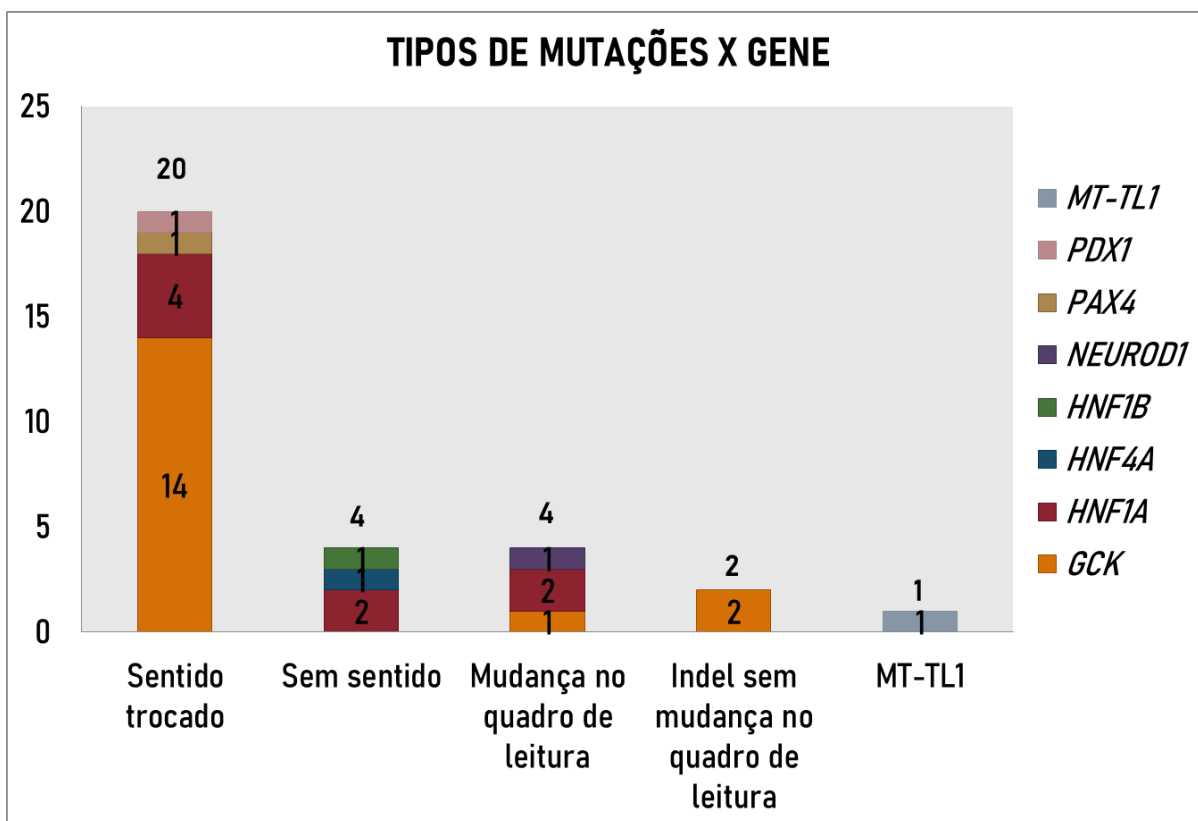
Gene *GCK*



Figura 22. Distribuição das modificações identificadas neste estudo ao longo dos éxons do gene *GCK*. Em vermelho estão destacadas as modificações novas. **Fonte:** O autor.

As modificações identificadas no gene *HNF1A* tiveram maior ocorrência no domínio de ligação ao DNA, sendo três do tipo sentido trocado e duas sem sentido. As duas modificações que mudam o quadro de leitura, foram identificadas no éxon 6, correspondente ao domínio de transativação. É possível que essas modificações façam com que a proteína *HNF1A* seja produzida de forma truncada, sem a função de ativação ou mesmo não seja produzida. A única modificação identificada fora dos domínios na proteína *HNF1A* foi a variante p.(Gli31Asp), identificada no éxon 1, além disso, ela foi a única variante predita como benigna pela maioria dos algoritmos *in silico* utilizados (**Figura 23**).

Gene *HNF1A*

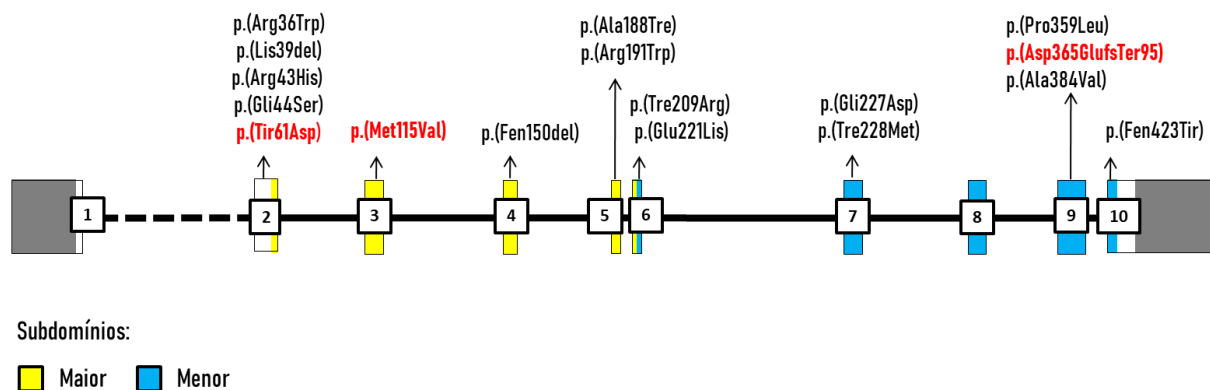

Figura 23. Distribuição das modificações identificadas neste estudo ao longo dos éxons do gene *HNF1A*. Em vermelho estão destacadas as modificações novas. **Fonte:** O autor.

A *HNF1A* p.(Gli31Asp) é uma variante amplamente descrita na literatura associada à MODY, sendo encontrada nas populações francesa (260), espanhola (261) e mesmo em pacientes brasileiros (262). Apesar de ter vários relatos dessa variante associados à DM do tipo MODY, a sua patogenicidade ainda não é clara. Essa variante foi identificada em 82 alelos do ExAC (Frequência do alelo A: 0,0007), não segregou com a doença em estudos prévios (263), e foi predita como benigna pelas nossas análises *in silico* e foi a única variante identificada em nosso estudo fora dos domínios da proteína HNF1A, levantando dúvidas do real papel da variante p.(Gli31Asp) como causa de diabetes monogênico. A análise da segregação na família da paciente P4 do nosso estudo poderá contribuir para seu maior entendimento. Estudos futuros são necessários para avaliarmos o seu papel.

Após as análises dos genes mais frequentes associados ao diabetes do tipo MODY, decidimos realizar o estudo do gene mitocondrial *MT-TL1*, apesar dos nossos pacientes não apresentarem fenótipos clínicos indicativos de MIDD ou MELAS. Como resultado, identificamos um paciente com a mutação m.3243A>G em heteroplasmia nos linfócitos das células sanguíneas periféricas. O paciente foi diagnosticado aos 28 anos de idade com DM do tipo 1. Ele relatou ter vários familiares afetados por DM (mãe, pai e todos os oito irmãos). Entretanto o estudo de segregação não foi possível. Apesar da variante m.3243A>G ser associada a várias síndromes (264,265), pode levar ao aparecimento apenas de alguns sintomas, sendo os pacientes denominados como oligossintomáticos (266), ou até mesmo estar presente em portadores assintomáticos (266). O fenótipo clínico vai depender, portanto, do grau de heteroplasmia da mutação (267,268). O paciente P28 parece se enquadrar entre os pacientes oligossintomáticos, pois não reportou qualquer alteração adicional além do diabetes. Estudos de segregação, bem como análises do grau de heteroplasmia de outros tecidos, tais como saliva, são de grande importância para o esclarecimento deste tipo de caso clínico.

Até recentemente, no Brasil, o diagnóstico molecular era baseado no rastreamento das regiões codificadoras dos genes *GCK* e *HNF1A* através de sequenciamento automático de Sanger (104,269). Neste estudo, abordamos o rastreamento de outros genes associados a esta condição e demonstramos a sua importância na resposta aos casos negativos para o rastreamento dos genes mais frequentes. Apesar da alta taxa de positividade (50%), utilizando o sequenciamento de Sanger, essa tecnologia tem suas limitações principalmente porque ela não analisa grandes deleções e inserções no genoma e também não analisa outros genes raros, conhecidos ou não, que podem estar relacionados com a doença. Diversos estudos já demonstraram a vantagem da aplicação do sequenciamento massivo paralelo (*Next-Generation Sequencing-NGS*) em pacientes com fenótipo clínico de diabetes monogênico, visto que o NGS fornece resultados mais rápidos, aumenta a acurácia do diagnóstico e é mais econômico comparado ao sequenciamento automático de Sanger (270). Além disso, o diagnóstico de múltiplos genes aumenta a identificação de pacientes com formas monogênicas (271). Desta forma, acreditamos que a expansão do rastreamento para outros genes em pacientes sem mutações identificadas nos genes estudados e a aplicação da análise do exoma completo naqueles pacientes com fenótipo clínico característico e forte história familiar, aumentará a eficiência dos métodos de diagnóstico molecular e a identificação de novos genes associados a esta doença.

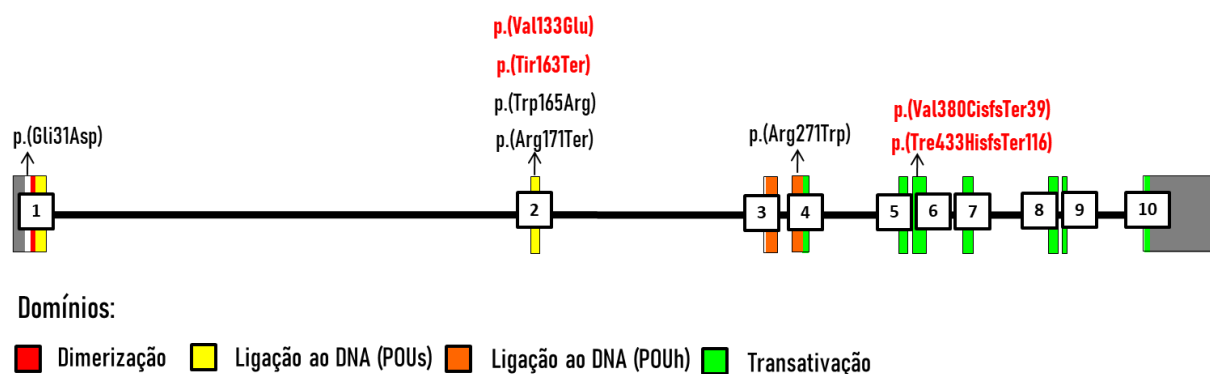
Visto que os testes genéticos ainda não são acessíveis para todos os pacientes com diabetes, novas formas de seleção clínica dos pacientes com suspeita de diabetes monogênico têm sido discutidas e aplicadas, como é o caso da calculadora de MODY, desenvolvida pelos pesquisadores da “University of Exeter Medical School” e da “Royal Devon & Exeter NHS Foundation Trust”. Através da obtenção de dados clínicos do paciente, a calculadora fornece resultados que auxiliam na tomada de decisão do encaminhamento para testes moleculares. Assim, esta ferramenta possibilita uma seleção mais precisa, com melhor custo-benefício. Entretanto, essa calculadora deve ser testada e validada em outras populações já que o estudo se limitou a indivíduos Caucásianos de origem Europeia (272). O resultado obtido pelo nosso estudo inicial demonstrou que a aplicação da calculadora de risco de MODY aumenta a eficiência na detecção de pacientes com GCK-MODY, bem como aumenta a sensibilidade na captação de pacientes HNF1A-MODY, gerando um melhor custo-benefício (269).

O diagnóstico molecular de formas raras de diabetes é de extrema importância pois, além do impacto social na vida do paciente, vimos que o diagnóstico preciso oferece um ótimo custo-benefício, visto que muitos pacientes diminuem a medicação, ou mesmo não necessitam dela. No Brasil, a Diretriz mais atual (2019-2020) da Sociedade Brasileira de Diabetes incluem as formas mais comuns de MODY (MODY1-MODY6) e enfatiza a

importância do olhar clínico para diferenciação entre os jovens com DM do tipo 2 quando comparado aos pacientes com HNF1A-MODY. Além disso, nessa diretriz o tratamento mais adequado para as grávidas com as formas GCK/HNF4A-MODY de diabetes são apresentados (273–275). Ademais, no Brasil há pouco direcionamento de qual procedimento a ser seguido para seleção de pacientes candidatos a serem testados e possivelmente beneficiados pelo diagnóstico genético. Além disso, o diagnóstico molecular ainda não é realizado pelo sistema público de saúde na maioria dos países, incluindo o Brasil. Os estudos genéticos para diagnóstico de pacientes com diabetes monogênico são restritos apenas a laboratórios públicos através da pesquisa clínica ou a empresas privadas. Até o momento, os estudos se baseiam nas frequências das mutações identificadas em genes em outras populações, com componente genético diferente da nossa população, que é altamente miscigenado.

O estudo das formas mais conhecidas - GCK/HNF1A/HNF4A/HNF1B-MODY - permite o tratamento mais direcionado dos pacientes, entretanto, ainda não sabemos a real contribuição dos genes que são descritos como raros ou mesmo de genes ainda não descritos. Neste estudo identificamos variantes possivelmente causais de diabetes em três famílias com formas raras - NEUROD1/PAX4/PDX1-MODY -. Esses relatos de caso de formas raras, com descrição clínica detalhada dos pacientes, são de extrema importância de modo que contribuem com a literatura para que se possa definir um perfil clínico para pacientes com mutações nestes genes, como ocorre com as formas mais comuns de MODY, e futuramente poderão auxiliar na identificação do melhor tratamento para cada subtipo de MODY. Assim, acreditamos que o conhecimento gerado neste estudo das formas raras de diabetes na população brasileira terão grande aplicação clínica e científica.

5. Conclusões

Neste estudo analisamos a presença de variantes patogênicas em genes associados ao diabetes monogênico em uma amostra da população brasileira contribuindo para uma maior compreensão das formas raras do diabetes *mellitus*.

- Dentre os 68 probandos com fenótipo de diabetes monogênico incluídos neste estudo, 34 (50%) apresentaram variantes possivelmente patogênicas em um dos genes estudados. Foram identificados 19 probandos com variantes no gene da glicoquinase (*GCK*) e nove variantes no gene *HNF1A*;
- O rastreamento molecular dos genes *HNF4A*, *HNF1B*, *NEUROD1*, *PAX4*, *PDX1* e *MT-TL1* de 40 probandos possibilitou a identificação de uma variante em cada um destes genes na nossa amostra. Modificações nos genes *KLF11*, *INS*, *KCNJ11* parecem ser causas raras de diabetes *mellitus* do tipo MODY na nossa população, não sendo identificadas;
- Identificamos oito variantes novas, sendo três no gene *GCK* (p.(Tir61Asp), p.(Met115Val), e p.(Asp365GlufsTer95)), quatro no gene *HNF1A* (p.(Val133Glu), p.(Tir163Ter), p.(Val380CisfsTer39) e p.(Tre433HisfsTer116)) e uma no gene *NEUROD1* (p.(Fen256LeufsTer2)). A variante *GCK* p.(Fen423Tir) foi identificada em três probandos (11,53%) e a variante *HNF1A* p.(Arg271Trp) encontrada em dois pacientes (3,77%) da nossa amostra; essas variantes parecem ser frequentes em pacientes brasileiros com MODY. As demais variantes foram identificadas em apenas um probando;
- Identificamos a primeira família com *NEUROD1*-MODY da América Latina, decorrente da variante p.(Fen256LeufsTer2). Descrevemos, pela primeira vez, uma família brasileira com diabetes *mellitus* do tipo *PAX4*-MODY, ocasionado pela variante p.(Arg172Gln). O fenótipo clínico observado na família com *PAX*-MODY variou de sintomas leves a severos. A média da idade de diagnóstico observada foi mais alta do que o esperado para as formas mais comuns de MODY. Além disso, identificamos a variante p.(Glu178Lis) no gene *PDX1* segregando de forma autossômica dominante em uma família brasileira. Com relação à aplicação do diagnóstico molecular no tratamento dos pacientes, dentre sete pacientes com *GCK*-MODY que estavam sob o uso de tratamento farmacológico, seis puderam ser transferidos para o tratamento nutricional. Além disso, dois pacientes com *HNF1A*-MODY foram transferidos do tratamento com injeções de insulina para antidiabéticos orais;

- O estudo de segregação das variantes identificadas neste estudo foi realizado em 19 famílias, sendo onze com GCK-MODY, quatro com HNF1A-MODY, uma família cada com HNF4A-MODY, NEUROD1-MODY, PDX1-MODY e PAX4-MODY; dos 62 familiares testados, 41 indivíduos (82,9%) apresentaram a variante presente no probando e, destes, 34 indivíduos reportaram ter hiperglicemia no momento do recrutamento;
- Neste estudo foram identificadas mutações em 50% da amostra (34/68 pacientes); Dentre os 26 pacientes com perfil clínico de GCK-MODY, 19 (73%) apresentaram modificações no gene *GCK*. Para o grupo HNF1A-MODY composto por 42 pacientes, foram identificadas 9 (21,42%) modificações no gene *HNF1A*. Os genes *HNF4A*, *HNF1B*, *NEUROD1*, *PAX4*, *PDX1* e *MT-TL1* apresentaram uma frequência de 2,5% (1/40) cada. Modificações nos genes *KCNJ11*, *INS* e *KLF11* não foram observadas;
- As variantes raras *PAX4* p.(Arg172Gln) e *PDX1* p.(Glu178Lis) não foram observadas na amostra de controles normoglicêmicos analisada;
- O estudo de análises *in silico* classificou todas as variantes identificadas como possivelmente patogênicas, com exceção da variante *HNF1A* p.(Gli31Asp), classificada como tolerada. Os aminoácidos alterados pelas variantes identificadas neste estudo se mostraram conservados entre os mamíferos;
- Foram desenvolvidos relatórios de pesquisa para os probandos com variantes provavelmente patogênicas e familiares testados.

6. Referências

1. International Diabetes Federation. IDF Diabetes Atlas. Ninth edit. 2019;9:1–176. Available from: www.diabetesatlas.org
2. Collombat P, Hecksher-Sørensen J, Serup P, Mansouri A. Specifying pancreatic endocrine cell fates. *Mech Dev* [Internet]. 2006 Jul;123(7):501–12. Available from: <https://linkinghub.elsevier.com/retrieve/pii/S0925477306000669>
3. Brissova M, Fowler MJ, Nicholson WE, Chu A, Hirshberg B, Harlan DM, et al. Assessment of Human Pancreatic Islet Architecture and Composition by Laser Scanning Confocal Microscopy. *J Histochem Cytochem* [Internet]. 2005 Sep 27;53(9):1087–97. Available from: <http://journals.sagepub.com/doi/10.1369/jhc.5C6684.2005>
4. Komatsu M, Takei M, Ishii H, Sato Y. Glucose-stimulated insulin secretion: A newer perspective. *J Diabetes Investig* [Internet]. 2013 Nov;4(6):511–6. Available from: <http://doi.wiley.com/10.1111/jdi.12094>
5. Khan A, Pessin J. Insulin regulation of glucose uptake: A complex interplay of intracellular signalling pathways [Internet]. Vol. 45, *Diabetologia*. 2002. p. 1475–83. Available from: <http://link.springer.com/10.1007/s00125-002-0974-7>
6. Kohn AD, Summers SA, Birnbaum MJ, Roth RA. Expression of a Constitutively Active Akt Ser/Thr Kinase in 3T3-L1 Adipocytes Stimulates Glucose Uptake and Glucose Transporter 4 Translocation. *J Biol Chem* [Internet]. 1996 Dec;271(49):31372–8. Available from: <https://linkinghub.elsevier.com/retrieve/pii/S0021925819789984>
7. Miller TB, Lerner J. Mechanism of Control of Hepatic Glycogenesis by Insulin. *J Biol Chem* [Internet]. 1973 May;248(10):3483–8. Available from: <https://linkinghub.elsevier.com/retrieve/pii/S0021925819439550>
8. Walton PE, Etherton TD. Stimulation of Lipogenesis by Insulin in Swine Adipose Tissue: Antagonism by Porcine Growth Hormone. *J Anim Sci* [Internet]. 1986 Jun 1;62(6):1584–95. Available from: <https://academic.oup.com/jas/article/62/6/1584-1595/4658655>
9. McTernan PG, Harte AL, Anderson LA, Green A, Smith SA, Holder JC, et al. Insulin and Rosiglitazone Regulation of Lipolysis and Lipogenesis in Human Adipose Tissue In Vitro. *Diabetes* [Internet]. 2002 May 1;51(5):1493–8. Available from: <http://diabetes.diabetesjournals.org/cgi/doi/10.2337/diabetes.51.5.1493>
10. Biolo G, Declan Fleming RY, Wolfe RR. Physiologic hyperinsulinemia stimulates protein synthesis and enhances transport of selected amino acids in human skeletal muscle. *J Clin Invest* [Internet]. 1995 Feb 1;95(2):811–9. Available from: <http://www.jci.org/articles/view/117731>
11. Freychet L, Desplanque N, Zirinis P, Rizkalla SW, Basdevant A, Tchobroutsky G, et al. Effect of Intranasal Glucagon on Blood Glucose Levels in Healthy Subjects and Hypoglycaemic Patients With Insulin-Dependent Diabetes. *Lancet* [Internet]. 1988 Jun;331(8599):1364–6. Available from: <https://linkinghub.elsevier.com/retrieve/pii/S0140673688921812>
12. Röder P V., Wu B, Liu Y, Han W. Pancreatic regulation of glucose homeostasis. *Exp Mol Med* [Internet]. 2016 Mar 11;48(3):e219–e219. Available from: <http://www.nature.com/articles/emm20166>

13. American Diabetes Association. American Diabetes Association. 2. Classification and Diagnosis of Diabetes: Standards of Medical Care in Diabetes—2020. *Diabetes Care* [Internet]. 2020 Jan 20;43(Supplement 1):S14–31. Available from: <http://care.diabetesjournals.org/lookup/doi/10.2337/dc20-S002>
14. World Health Organization & International Diabetes Federation. Definition and diagnosis of diabetes mellitus and intermediate hyperglycaemia : report of a WHO/IDF consultation [Internet]. World Health Organization. Geneva; 2006. p. 1–50. Available from: https://www.who.int/diabetes/publications/diagnosis_diabetes2006/en/
15. International Diabetes Federation and The Fred Hollows Foundation. Diabetes eye health: A guide for health care professionals. Brussels, Belgium Int Diabetes Fed [Internet]. 2015; Available from: www.idf.org/eyecare
16. Yau JWY, Rogers SL, Kawasaki R, Lamoureux EL, Kowalski JW, Bek T, et al. Global Prevalence and Major Risk Factors of Diabetic Retinopathy. *Diabetes Care* [Internet]. 2012 Mar 1;35(3):556–64. Available from: <http://care.diabetesjournals.org/cgi/doi/10.2337/dc11-1909>
17. International Diabetes Federation. Clinical Practice Recommendation on the Diabetic Foot: A guide for health care professionals : Int Diabetes Fed [Internet]. 2017;70. Available from: <https://www.idf.org/about-diabetes/54-our-activities/222-idf-clinical-practice-recommendations-on-the-diabetic-foot.html>
18. Moxey PW, Gogalniceanu P, Hinchliffe RJ, Loftus IM, Jones KJ, Thompson MM, et al. Lower extremity amputations - a review of global variability in incidence. *Diabet Med* [Internet]. 2011 Oct;28(10):1144–53. Available from: <http://doi.wiley.com/10.1111/j.1464-5491.2011.03279.x>
19. Lazzarini PA, Hurn SE, Fernando ME, Jen SD, Kuys SS, Kamp MC, et al. Prevalence of foot disease and risk factors in general inpatient populations: a systematic review and meta-analysis. *BMJ Open* [Internet]. 2015 Nov 23;5(11):e008544. Available from: <http://bmjopen.bmj.com/lookup/doi/10.1136/bmjopen-2015-008544>
20. Pavkov M, Collins A, Coresh J, Nelson R. Kidney Disease in Diabetes. In: Cowie CC, Casagrande SS, Menke A, Cissell MA, Eberhardt MS, Meigs JB, Gregg EW, Knowler WC, Barrett-Connor E, Becker DJ, Brancati FL, Boyko EJ, Herman WH, Howard BV, Narayan KMV, Rewers M, Fradkin JE, Eds. Bethesda, MD N, editor. *Diabetes in America* [Internet]. 3rd ed. National Institutes of Health; 2018. p. 1–84. Available from: <https://linkinghub.elsevier.com/retrieve/pii/B9780128012383958069>
21. Genco RJ, Graziani F, Hasturk H. Effects of periodontal disease on glycemic control, complications, and incidence of diabetes mellitus. *Periodontol 2000* [Internet]. 2020 Jun 8;83(1):59–65. Available from: <https://onlinelibrary.wiley.com/doi/abs/10.1111/prd.12271>
22. Paneni F, Beckman JA, Creager MA, Cosentino F. Diabetes and vascular disease: pathophysiology, clinical consequences, and medical therapy: part I. *Eur Heart J* [Internet]. 2013 Aug 14;34(31):2436–43. Available from: <https://academic.oup.com/eurheartj/article-lookup/doi/10.1093/eurheartj/eh149>
23. Sarwar N, Gao P, Kondapally Seshasai SR, Gobin R, Kaptoge S, Di Angelantonio E, et al. Diabetes mellitus, fasting blood glucose concentration, and risk of vascular disease: A collaborative meta-analysis of 102 prospective studies. *Lancet* [Internet]. 2010;375(9733):2215–22. Available from: [http://dx.doi.org/10.1016/S0140-6736\(10\)60484-9](http://dx.doi.org/10.1016/S0140-6736(10)60484-9)

24. Thomas CC, Philipson LH. Update on Diabetes Classification. *Med Clin North Am* [Internet]. 2015 Jan;99(1):1–16. Available from: <http://dx.doi.org/10.1016/j.mcna.2014.08.015>
25. Xu G, Liu B, Sun Y, Du Y, Snetselaar LG, Hu FB, et al. Prevalence of diagnosed type 1 and type 2 diabetes among US adults in 2016 and 2017: population based study. *BMJ* [Internet]. 2018 Sep 4;362:1–7. Available from: <https://www.bmj.com/lookup/doi/10.1136/bmj.k1497>
26. Atkinson MA, Eisenbarth GS, Michels AW. Type 1 diabetes. *Lancet* [Internet]. 2014 Jan;383(9911):69–82. Available from: [http://dx.doi.org/10.1016/S0140-6736\(13\)60591-7](http://dx.doi.org/10.1016/S0140-6736(13)60591-7)
27. Tan SY, Mei Wong JL, Sim YJ, Wong SS, Mohamed Elhassan SA, Tan SH, et al. Type 1 and 2 diabetes mellitus: A review on current treatment approach and gene therapy as potential intervention. *Diabetes Metab Syndr Clin Res Rev* [Internet]. 2019 Jan;13(1):364–72. Available from: <https://doi.org/10.1016/j.dsx.2018.10.008>
28. Bloomgarden ZT. Type 2 Diabetes in the Young: The evolving epidemic. *Diabetes Care* [Internet]. 2004 Apr 1;27(4):998–1010. Available from: <http://care.diabetesjournals.org/cgi/doi/10.2337/diacare.27.4.998>
29. Fagot-Campagna A. Emergence of Type 2 Diabetes Mellitus in Children: Epidemiological Evidence. *J Pediatr Endocrinol Metab* [Internet]. 2000 Jan 1;13(Supplement):1395–402. Available from: <https://www.degruyter.com/view/j/jpem.2000.13.issue-s6/jpem-2000-s613/jpem-2000-s613.xml>
30. Duncan BB, Cousin E, Naghavi M, Afshin A, França EB, Passos VMDA, et al. The burden of diabetes and hyperglycemia in Brazil: a global burden of disease study 2017. *Popul Health Metr* [Internet]. 2020 Sep 30;18(S1):9. Available from: <http://dx.doi.org/10.1186/s12963-020-00209-0>
31. Ley SH, Schulze MB, Hivert M-F, Meigs JB, Hu FB. Risk Factor for Type 2 Diabetes Mellitus. In: Cowie CC, Casagrande SS, Menke A, Cissell MA, Eberhardt MS, Meigs JB, Gregg EW, Knowler WC, Barrett-Connor E, Becker DJ, Brancati FL, Boyko EJ, Herman WH, Howard BV, Narayan KMV, Rewers M, Fradkin JE, Eds. Bethesda M, editor. *Diabetes in America* [Internet]. 3rd ed. National Institutes of Health; 2015. p. 1–37. Available from: <http://www.ncbi.nlm.nih.gov/pubmed/11333683>
32. Kapoor D. Acute Metabolic Complications in Diabetes. In: Cowie CC, Casagrande SS, Menke A, Cissell MA, Eberhardt MS, Meigs JB, Gregg EW, Knowler WC, Barrett-Connor E, Becker DJ, Brancati FL, Boyko EJ, Herman WH, Howard BV, Narayan KMV, Rewers M, Fradkin JE, Eds. Bethesda M, editor. *Fundamentals of Diabetes* [Internet]. 3rd ed. Jaypee Brothers Medical Publishers (P) Ltd.; 2016. p. 141–141. Available from: <https://www.jaypeedigital.com/book/9789352501519/chapter/ch10>
33. Hod M, Kapur A, Sacks DA, Hadar E, Agarwal M, Di Renzo GC, et al. The International Federation of Gynecology and Obstetrics (FIGO) Initiative on gestational diabetes mellitus: A pragmatic guide for diagnosis, management, and care #. *Int J Gynecol Obstet* [Internet]. 2015 Oct;131:S173–211. Available from: <http://doi.wiley.com/10.1016/S0020-7292%2815%2930033-3>
34. Guariguata L, Linnenkamp U, Beagley J, Whiting DR, Cho NH. Global estimates of the prevalence of hyperglycaemia in pregnancy. *Diabetes Res Clin Pract* [Internet]. 2014 Feb;103(2):176–85. Available from:

<http://dx.doi.org/10.1016/j.diabres.2013.11.003>

35. Immanuel J, Simmons D. Screening and Treatment for Early-Onset Gestational Diabetes Mellitus: a Systematic Review and Meta-analysis. *Curr Diab Rep* [Internet]. 2017 Nov 2;17(11):115. Available from: <http://link.springer.com/10.1007/s11892-017-0943-7>
36. Hedermann G, Hedley PL, Thagaard IN, Krebs L, Ekelund CK, Sørensen TIA, et al. Maternal obesity and metabolic disorders associate with congenital heart defects in the offspring: A systematic review. Xie L, editor. *PLoS One* [Internet]. 2021 May 27;16(5):e0252343. Available from: <https://dx.plos.org/10.1371/journal.pone.0252343>
37. Engineer, Saiyin, Greco, Feng. Say NO to ROS: Their Roles in Embryonic Heart Development and Pathogenesis of Congenital Heart Defects in Maternal Diabetes. *Antioxidants* [Internet]. 2019 Oct 1;8(10):436. Available from: <https://www.mdpi.com/2076-3921/8/10/436>
38. Ornoy A, Reece EA, Pavlinkova G, Kappen C, Miller RK. Effect of maternal diabetes on the embryo, fetus, and children: Congenital anomalies, genetic and epigenetic changes and developmental outcomes. *Birth Defects Res Part C Embryo Today Rev* [Internet]. 2015 Mar;105(1):53–72. Available from: <http://doi.wiley.com/10.1002/bdrc.21090>
39. Bellamy L, Casas J-P, Hingorani AD, Williams D. Type 2 diabetes mellitus after gestational diabetes: a systematic review and meta-analysis. *Lancet* [Internet]. 2009 May;373(9677):1773–9. Available from: [http://dx.doi.org/10.1016/S0140-6736\(09\)60731-5](http://dx.doi.org/10.1016/S0140-6736(09)60731-5)
40. Song C, Lyu Y, Li C, Liu P, Li J, Ma RC, et al. Long-term risk of diabetes in women at varying durations after gestational diabetes: a systematic review and meta-analysis with more than 2 million women. *Obes Rev* [Internet]. 2018 Mar;19(3):421–9. Available from: <http://doi.wiley.com/10.1111/obr.12645>
41. Lowe WL, Scholtens DM, Kuang A, Linder B, Lawrence JM, Lebenthal Y, et al. Hyperglycemia and Adverse Pregnancy Outcome Follow-up Study (HAPO FUS): Maternal Gestational Diabetes Mellitus and Childhood Glucose Metabolism. *Diabetes Care* [Internet]. 2019 Mar;42(3):372–80. Available from: <http://care.diabetesjournals.org/lookup/doi/10.2337/dc18-1646>
42. Pihoker C, Gilliam LK, Ellard S, Dabelea D, Davis C, Dolan LM, et al. Prevalence, Characteristics and Clinical Diagnosis of Maturity Onset Diabetes of the Young Due to Mutations in HNF1A, HNF4A, and Glucokinase: Results From the SEARCH for Diabetes in Youth. *J Clin Endocrinol Metab* [Internet]. 2013 Oct;98(10):4055–62. Available from: <https://academic.oup.com/jcem/article-lookup/doi/10.1210/jc.2013-1279>
43. De Franco E, Flanagan SE, Houghton JAL, Allen HL, MacKay DJG, Temple IK, et al. The effect of early, comprehensive genomic testing on clinical care in neonatal diabetes: An international cohort study. *Lancet* [Internet]. 2015;386(9997):957–63. Available from: [http://dx.doi.org/10.1016/S0140-6736\(15\)60098-8](http://dx.doi.org/10.1016/S0140-6736(15)60098-8)
44. Delvecchio M, Mozzillo E, Salzano G, Iafusco D, Frontino G, Patera PI, et al. Monogenic Diabetes Accounts for 6.3% of Cases Referred to 15 Italian Pediatric Diabetes Centers During 2007 to 2012. *J Clin Endocrinol Metab* [Internet]. 2017 Jun 1;102(6):1826–34. Available from: <https://academic.oup.com/jcem/article/102/6/1826/3001059>

45. Shields BM, Hicks S, Shepherd MH, Colclough K, Hattersley AT, Ellard S. Maturity-onset diabetes of the young (MODY): how many cases are we missing? *Diabetologia* [Internet]. 2010 Dec 25;53(12):2504–8. Available from: <http://link.springer.com/10.1007/s00125-010-1799-4>
46. Althari S, Gloyn AL. When is it MODY? Challenges in the Interpretation of Sequence Variants in MODY Genes. *Rev Diabet Stud* [Internet]. 2015;12(3–4):330–48. Available from: <http://www.soc-bdr.org/content/e4/e887/volRdsVolumes17003/issRdsIssues17253/chpRdsChapters17254/strRdsArticles17309/?preview=preview>
47. Yeung R, Hannah-Shmouni F, K N, MA W. Not quite type 1 or type 2, what now? Review of monogenic, mitochondrial, and syndromic diabetes. *Rev Endocr Metab Disord* [Internet]. 2018;18:1–18. Available from: <http://www.embase.com/search/results?subaction=viewrecord&from=export&id=L622225123%0Ahttp://dx.doi.org/10.1007/s11154-018-9446-3>
48. Yang Y, Chan L. Monogenic Diabetes: What It Teaches Us on the Common Forms of Type 1 and Type 2 Diabetes. *Endocr Rev* [Internet]. 2016 Jun 1;37(3):190–222. Available from: <https://academic.oup.com/edrv/article/37/3/190/2354693>
49. Goto Y, Nonaka I, Horai S. A mutation in the tRNA^{Leu(UUR)} gene associated with the MELAS subgroup of mitochondrial encephalomyopathies. *Nature* [Internet]. 1990 Dec;348(6302):651–3. Available from: <http://www.nature.com/articles/348651a0>
50. Edghill EL, Dix RJ, Flanagan SE, Bingley PJ, Hattersley AT, Ellard S, et al. HLA Genotyping Supports a Nonautoimmune Etiology in Patients Diagnosed With Diabetes Under the Age of 6 Months. *Diabetes* [Internet]. 2006 Jun 1;55(6):1895–8. Available from: <http://diabetes.diabetesjournals.org/cgi/doi/10.2337/db06-0094>
51. Iafusco D, Stazi M, Cotichini R, Cotellessa M, Martinucci M, Mazzella M, et al. Permanent diabetes mellitus in the first year of life. *Diabetologia* [Internet]. 2002 Jun 3;45(6):798–804. Available from: <http://link.springer.com/10.1007/s00125-002-0837-2>
52. Gloyn AL, Pearson ER, Antcliff JF, Proks P, Bruining GJ, Slingerland AS, et al. Activating Mutations in the Gene Encoding the ATP-Sensitive Potassium-Channel Subunit Kir6.2 and Permanent Neonatal Diabetes. *N Engl J Med* [Internet]. 2004 Apr 29;350(18):1838–49. Available from: <http://www.nejm.org/doi/abs/10.1056/NEJMoa032922>
53. Temple IK, Gardner RJ, Mackay DJ, Barber JC, Robinson DO, Shield JP. Transient neonatal diabetes: widening the understanding of the etiopathogenesis of diabetes. *Diabetes* [Internet]. 2000 Aug 1;49(8):1359–66. Available from: <http://journals.sagepub.com/doi/10.1177/0973217920030213>
54. Anderson S, Bankier AT, Barrell BG, de Bruijn MHL, Coulson AR, Drouin J, et al. Sequence and organization of the human mitochondrial genome. *Nature* [Internet]. 1981 Apr;290(5806):457–65. Available from: <http://www.nature.com/articles/290457a0>
55. Larsson N-G, Clayton DA. Molecular Genetic Aspects of Human Mitochondrial Disorders. *Annu Rev Genet* [Internet]. 1995 Dec;29(1):151–78. Available from: <http://www.annualreviews.org/doi/10.1146/annurev.ge.29.120195.001055>
56. Robin ED, Wong R. Mitochondrial DNA molecules and virtual number of mitochondria per cell in mammalian cells. *J Cell Physiol* [Internet]. 1988 Sep;136(3):507–13. Available from: <http://doi.wiley.com/10.1002/jcp.1041360316>

57. Gorman GS, Schaefer AM, Ng Y, Gomez N, Blakely EL, Alston CL, et al. Prevalence of nuclear and mitochondrial DNA mutations related to adult mitochondrial disease. *Ann Neurol* [Internet]. 2015 May 28;77(5):753–9. Available from: <https://onlinelibrary.wiley.com/doi/10.1002/ana.24362>
58. Hutchison CA, Newbold JE, Potter SS, Edgell MH. Maternal inheritance of mammalian mitochondrial DNA. *Nature* [Internet]. 1974 Oct;251(5475):536–8. Available from: <http://www.nature.com/articles/251536a0>
59. Nesbitt V, Pitceathly RDS, Turnbull DM, Taylor RW, Sweeney MG, Mudanohwo EE, et al. The UK MRC Mitochondrial Disease Patient Cohort Study: clinical phenotypes associated with the m.3243A>G mutation--implications for diagnosis and management. *J Neurol Neurosurg Psychiatry* [Internet]. 2013 Aug 1;84(8):936–8. Available from: <http://jnnp.bmj.com/cgi/doi/10.1136/jnnp-2012-303528>
60. Van den Ouweland JMW, Lemkes HHPJ, Trembath RC, Ross R, Velho G, Cohen D, et al. Maternally inherited diabetes and deafness is a distinct subtype of diabetes and associates with a single point mutation in the mitochondrial tRNA Leu(UUR) gene. *Diabetes* [Internet]. 1994 Jun 1;43(6):746–51. Available from: <http://diabetes.diabetesjournals.org/cgi/doi/10.2337/diab.43.6.746>
61. Greaves LC, Yu-Wai-Man P, Blakely EL, Krishnan KJ, Beadle NE, Kerin J, et al. Mitochondrial DNA Defects and Selective Extraocular Muscle Involvement in CPEO. *Investig Ophthalmology Vis Sci* [Internet]. 2010 Jul 1;51(7):3340. Available from: <http://iovs.arvojournals.org/article.aspx?doi=10.1167/iovs.09-4659>
62. Manwaring N, Jones MM, Wang JJ, Rohtchina E, Howard C, Mitchell P, et al. Population prevalence of the MELAS A3243G mutation. *Mitochondrion* [Internet]. 2007 May;7(3):230–3. Available from: <https://linkinghub.elsevier.com/retrieve/pii/S1567724907000037>
63. Elliott HR, Samuels DC, Eden JA, Relton CL, Chinnery PF. Pathogenic Mitochondrial DNA Mutations Are Common in the General Population. *Am J Hum Genet* [Internet]. 2008 Aug;83(2):254–60. Available from: <https://linkinghub.elsevier.com/retrieve/pii/S0002929708004023>
64. McFarland R, Taylor RW, Turnbull DM. A neurological perspective on mitochondrial disease. *Lancet Neurol* [Internet]. 2010;9(8):829–40. Available from: [http://dx.doi.org/10.1016/S1474-4422\(10\)70116-2](http://dx.doi.org/10.1016/S1474-4422(10)70116-2)
65. Grady JP, Pickett SJ, Ng YS, Alston CL, Blakely EL, Hardy SA, et al. mtDNA heteroplasmy level and copy number indicate disease burden in m.3243A>G mitochondrial disease. *EMBO Mol Med* [Internet]. 2018 Jun 7;10(6):1–13. Available from: <https://onlinelibrary.wiley.com/doi/10.15252/emmm.201708262>
66. Boggan RM, Lim A, Taylor RW, McFarland R, Pickett SJ. Resolving complexity in mitochondrial disease: Towards precision medicine. *Mol Genet Metab* [Internet]. 2019;128(1–2):19–29. Available from: <https://doi.org/10.1016/j.ymgme.2019.09.003>
67. Whittaker RG, Schaefer AM, McFarland R, Taylor RW, Walker M, Turnbull DM. Prevalence and progression of diabetes in mitochondrial disease. *Diabetologia* [Internet]. 2007 Sep 4;50(10):2085–9. Available from: <http://link.springer.com/10.1007/s00125-007-0779-9>
68. Guillausseau P, Dubois-Laforgue D, Massin P, Laloi-Michelin M, Bellanné-Chantelot C, Gin H, et al. Heterogeneity of diabetes phenotype in patients with 3243 bp mutation

- of mitochondrial DNA (Maternally Inherited Diabetes and Deafness or MIDD). *Diabetes Metab* [Internet]. 2004 Apr;30(2):181–6. Available from: <https://linkinghub.elsevier.com/retrieve/pii/S1262363607701052>
69. Schaefer AM, Walker M, Turnbull DM, Taylor RW. Endocrine disorders in mitochondrial disease. *Mol Cell Endocrinol* [Internet]. 2013;379(1–2):2–11. Available from: <http://dx.doi.org/10.1016/j.mce.2013.06.004>
 70. Goto Y, Koga Y, Horai S, Nonaka I. Chronic progressive external ophthalmoplegia: A correlative study of mitochondrial DNA deletions and their phenotypic expression in muscle biopsies. *J Neurol Sci* [Internet]. 1990 Dec;100(1–2):63–9. Available from: <https://linkinghub.elsevier.com/retrieve/pii/0022510X9090014E>
 71. Sciacco M, Bonilla E, Schon EA, DiMauro S, Moraes CT. Distribution of wild-type and common deletion forms of mtDNA in normal and respiration-deficient muscle fibers from patients with mitochondrial myopathy. *Hum Mol Genet* [Internet]. 1994 Jan 1;3(1):13–9. Available from: <https://academic.oup.com/hmg/article-lookup/doi/10.1093/hmg/3.1.13>
 72. Yamagata K, Furuta H, Oda N, Kaisaki PJ, Menzel S, Cox NJ, et al. Mutations in the hepatocyte nuclear factor-4 α gene in maturity-onset diabetes of the young (MODY1). *Nature* [Internet]. 1996 Dec;384(6608):458–60. Available from: <http://www.nature.com/articles/384458a0>
 73. Froguel P, Zouali H, Vionnet N, Velho G, Vaxillaire M, Sun F, et al. Familial Hyperglycemia Due to Mutations in Glucokinase -- Definition of a Subtype of Diabetes Mellitus. *N Engl J Med* [Internet]. 1993 Mar 11;328(10):697–702. Available from: <http://www.nejm.org/doi/abs/10.1056/NEJM199303113281005>
 74. Horikawa Y, Iwasaki N, Hara M, Furuta H, Hinokio Y, Cockburn BN, et al. Mutation in hepatocyte nuclear factor-1 β gene (TCF2) associated with MODY. *Nat Genet* [Internet]. 1997 Dec;17(4):384–5. Available from: <http://www.nature.com/articles/ng1297-384>
 75. Fajans SS. Maturity-onset diabetes of the young (MODY). *Diabetes / Metab Rev* [Internet]. 1989 Nov;5(7):579–606. Available from: <http://doi.wiley.com/10.1002/dmr.5610050705>
 76. Stoffers DA, Zinkin NT, Stanojevic V, Clarke WL, Habener JF. Pancreatic agenesis attributable to a single nucleotide deletion in the human IPF1 gene coding sequence. *Nat Genet* [Internet]. 1997 Jan;15(1):106–10. Available from: <http://www.nature.com/articles/ng0197-106>
 77. Edghill EL, Bingham C, Slingerland AS, Minton JAL, Noordam C, Ellard S, et al. Hepatocyte nuclear factor-1 beta mutations cause neonatal diabetes and intrauterine growth retardation: support for a critical role of HNF-1 β in human pancreatic development. *Diabet Med* [Internet]. 2006 Dec;23(12):1301–6. Available from: <http://doi.wiley.com/10.1111/j.1464-5491.2006.01999.x>
 78. McCarthy MI, Hattersley AT. Learning From Molecular Genetics: Novel Insights Arising From the Definition of Genes for Monogenic and Type 2 Diabetes. *Diabetes* [Internet]. 2008 Nov 1;57(11):2889–98. Available from: <http://diabetes.diabetesjournals.org/cgi/doi/10.2337/db08-0343>
 79. Malecki MT, Jhala US, Antonellis A, Fields L, Doria A, Orban T, et al. Mutations in NEUROD1 are associated with the development of type 2 diabetes mellitus. *Nat Genet* [Internet]. 1999 Nov;23(3):323–8. Available from:

- <http://www.ncbi.nlm.nih.gov/pubmed/10545951>
80. Neve B, Fernandez-Zapico ME, Ashkenazi-Katalan V, Dina C, Hamid YH, Joly E, et al. Role of transcription factor KLF11 and its diabetes-associated gene variants in pancreatic beta cell function. *Proc Natl Acad Sci [Internet]*. 2005 Mar 29;102(13):4807–12. Available from: <http://www.pnas.org/cgi/doi/10.1073/pnas.0409177102>
 81. Torsvik J, Johansson S, Johansen A, Ek J, Minton J, Ræder H, et al. Mutations in the VNTR of the carboxyl-ester lipase gene (CEL) are a rare cause of monogenic diabetes. *Hum Genet [Internet]*. 2010 Jan 17;127(1):55–64. Available from: <http://link.springer.com/10.1007/s00439-009-0740-8>
 82. Plengvidhya N, Kooptiwut S, Songtawee N, Doi A, Furuta H, Nishi M, et al. PAX4 Mutations in Thais with Maturity Onset Diabetes of the Young. *J Clin Endocrinol Metab [Internet]*. 2007 Jul;92(7):2821–6. Available from: <https://academic.oup.com/jcem/article-lookup/doi/10.1210/jc.2006-1927>
 83. Molven A, Ringdal M, Nordbo AM, Raeder H, Stoy J, Lipkind GM, et al. Mutations in the Insulin Gene Can Cause MODY and Autoantibody-Negative Type 1 Diabetes. *Diabetes [Internet]*. 2008 Apr 1;57(4):1131–5. Available from: <http://diabetes.diabetesjournals.org/cgi/doi/10.2337/db07-1467>
 84. Edghill EL, Flanagan SE, Patch A-M, Boustred C, Parrish A, Shields B, et al. Insulin Mutation Screening in 1,044 Patients With Diabetes: Mutations in the INS Gene Are a Common Cause of Neonatal Diabetes but a Rare Cause of Diabetes Diagnosed in Childhood or Adulthood. *Diabetes [Internet]*. 2008 Apr 1;57(4):1034–42. Available from: <http://diabetes.diabetesjournals.org/cgi/doi/10.2337/db07-1405>
 85. Borowiec M, Liew CW, Thompson R, Boonyasrisawat W, Hu J, Mlynarski WM, et al. Mutations at the BLK locus linked to maturity onset diabetes of the young and beta-cell dysfunction. *Proc Natl Acad Sci [Internet]*. 2009;106(34):14460–5. Available from: <http://www.pnas.org/cgi/doi/10.1073/pnas.0906474106>
 86. Bowman P, Flanagan SE, Edghill EL, Damhuis A, Shepherd MH, Paisey R, et al. Heterozygous ABCC8 mutations are a cause of MODY. *Diabetologia [Internet]*. 2012 Jan 12;55(1):123–7. Available from: <http://link.springer.com/10.1007/s00125-011-2319-x>
 87. Bonnefond A, Philippe J, Durand E, Dechaume A, Huyvaert M, Montagne L, et al. Whole-Exome Sequencing and High Throughput Genotyping Identified KCNJ11 as the Thirteenth MODY Gene. Brusgaard K, editor. *PLoS One [Internet]*. 2012 Jun 11;7(6):e37423. Available from: <https://dx.plos.org/10.1371/journal.pone.0037423>
 88. Prudente S, Jungtrakoon P, Marucci A, Ludovico O, Buranasupkajorn P, Mazza T, et al. Loss-of-Function Mutations in APPL1 in Familial Diabetes Mellitus. *Am J Hum Genet [Internet]*. 2015 Jul;97(1):177–85. Available from: <http://dx.doi.org/10.1016/j.ajhg.2015.05.011>
 89. Patel KA, Kettunen J, Laakso M, Stančáková A, Laver TW, Colclough K, et al. Heterozygous RFX6 protein truncating variants are associated with MODY with reduced penetrance. *Nat Commun [Internet]*. 2017 Dec 12;8(1):888. Available from: <http://www.nature.com/articles/s41467-017-00895-9>
 90. Laver T, Wakeling M, Knox, O. Redefining the pathogenicity of Maturity Onset Diabetes of the Young (MODY) genes: BLK P and K do not cause M, De-Franco O, Flanagan S, Colclough K, et al. *Young Diabetologist and Endocrinologist Forum*

- Trainee Award. In: Redefining the pathogenicity of Maturity Onset Diabetes of the Young (MODY) genes: BLK, PAX4 and KLF11 do not cause MODY. 2018. p. P112.
91. Firdous P, Nissar K, Ali S, Ganai BA, Shabir U, Hassan T, et al. Genetic Testing of Maturity-Onset Diabetes of the Young Current Status and Future Perspectives. *Front Endocrinol (Lausanne)* [Internet]. 2018 May 17;9(MAY):1–13. Available from: <http://journal.frontiersin.org/article/10.3389/fendo.2018.00253/full>
 92. Jang KM. Maturity-onset diabetes of the young: update and perspectives on diagnosis and treatment. *Yeungnam Univ J Med* [Internet]. 2020 Jan 31;37(1):13–21. Available from: <https://www.dovepress.com/maturity-onset-diabetes-of-the-young-mody-current-perspectives-on-diag-peer-reviewed-article-DMSO>
 93. Zhang H, Colclough K, Gloyn AL, Pollin TI. Monogenic diabetes: a gateway to precision medicine in diabetes. *J Clin Invest* [Internet]. 2021 Feb 1;131(3):1–14. Available from: <https://www.jci.org/articles/view/142244>
 94. Concannon P, Rich SS, Nepom GT. Genetics of Type 1A Diabetes. *N Engl J Med* [Internet]. 2009 Apr 16;360(16):1646–54. Available from: <http://www.nejm.org/doi/abs/10.1056/NEJMc091064>
 95. Noble JA, Valdes AM, Varney MD, Carlson JA, Moonsamy P, Fear AL, et al. HLA Class I and Genetic Susceptibility to Type 1 Diabetes: Results From the Type 1 Diabetes Genetics Consortium. *Diabetes* [Internet]. 2010 Nov 1;59(11):2972–9. Available from: <http://diabetes.diabetesjournals.org/cgi/doi/10.2337/db10-0699>
 96. Florez JC, Udler MS, Hanson RL. Genetics of type 2 Diabetes. In: Cowie CC, Casagrande SS, Menke A, Cissell MA, Eberhardt MS, Meigs JB, Gregg EW, Knowler WC, Barrett-Connor E, Becker DJ, Brancati FL, Boyko EJ, Herman WH, Howard BV, Narayan KMV, Rewers M, Fradkin JE, Eds. Bethesda M, editor. *Diabetes in America*. 3rd ed. National Institutes of Health; 2018. p. 1–25.
 97. Vaxillaire M, Froguel P. Monogenic diabetes: Implementation of translational genomic research towards precision medicine. *J Diabetes* [Internet]. 2016 Nov;8(6):782–95. Available from: <http://doi.wiley.com/10.1111/1753-0407.12446>
 98. Timsit J, Saint-Martin C, Dubois-Laforgue D, Bellanné-Chantelot C. Searching for Maturity-Onset Diabetes of the Young (MODY): When and What for? *Can J Diabetes* [Internet]. 2016 Oct;40(5):455–61. Available from: <http://dx.doi.org/10.1016/j.jcjd.2015.12.005>
 99. Osbak KK, Colclough K, Saint-Martin C, Beer NL, Bellanné-Chantelot C, Ellard S, et al. Update on mutations in glucokinase (GCK), which cause maturity-onset diabetes of the young, permanent neonatal diabetes, and hyperinsulinemic hypoglycemia. *Hum Mutat* [Internet]. 2009;30(11):1512–26. Available from: <https://onlinelibrary.wiley.com/doi/abs/10.1002/humu.21110>
 100. Ellard S, Thomas K, Edghill EL, Owens M, Ambye L, Cropper J, et al. Partial and whole gene deletion mutations of the GCK and HNF1A genes in maturity-onset diabetes of the young. *Diabetologia* [Internet]. 2007 Oct 1;50(11):2313–7. Available from: <http://link.springer.com/10.1007/s00125-007-0798-6>
 101. Garin I, Rica I, Estalella I, Oyarzabal M, Rodríguez-Rigual M, Pedro JIS, et al. Haploinsufficiency at GCK gene is not a frequent event in MODY2 patients. *Clin Endocrinol (Oxf)* [Internet]. 2008 Jun;68(6):873–8. Available from: <http://doi.wiley.com/10.1111/j.1365-2265.2008.03214.x>

102. Birkebæk NH, Sørensen JS, Vikre-Jørgensen J, Jensen PKA, Pedersen O, Hansen T. A De Novo Whole GCK Gene Deletion Not Detected by Gene Sequencing, in a Boy with Phenotypic GCK Insufficiency. *Case Rep Genet* [Internet]. 2011;2011(Dm):1–3. Available from: <http://www.hindawi.com/journals/crig/2011/768610/>
103. Dotto RP, Giuffrida FMA, Franco L, Mathez ALG, Weinert LS, Silveiro SP, et al. Unexpected finding of a whole HNF1B gene deletion during the screening of rare MODY types in a series of Brazilian patients negative for GCK and HNF1A mutations. *Diabetes Res Clin Pract* [Internet]. 2016 Jun;116:100–4. Available from: <http://dx.doi.org/10.1016/j.diabres.2016.04.035>
104. Giuffrida FMA, Moises RS, Weinert LS, Calliari LE, Manna T Della, Dotto RP, et al. Maturity-onset diabetes of the young (MODY) in Brazil: Establishment of a national registry and appraisal of available genetic and clinical data. *Diabetes Res Clin Pract* [Internet]. 2017;123:134–42. Available from: <http://linkinghub.elsevier.com/retrieve/pii/S016882271630376X%5Cnhttp://www.ncbi.nlm.nih.gov/pubmed/28012402>
105. Froguel P, Vaxillaire M, Sun F, Velho G, Zouali H, Butel MO, et al. Close linkage of glucokinase locus on chromosome 7p to early-onset non-insulin-dependent diabetes mellitus. *Nature* [Internet]. 1992 Mar;356(6365):162–4. Available from: <http://www.nature.com/articles/356162a0>
106. Stoffel M, Froguel P, Takeda J, Zouali H, Vionnet N, Nishi S, et al. Human glucokinase gene: isolation, characterization, and identification of two missense mutations linked to early-onset non-insulin-dependent (type 2) diabetes mellitus. *Proc Natl Acad Sci* [Internet]. 1992 Aug 15;89(16):7698–702. Available from: <http://www.pnas.org/content/pnas/89/16/7698.full.pdf>
107. Griffin LD, Gelb BD, Wheeler DA, Davison D, Adams V, McCabe ERB. Mammalian hexokinase 1: Evolutionary conservation and structure to function analysis. *Genomics* [Internet]. 1991 Dec;11(4):1014–24. Available from: <https://linkinghub.elsevier.com/retrieve/pii/088875439190027C>
108. Matschinsky FM. Glucokinase as glucose sensor and metabolic signal generator in pancreatic beta-cells and hepatocytes. *Diabetes* [Internet]. 1990 Jun 1;39(6):647–52. Available from: <http://diabetes.diabetesjournals.org/cgi/doi/10.2337/diabetes.39.6.647>
109. Lenzen S, Panten U. Signal recognition by pancreatic B-cells. *Biochem Pharmacol* [Internet]. 1988 Feb;37(3):371–8. Available from: <https://linkinghub.elsevier.com/retrieve/pii/0006295288902018>
110. Giroix MH, Sener A, Pipeleers DG, Malaisse WJ. Hexose metabolism in pancreatic islets. Inhibition of hexokinase. *Biochem J* [Internet]. 1984 Oct 15;223(2):447–53. Available from: <https://portlandpress.com/biochemj/article/223/2/447/18939/Hexose-metabolism-in-pancreatic-islets-Inhibition>
111. Schuit F, Moens K, Heimberg H, Pipeleers D. Cellular Origin of Hexokinase in Pancreatic Islets. *J Biol Chem* [Internet]. 1999 Nov 12;274(46):32803–9. Available from: <http://www.jbc.org/lookup/doi/10.1074/jbc.274.46.32803>
112. Cook DL, Hales N. Intracellular ATP directly blocks K⁺ channels in pancreatic B-cells. *Nature* [Internet]. 1984 Sep;311(5983):271–3. Available from: <http://www.nature.com/articles/311271a0>
113. Ashcroft FM, Harrison DE, Ashcroft SJH. Glucose induces closure of single potassium channels in isolated rat pancreatic β -cells. *Nature* [Internet]. 1984 Nov;312(5993):446–

8. Available from: <http://www.nature.com/articles/312446a0>
114. Seino S. Cell signalling in insulin secretion: the molecular targets of ATP, cAMP and sulfonylurea. *Diabetologia* [Internet]. 2012 Aug 4;55(8):2096–108. Available from: <http://link.springer.com/10.1007/s00125-012-2562-9>
115. Al-Hasani H. Two Birds with One Stone: Novel Glucokinase Activator Stimulates Glucose-Induced Pancreatic Insulin Secretion and Augments Hepatic Glucose Metabolism. *Mol Interv* [Internet]. 2003 Oct 1;3(7):367–70. Available from: <http://molinterv.aspetjournals.org/cgi/doi/10.1124/mi.3.7.367>
116. Lenzen S. A Fresh View of Glycolysis and Glucokinase Regulation: History and Current Status. *J Biol Chem* [Internet]. 2014 May 2;289(18):12189–94. Available from: <http://www.jbc.org/lookup/doi/10.1074/jbc.R114.557314>
117. Baltrusch S, Francini F, Lenzen S, Tiedge M. Interaction of Glucokinase With the Liver Regulatory Protein Is Conferred by Leucine-Asparagine Motifs of the Enzyme. *Diabetes* [Internet]. 2005 Oct 1;54(10):2829–37. Available from: <http://diabetes.diabetesjournals.org/cgi/doi/10.2337/diabetes.54.10.2829>
118. Massa L, Baltrusch S, Okar DA, Lange AJ, Lenzen S, Tiedge M. Interaction of 6-Phosphofructo-2-Kinase/Fructose-2,6-Bisphosphatase (PFK-2/FBPase-2) With Glucokinase Activates Glucose Phosphorylation and Glucose Metabolism in Insulin-Producing Cells. *Diabetes* [Internet]. 2004 Apr 1;53(4):1020–9. Available from: <http://diabetes.diabetesjournals.org/cgi/doi/10.2337/diabetes.53.4.1020>
119. Van Schaftingen E, Detheux M, Da Cunha MV. Short-term control of glucokinase activity: role of a regulatory protein. *FASEB J* [Internet]. 1994 Apr;8(6):414–9. Available from: <https://onlinelibrary.wiley.com/doi/abs/10.1096/fasebj.8.6.8168691>
120. Van Schaftingen E, Vandercammen A, Detheux M, Davies DR. The regulatory protein of liver glucokinase. *Adv Enzyme Regul* [Internet]. 1992 Jan;32(C):133–48. Available from: <https://linkinghub.elsevier.com/retrieve/pii/006525719290013P>
121. Van Schaftingen E. A protein from rat liver confers to glucokinase the property of being antagonistically regulated by fructose 6-phosphate and fructose 1-phosphate. *Eur J Biochem* [Internet]. 1989 Jan;179(1):179–84. Available from: <https://linkinghub.elsevier.com/retrieve/pii/0261561490901115>
122. Matschinsky FM. Regulation of Pancreatic B-Cell Glucokinase: From Basics to Therapeutics. *Diabetes* [Internet]. 2002 Dec 1;51(Supplement 3):S394–404. Available from: http://diabetes.diabetesjournals.org/content/51/suppl_3/S394
123. Byrne MM, Sturis J, Clément K, Vionnet N, Pueyo ME, Stoffel M, et al. Insulin secretory abnormalities in subjects with hyperglycemia due to glucokinase mutations. *J Clin Invest* [Internet]. 1994 Mar 1;93(3):1120–30. Available from: <https://www.ncbi.nlm.nih.gov/ezproxy.libraries.wright.edu/pmc/articles/PMC294056/pdf/jcinvest00032-0210.pdf>
124. Gloyn AL, Odili S, Buettger C, Njolstad PR, Shiota C, Magnuson MA, et al. Glucokinase and the Regulation of Blood Sugar. In: *Glucokinase and Glycemic Disease: From Basics to Novel Therapeutics* [Internet]. Basel: KARGER; 2004. p. 92–109. Available from: <https://www.karger.com/Article/FullText/79009>
125. Velho G, Petersen KF, Perseghin G, Hwang JH, Rothman DL, Pueyo ME, et al. Impaired hepatic glycogen synthesis in glucokinase-deficient (MODY-2) subjects. *J Clin Invest* [Internet]. 1996 Oct 15;98(8):1755–61. Available from:

<http://www.jci.org/articles/view/118974>

126. Njolstad PR, Sagen J V, Bjorkhaug L, Odili S, Shehadeh N, Bakry D, et al. Permanent Neonatal Diabetes Caused by Glucokinase Deficiency: Inborn Error of the Glucose-Insulin Signaling Pathway. *Diabetes* [Internet]. 2003 Nov 1;52(11):2854–60. Available from: <http://diabetes.diabetesjournals.org/content/52/11/2854.abstract>
127. Njølstad P, Søvik O, Cuesta-Muñoz A, Bjørkhaug L, Massa O, Barbetti F, et al. Neonatal Diabetes Mellitus Due To Complete Glucokinase Deficiency. *N Engl J Med* [Internet]. 2001;344(21):1588–92. Available from: <http://www.nejm.org/doi/abs/10.1056/NEJM200105243442104>
128. Christesen HBT, Tribble ND, Molven A, Siddiqui J, Sandal T, Brusgaard K, et al. Activating glucokinase (GCK) mutations as a cause of medically responsive congenital hyperinsulinism: prevalence in children and characterisation of a novel GCK mutation. *Eur J Endocrinol* [Internet]. 2008 Jul;159(1):27–34. Available from: <https://eje.bioscientifica.com/view/journals/eje/159/1/27.xml>
129. Cuesta-Munoz AL, Huopio H, Otonkoski T, Gomez-Zumaquero JM, Nanto-Salonen K, Rahier J, et al. Severe Persistent Hyperinsulinemic Hypoglycemia due to a De Novo Glucokinase Mutation. *Diabetes* [Internet]. 2004 Aug 1;53(8):2164–8. Available from: <http://diabetes.diabetesjournals.org/cgi/doi/10.2337/diabetes.53.8.2164>
130. Sternisha SM, Miller BG. Molecular and cellular regulation of human glucokinase. *Arch Biochem Biophys* [Internet]. 2019 Mar;663(12):199–213. Available from: <https://linkinghub.elsevier.com/retrieve/pii/S0003986118310166>
131. Prisco F, Iafusco D, Franzese A, Sulli N, Barbetti F. MODY 2 presenting as neonatal hyperglycaemia: a need to reshape the definition of “neonatal diabetes”? *Diabetologia* [Internet]. 2000 Oct 2;43(10):1331–2. Available from: <http://link.springer.com/10.1007/s001250051531>
132. Steele AM, Wensley KJ, Ellard S, Murphy R, Shepherd M, Colclough K, et al. Use of HbA1c in the Identification of Patients with Hyperglycaemia Caused by a Glucokinase Mutation: Observational Case Control Studies. *Lin X (Erick)*, editor. *PLoS One* [Internet]. 2013 Jun 14;8(6):e65326. Available from: <https://dx.plos.org/10.1371/journal.pone.0065326>
133. Velho G, Blanché H, Vaxillaire M, Bellanné-Chantelot C, Pardini VC, Timsit J, et al. Identification of 14 new glucokinase mutations and description of the clinical profile of 42 MODY-2 families. *Diabetologia* [Internet]. 1997 Jan 28;40(2):217–24. Available from: <http://ovidsp.ovid.com/ovidweb.cgi?T=JS&PAGE=reference&D=emed7&NEWS=N&AN=27060296>
134. McDonald TJ, Ellard S. Maturity onset diabetes of the young: identification and diagnosis. *Ann Clin Biochem An Int J Biochem Lab Med* [Internet]. 2013 Sep 1;50(5):403–15. Available from: <http://acb.sagepub.com/lookup/doi/10.1177/0004563213483458>
135. Petruzelkova L, Dusatkova P, Cinek O, Sumnik Z, Pruhova S, Hradsky O, et al. Substantial proportion of MODY among multiplex families participating in a Type 1 diabetes prediction programme. *Diabet Med* [Internet]. 2016 Dec;33(12):1712–6. Available from: <http://doi.wiley.com/10.1111/dme.13043>
136. Stride A, Shields B, Gill-Carey O, Chakera AJ, Colclough K, Ellard S, et al. Cross-sectional and longitudinal studies suggest pharmacological treatment used in patients

- with glucokinase mutations does not alter glycaemia. *Diabetologia* [Internet]. 2014 Jan 4;57(1):54–6. Available from: <http://link.springer.com/10.1007/s00125-013-3075-x>
137. Spyer G, Macleod KM, Shepherd M, Ellard S, Hattersley AT. Pregnancy outcome in patients with raised blood glucose due to a heterozygous glucokinase gene mutation. *Diabet Med* [Internet]. 2009;26(1):14–8. Available from: <https://europepmc.org/article/med/19125755>
 138. Spyer G, Hattersley AT, Sykes JE, Sturley RH, MacLeod KM. Influence of maternal and fetal glucokinase mutations in gestational diabetes. *Am J Obstet Gynecol* [Internet]. 2001 Jul;185(1):240–1. Available from: <https://linkinghub.elsevier.com/retrieve/pii/S0002937801390749>
 139. Caswell RC, Snowsill T, Houghton JAL, Chakera AJ, Shepherd MH, Laver TW, et al. Noninvasive Fetal Genotyping by Droplet Digital PCR to Identify Maternally Inherited Monogenic Diabetes Variants. *Clin Chem* [Internet]. 2020 Jul 1;66(7):958–65. Available from: <https://academic.oup.com/clinchem/article/66/7/958/5856842>
 140. Colclough K, Bellanne-Chantelot C, Saint-Martin C, Flanagan SE, Ellard S. Mutations in the Genes Encoding the Transcription Factors Hepatocyte Nuclear Factor 1 Alpha and 4 Alpha in Maturity-Onset Diabetes of the Young and Hyperinsulinemic Hypoglycemia [Internet]. Vol. 34, *Human Mutation*. 2013. 669–685 p. Available from: <https://onlinelibrary.wiley.com/doi/abs/10.1002/humu.22279>
 141. Horikawa Y, Enya M, Fushimi N, Fushimi Y, Takeda J. Screening of diabetes of youth for hepatocyte nuclear factor 1 mutations: clinical phenotype of HNF1 β -related maturity-onset diabetes of the young and HNF1 α -related maturity-onset diabetes of the young in Japanese. *Diabet Med* [Internet]. 2014 Jun;31(6):721–7. Available from: <http://doi.wiley.com/10.1111/dme.12416>
 142. Mendel DB, Crabtree GR. HNF- 1 , a Member of a Novel Class of Dimerizing Homeodomain Protein. *J Biol Chem* [Internet]. 1991;266(2):677–80. Available from: [https://www.jbc.org/article/S0021-9258\(17\)35222-5/pdf](https://www.jbc.org/article/S0021-9258(17)35222-5/pdf)
 143. Chi Y-I, Frantz JD, Oh B-C, Hansen L, Dhe-Paganon S, Shoelson SE. Diabetes Mutations Delineate an Atypical POU Domain in HNF-1 α . *Mol Cell* [Internet]. 2002 Nov;10(5):1129–37. Available from: <https://linkinghub.elsevier.com/retrieve/pii/S1097276502007049>
 144. Rose RB, Bayle JH, Endrizzi JA, Cronk JD, Crabtree GR, Alber T. Structural basis of dimerization, coactivator recognition and MODY3 mutations in HNF-1 α . *Nat Struct Biol* [Internet]. 2000;7(9):744–8. Available from: https://www.nature.com/articles/nsb0900_744
 145. Vaxillaire M, Abderrahmani A, Boutin P, Bailleul B, Froguel P, Yaniv M, et al. Anatomy of a homeoprotein revealed by the analysis of human MODY3 mutations. *J Biol Chem* [Internet]. 1999;274(50):35639–46. Available from: <http://www.jbc.org/lookup/doi/10.1074/jbc.274.50.35639>
 146. Bellanne-Chantelot C, Carette C, Riveline J-P, Valero R, Gautier J-F, Larger E, et al. The Type and the Position of HNF1A Mutation Modulate Age at Diagnosis of Diabetes in Patients with Maturity-Onset Diabetes of the Young (MODY)-3. *Diabetes* [Internet]. 2008 Feb 1;57(2):503–8. Available from: <http://diabetes.diabetesjournals.org/cgi/doi/10.2337/db07-0859>
 147. Klupa T, Warram JH, Antonellis A, Pezzolesi M, Nam M, Malecki MT, et al. Determinants of the Development of Diabetes (Maturity-Onset Diabetes of the Young-

- 3) in Carriers of HNF-1 Mutations: Evidence for parent-of-origin effect. *Diabetes Care* [Internet]. 2002 Dec 1;25(12):2292–301. Available from: <http://care.diabetesjournals.org/cgi/doi/10.2337/diacare.25.12.2292>
148. Shepherd M, Sparkes AC, Hattersley AT. Genetic testing in maturity onset diabetes of the young (MODY): a new challenge for the diabetic clinic. *Pract Diabetes Int* [Internet]. 2001 Jan;18(1):16–21. Available from: <http://doi.wiley.com/10.1002/pdi.108>
 149. Soutoglou E, Papafotiou G, Katrakili N, Talianidis I. Transcriptional Activation by Hepatocyte Nuclear Factor-1 Requires Synergism between Multiple Coactivator Proteins. *J Biol Chem* [Internet]. 2000 Apr 28;275(17):12515–20. Available from: <http://www.jbc.org/lookup/doi/10.1074/jbc.275.17.12515>
 150. Odom DT, Zizlsperger N, Gordon DB, Bell GW, Rinaldi NJ, Murray HL, et al. Control of Pancreas and Liver Gene Expression by HNF Transcription Factors. *Science (80-)* [Internet]. 2004 Feb 27;303(5662):1378–81. Available from: <https://academic.oup.com/jcem/article-lookup/doi/10.1210/jcem-10-10-1361>
 151. Lau HH, Ng NHJ, Loo LSW, Jasmen JB, Teo AKK. The molecular functions of hepatocyte nuclear factors – In and beyond the liver. *J Hepatol* [Internet]. 2018 May;68(5):1033–48. Available from: <https://doi.org/10.1016/j.jhep.2017.11.026>
 152. Cha J-Y, Kim H, Kim K-S, Hur M-W, Ahn Y. Identification of Transacting Factors Responsible for the Tissue-specific Expression of Human Glucose Transporter Type 2 Isoform Gene. *J Biol Chem* [Internet]. 2000 Jun 16;275(24):18358–65. Available from: <http://www.jbc.org/lookup/doi/10.1074/jbc.M909536199>
 153. Wang H, Maechler P, Hagenfeldt KA, Wolheim CB. Dominant-negative suppression of HNF-1alpha function results in defective insulin gene transcription and impaired metabolism-secretion coupling in a pancreatic beta -cell line. *EMBO J* [Internet]. 1998 Nov 16;17(22):6701–13. Available from: <http://www.pubmedcentral.nih.gov/articlerender.fcgi?artid=1171015&tool=pmcentrez&rendertype=abstract>
 154. Byrne MM, Sturis J, Menzel S, Yamagata K, Fajans SS, Dronsfield MJ, et al. Altered Insulin Secretory Responses to Glucose in Diabetic and Nondiabetic Subjects With Mutations in the Diabetes Susceptibility Gene MODY3 on Chromosome 12. *Diabetes* [Internet]. 1996 Nov 1;45(11):1503–10. Available from: <http://diabetes.diabetesjournals.org/cgi/doi/10.2337/diab.45.11.1503>
 155. Dukes ID, Sreenan S, Roe MW, Levisetti M, Zhou Y-P, Ostrega D, et al. Defective Pancreatic β -Cell Glycolytic Signaling in Hepatocyte Nuclear Factor-1 α -deficient Mice. *J Biol Chem* [Internet]. 1998 Sep 18;273(38):24457–64. Available from: <http://www.jbc.org/lookup/doi/10.1074/jbc.273.38.24457>
 156. Pontoglio M, Sreenan S, Roe M, Pugh W, Ostrega D, Doyen A, et al. Defective insulin secretion in hepatocyte nuclear factor 1alpha-deficient mice. *J Clin Invest* [Internet]. 1998 May 15;101(10):2215–22. Available from: <http://www.jci.org/articles/view/2548>
 157. Pontoglio M, Prié D, Cheret C, Doyen A, Leroy C, Froguel P, et al. HNF1 α controls renal glucose reabsorption in mouse and man. *EMBO Rep* [Internet]. 2000 Oct;1(4):359–65. Available from: <https://onlinelibrary.wiley.com/doi/abs/10.1093/embo-reports/kvd071>
 158. Hansen SK, Párrizas M, Jensen ML, Pruhova S, Ek J, Boj SF, et al. Genetic evidence that HNF-1 α -dependent transcriptional control of HNF-4 α is essential for human

- pancreatic β cell function. *J Clin Invest* [Internet]. 2002 Sep 15;110(6):827–33. Available from: <http://www.jci.org/articles/view/15085>
159. Stride A, Ellard S, Clark P, Shakespeare L, Salzman M, Shepherd M, et al. Beta-Cell Dysfunction, Insulin Sensitivity, and Glycosuria Precede Diabetes in Hepatocyte Nuclear Factor-1 Mutation Carriers. *Diabetes Care* [Internet]. 2005 Jul 1;28(7):1751–6. Available from: <http://care.diabetesjournals.org/cgi/doi/10.2337/diacare.28.7.1751>
 160. Valkovicova T, Skopkova M, Stanik J, Gasperikova D. Novel insights into genetics and clinics of the HNF1A-MODY. *Endocr Regul* [Internet]. 2019 Apr 1;53(2):110–34. Available from: <https://content.sciendo.com/doi/10.2478/enr-2019-0013>
 161. Stride A, Vaxillaire M, Tuomi T, Barbetti F, Njølstad PR, Hansen T, et al. The genetic abnormality in the beta cell determines the response to an oral glucose load. *Diabetologia* [Internet]. 2002 Mar 5;45(3):427–35. Available from: <http://link.springer.com/10.1007/s00125-001-0770-9>
 162. Steele AM, Shields BM, Shepherd M, Ellard S, Hattersley AT, Pearson ER. Increased all-cause and cardiovascular mortality in monogenic diabetes as a result of mutations in the HNF1A gene. *Diabet Med* [Internet]. 2010 Feb;27(2):157–61. Available from: <http://doi.wiley.com/10.1111/j.1464-5491.2009.02913.x>
 163. Velho G, Vaxillaire M, Boccio V, Charpentier G, Froguel P. Diabetes Complications in NIDDM Kindreds Linked to the MODY3 Locus on Chromosome 12q. *Diabetes Care* [Internet]. 1996 Sep 1;19(9):915–9. Available from: <http://care.diabetesjournals.org/cgi/doi/10.2337/diacare.19.9.915>
 164. Owen KR, Thanabalasingham G, James TJ, Karpe F, Farmer AJ, McCarthy MI, et al. Assessment of High-Sensitivity C-Reactive Protein Levels as Diagnostic Discriminator of Maturity-Onset Diabetes of the Young Due to HNF1A Mutations. *Diabetes Care* [Internet]. 2010 Sep 1;33(9):1919–24. Available from: <http://care.diabetesjournals.org/cgi/doi/10.2337/dc10-0288>
 165. Pearson ER, Liddell WG, Shepherd M, Corral RJ, Hattersley AT. Sensitivity to sulphonylureas in patients with hepatocyte nuclear factor-1alpha gene mutations: evidence for pharmacogenetics in diabetes. *Diabet Med* [Internet]. 2000 Jul;17(7):543–5. Available from: <http://doi.wiley.com/10.1046/j.1464-5491.2000.00305.x>
 166. Shepherd M, Shields B, Ellard S, Rubio-Cabezas O, Hattersley AT. A genetic diagnosis of HNF1A diabetes alters treatment and improves glycaemic control in the majority of insulin-treated patients. *Diabet Med* [Internet]. 2009 Apr;26(4):437–41. Available from: <http://doi.wiley.com/10.1111/j.1464-5491.2009.02690.x>
 167. Babenko AP, Polak M, Cavé H, Busiah K, Czernichow P, Scharfmann R, et al. Activating Mutations in the ABCC8 Gene in Neonatal Diabetes Mellitus. *N Engl J Med* [Internet]. 2006 Aug 3;355(5):456–66. Available from: <https://linkinghub.elsevier.com/retrieve/pii/S0925838818310491>
 168. Santana LS, Caetano LA, Costa-Riquetto AD, Franco PC, Dotto RP, Reis AF, et al. Targeted sequencing identifies novel variants in common and rare MODY genes. *Mol Genet Genomic Med* [Internet]. 2019 Dec 8;7(12):1–17. Available from: <https://onlinelibrary.wiley.com/doi/abs/10.1002/mgg3.962>
 169. Benoit G, Cooney A, Giguere V, Ingraham H, Lazar M, Muscat G, et al. International Union of Pharmacology. LXVI. Orphan Nuclear Receptors. *Pharmacol Rev* [Internet]. 2006 Dec;58(4):798–836. Available from: <http://pharmrev.aspetjournals.org/lookup/doi/10.1124/pr.58.4.10>

170. Ko HL, Zhuo Z, Ren EC. HNF4 α Combinatorial Isoform Heterodimers Activate Distinct Gene Targets that Differ from Their Corresponding Homodimers. *Cell Rep* [Internet]. 2019 Mar;26(10):2549-2557.e3. Available from: <https://doi.org/10.1016/j.celrep.2019.02.033>
171. Chandra V, Huang P, Potluri N, Wu D, Kim Y, Rastinejad F. Multidomain integration in the structure of the HNF-4 α nuclear receptor complex. *Nature* [Internet]. 2013 Mar 13;495(7441):394–8. Available from: <http://dx.doi.org/10.1038/nature11966>
172. Dhe-Paganon S, Duda K, Iwamoto M, Chi Y-I, Shoelson SE. Crystal Structure of the HNF4 α Ligand Binding Domain in Complex with Endogenous Fatty Acid Ligand. *J Biol Chem* [Internet]. 2002 Oct 11;277(41):37973–6. Available from: <http://www.jbc.org/lookup/doi/10.1074/jbc.C200420200>
173. Thomas H, Jaschkowitz K, Bulman M, Frayling TM, Mitchell SM, Roosen S, et al. A distant upstream promoter of the HNF-4 α gene connects the transcription factors involved in maturity-onset diabetes of the young. *Hum Mol Genet* [Internet]. 2001 Sep 1;10(19):2089–97. Available from: <https://academic.oup.com/hmg/article-lookup/doi/10.1093/hmg/10.19.2089>
174. Furuta H, Iwasaki N, Oda N, Hinokio Y, Horikawa Y, Yamagata K, et al. Organization and Partial Sequence of the Hepatocyte Nuclear Factor-4 /MODY1 Gene and Identification of a Missense Mutation, R127W, in a Japanese Family With MODY. *Diabetes* [Internet]. 1997 Oct 1;46(10):1652–7. Available from: <http://diabetes.diabetesjournals.org/cgi/doi/10.2337/diacare.46.10.1652>
175. Nakhei H, Lingott A, Lemm I, Ryffel GU. An alternative splice variant of the tissue specific transcription factor HNF4 predominates in undifferentiated murine cell types. *Nucleic Acids Res* [Internet]. 1998 Jan 1;26(2):497–504. Available from: <https://academic.oup.com/nar/article-lookup/doi/10.1093/nar/26.2.497>
176. Lambert É, Babeu J-P, Simoneau J, Raisch J, Lavergne L, Lévesque D, et al. Human Hepatocyte Nuclear Factor 4- α Encodes Isoforms with Distinct Transcriptional Functions. *Mol Cell Proteomics* [Internet]. 2020 May;19(5):808–27. Available from: <http://www.mcponline.org/lookup/doi/10.1074/mcp.RA119.001909>
177. Babeu J-P, Boudreau F. Hepatocyte nuclear factor 4- α involvement in liver and intestinal inflammatory networks. *World J Gastroenterol* [Internet]. 2014;20(1):22–30. Available from: <http://www.wjgnet.com/1007-9327/full/v20/i1/22.htm>
178. Stoffel M, Duncan SA. The maturity-onset diabetes of the young (MODY1) transcription factor HNF4 regulates expression of genes required for glucose transport and metabolism. *Proc Natl Acad Sci* [Internet]. 1997 Nov 25;94(24):13209–14. Available from: <http://www.ncbi.nlm.nih.gov/pubmed/9371825> <http://www.pubmedcentral.nih.gov/articlerender.fcgi?artid=PMC24288>
179. Lehto M, Bitzen PO, Isomaa B, Wipemo C, Wessman Y, Forsblom C, et al. Mutation in the HNF-4 α gene affects insulin secretion and triglyceride metabolism. *Diabetes* [Internet]. 1999 Feb 1;48(2):423–5. Available from: <http://diabetes.diabetesjournals.org/content/47/3/487.full.pdf#page=1&view=FitH>
180. Pearson ER, Pruhova S, Tack CJ, Johansen A, Castleden HAJ, Lumb PJ, et al. Molecular genetics and phenotypic characteristics of MODY caused by hepatocyte nuclear factor 4 α mutations in a large European collection. *Diabetologia* [Internet]. 2005 May 14;48(5):878–85. Available from: <http://link.springer.com/10.1007/s00125->

181. Pearson ER, Boj SF, Steele AM, Barrett T, Stals K, Shield JP, et al. Macrosomia and Hyperinsulinaemic Hypoglycaemia in Patients with Heterozygous Mutations in the HNF4A Gene. Groop LC, editor. PLoS Med [Internet]. 2007 Apr 3;4(4):e118. Available from: <https://dx.plos.org/10.1371/journal.pmed.0040118>
182. Delvecchio M, Pastore C, Giordano P. Treatment Options for MODY Patients: A Systematic Review of Literature. Diabetes Ther [Internet]. 2020 Jun 24; Available from: <https://doi.org/10.1007/s13300-020-00864-4>
183. Kapoor RR, Locke J, Colclough K, Wales J, Conn JJ, Hattersley AT, et al. Persistent Hyperinsulinemic Hypoglycemia and Maturity-Onset Diabetes of the Young Due to Heterozygous HNF4A Mutations. Diabetes [Internet]. 2008 Jun 1;57(6):1659–63. Available from: <http://diabetes.diabetesjournals.org/cgi/doi/10.2337/db07-1657>
184. Flanagan SE, Kapoor RR, Mali G, Cody D, Murphy N, Schwahn B, et al. Diazoxide-responsive hyperinsulinemic hypoglycemia caused by HNF4A gene mutations. Eur J Endocrinol [Internet]. 2010 May;162(5):987–92. Available from: <https://ej.e.bioscientifica.com/view/journals/eje/162/5/987.xml>
185. Beards F, Frayling T, Bulman M, Horikawa Y, Allen L, Appleton M, et al. Mutations in hepatocyte nuclear factor 1beta are not a common cause of maturity-onset diabetes of the young in the U.K. Diabetes [Internet]. 1998 Jul 1;47(7):1152–4. Available from: <http://diabetes.diabetesjournals.org/content/47/3/487.full.pdf#page=1&view=FitH>
186. Chen YZ, Gao Q, Zhao XZ, Chen YZ, Bennett CL, Xiong XS, et al. Systematic review of TCF2 anomalies in renal cysts and diabetes syndrome/maturity onset diabetes of the young type 5. Chin Med J (Engl) [Internet]. 2010;123(22):3326–33. Available from: <https://europepmc.org/article/med/21163139>
187. Komazec J, Zdravkovic V, Sajic S, Jesic M, Andjelkovic M, Pavlovic S, et al. The importance of combined NGS and MLPA genetic tests for differential diagnosis of maturity onset diabetes of the young. Endokrynol Pol [Internet]. 2019 Feb 22;70(1):28–36. Available from: <http://www.ncbi.nlm.nih.gov/pubmed/24002961>
188. Bellanne-Chantelot C, Clauin S, Chauveau D, Collin P, Daumont M, Douillard C, et al. Large Genomic Rearrangements in the Hepatocyte Nuclear Factor-1 (TCF2) Gene Are the Most Frequent Cause of Maturity-Onset Diabetes of the Young Type 5. Diabetes [Internet]. 2005 Nov 1;54(11):3126–32. Available from: <http://diabetes.diabetesjournals.org/cgi/doi/10.2337/diabetes.54.11.3126>
189. Carette C, Vaury C, Barthélémy A, Clauin S, Grünfeld J-P, Timsit J, et al. Exonic Duplication of the Hepatocyte Nuclear Factor-1 β Gene (Transcription Factor 2, Hepatic) as a Cause of Maturity Onset Diabetes of the Young Type 5. J Clin Endocrinol Metab [Internet]. 2007 Jul 1;92(7):2844–7. Available from: <https://academic.oup.com/jcem/article/92/7/2844/2599016>
190. Dotto RP, Santana LS de, Lindsey SC, Caetano LA, Franco LF, Moisés RCMS, et al. Searching for mutations in the HNF1B gene in a Brazilian cohort with renal cysts and hyperglycemia. Arch Endocrinol Metab [Internet]. 2019 Apr 26;63(3):250–7. Available from: http://www.scielo.br/scielo.php?script=sci_arttext&pid=S2359-39972019005003107&lng=en&nrm=iso
191. Mefford HC, Clauin S, Sharp AJ, Moller RS, Ullmann R, Kapur R, et al. Recurrent Reciprocal Genomic Rearrangements of 17q12 Are Associated with Renal Disease, Diabetes, and Epilepsy. Am J Hum Genet [Internet]. 2007 Nov;81(5):1057–69.

Available from: <https://linkinghub.elsevier.com/retrieve/pii/S0002929707638804>

192. Ulinski T, Lescure S, Beaufile S, Guignon V, Decramer S, Morin D, et al. Renal Phenotypes Related to Hepatocyte Nuclear Factor-1 β (TCF2) Mutations in a Pediatric Cohort. *J Am Soc Nephrol* [Internet]. 2006 Jan;17(2):497–503. Available from: <http://www.jasn.org/lookup/doi/10.1681/ASN.2005101040>
193. Edghill EL, Bingham C, Ellard S, Hattersley AT. Mutations in hepatocyte nuclear factor-1 and their related phenotypes. *J Med Genet* [Internet]. 2006 May 27;43(1):84–90. Available from: <http://jmg.bmj.com/cgi/doi/10.1136/jmg.2005.032854>
194. Clissold RL, Hamilton AJ, Hattersley AT, Ellard S, Bingham C. HNF1B-associated renal and extra-renal disease—an expanding clinical spectrum. *Nat Rev Nephrol* [Internet]. 2015 Feb 23;11(2):102–12. Available from: <http://dx.doi.org/10.1038/nrneph.2014.232>
195. Tomura H, Nishigori H, Sho K, Yamagata K, Inoue I, Takeda J. Loss-of-function and Dominant-negative Mechanisms Associated with Hepatocyte Nuclear Factor-1 β Mutations in Familial Type 2 Diabetes Mellitus. *J Biol Chem* [Internet]. 1999 May 7;274(19):12975–8. Available from: <http://www.jbc.org/lookup/doi/10.1074/jbc.274.19.12975>
196. Verhave JC, Bech AP, Wetzels JFM, Nijenhuis T. Hepatocyte Nuclear Factor 1 β – Associated Kidney Disease: More than Renal Cysts and Diabetes. *J Am Soc Nephrol* [Internet]. 2016 Feb;27(2):345–53. Available from: <http://www.jasn.org/lookup/doi/10.1681/ASN.2015050544>
197. Barbacci E, Reber M, Ott MO, Breillat C, Huetz F, Cereghini S. Variant Hepatocyte Nuclear Factor 1 is required for visceral endoderm specification. *Development* [Internet]. 1999;126(21):4795–805. Available from: <https://dev.biologists.org/content/126/21/4795.long>
198. Bingham C, Hattersley AT. Renal cysts and diabetes syndrome resulting from mutations in hepatocyte nuclear factor-1. *Nephrol Dial Transplant* [Internet]. 2004 Sep 22;19(11):2703–8. Available from: <https://academic.oup.com/ndt/article-lookup/doi/10.1093/ndt/gfh348>
199. Adalat S, Woolf AS, Johnstone KA, Wirsing A, Harries LW, Long DA, et al. HNF1B Mutations Associate with Hypomagnesemia and Renal Magnesium Wasting. *J Am Soc Nephrol* [Internet]. 2009 May;20(5):1123–31. Available from: <http://www.jasn.org/lookup/doi/10.1681/ASN.2008060633>
200. Bingham C, Ellard S, van't Hoff WG, Simmonds HA, Marinaki AM, Badman MK, et al. Atypical familial juvenile hyperuricemic nephropathy associated with a hepatocyte nuclear factor-1 β gene mutation. *Kidney Int* [Internet]. 2003 May;63(5):1645–51. Available from: <https://linkinghub.elsevier.com/retrieve/pii/S0085253815490532>
201. Bingham C, Ellard S, Cole TRP, Jones KE, Allen LIS, Goodship JA, et al. Solitary functioning kidney and diverse genital tract malformations associated with hepatocyte nuclear factor-1 β mutations. *Kidney Int* [Internet]. 2002 Apr;61(4):1243–51. Available from: <https://linkinghub.elsevier.com/retrieve/pii/S0085253815483450>
202. Bingham C, Ellard S, Allen L, Bulman M, Shepherd M, Frayling T, et al. Abnormal nephron development associated with a frameshift mutation in the transcription factor hepatocyte nuclear factor-1 β 1. *Kidney Int* [Internet]. 2000 Mar;57(3):898–907. Available from: <https://linkinghub.elsevier.com/retrieve/pii/S008525381546822X>

203. Lindner T, Njølstad PR, Horikawa Y, Bostad L, Bell GI, Sovik O. A novel syndrome of diabetes mellitus, renal dysfunction and genital malformation associated with a partial deletion of the pseudo-POU domain of hepatocyte nuclear factor-1beta. *Hum Mol Genet* [Internet]. 1999 Oct 1;8(11):2001–8. Available from: <https://academic.oup.com/hmg/article-lookup/doi/10.1093/hmg/8.11.2001>
204. Yorifuji T, Kurokawa K, Mamada M, Imai T, Kawai M, Nishi Y, et al. Neonatal Diabetes Mellitus and Neonatal Polycystic, Dysplastic Kidneys: Phenotypically Discordant Recurrence of a Mutation in the Hepatocyte Nuclear Factor-1 β Gene Due to Germline Mosaicism. *J Clin Endocrinol Metab* [Internet]. 2004 Jun;89(6):2905–8. Available from: <https://academic.oup.com/jcem/article-lookup/doi/10.1210/jc.2003-031828>
205. Brackenridge A, Pearson ER, Shojaee-Moradie F, Hattersley AT, Russell-Jones D, Umpleby AM. Contrasting Insulin Sensitivity of Endogenous Glucose Production Rate in Subjects With Hepatocyte Nuclear Factor-1 and -1 Mutations. *Diabetes* [Internet]. 2006 Feb 1;55(2):405–11. Available from: <http://diabetes.diabetesjournals.org/cgi/doi/10.2337/diabetes.55.02.06.db05-1019>
206. Pearson ER, Badman MK, Lockwood CR, Clark PM, Ellard S, Bingham C, et al. Contrasting Diabetes Phenotypes Associated With Hepatocyte Nuclear Factor-1 and -1 Mutations. *Diabetes Care* [Internet]. 2004 May 1;27(5):1102–7. Available from: <http://care.diabetesjournals.org/cgi/doi/10.2337/diacare.27.5.1102>
207. Loirat C, Bellanné-Chantelot C, Husson I, Deschênes G, Guignonis V, Chabane N. Autism in three patients with cystic or hyperechogenic kidneys and chromosome 17q12 deletion. *Nephrol Dial Transplant* [Internet]. 2010 Oct;25(10):3430–3. Available from: <https://academic.oup.com/ndt/article-lookup/doi/10.1093/ndt/gfq380>
208. Ferrè S, Bongers EMHF, Sonneveld R, Cornelissen EAM, van der Vlag J, van Boekel GAJ, et al. Early Development of Hyperparathyroidism Due to Loss of PTH Transcriptional Repression in Patients With HNF1 β Mutations? *J Clin Endocrinol Metab* [Internet]. 2013 Oct;98(10):4089–96. Available from: <https://academic.oup.com/jcem/article-lookup/doi/10.1210/jc.2012-3453>
209. Yan J, Jiang F, Zhang R, Xu T, Zhou Z, Ren W, et al. Whole-exome sequencing identifies a novel INS mutation causative of maturity-onset diabetes of the young 10. *J Mol Cell Biol* [Internet]. 2017 Oct 1;9(5):376–83. Available from: <https://academic.oup.com/jmcb/article/9/5/376/4092810>
210. Zhang J, Liu Y, Li M, Ge X, Wang Y, Huang X, et al. Identification of Ala2Thr mutation in insulin gene from a Chinese MODY10 family. *Mol Cell Biochem* [Internet]. 2020 Jul 13;470(1–2):77–86. Available from: <https://doi.org/10.1007/s11010-020-03748-0>
211. Bell GI, Pictet RL, Rutter WJ, Cordell B, Tischer E, Goodman HM. Sequence of the human insulin gene. *Nature* [Internet]. 1980 Mar;284(5751):26–32. Available from: <http://www.nature.com/articles/284026a0>
212. Dodson G, Steiner D. The role of assembly in insulin's biosynthesis. *Curr Opin Struct Biol* [Internet]. 1998 Apr;8(2):189–94. Available from: <https://linkinghub.elsevier.com/retrieve/pii/S0959440X98800377>
213. Ushijima K, Narumi S, Ogata T, Yokota I, Sugihara S, Kaname T, et al. KLF11 variant in a family clinically diagnosed with early childhood-onset type 1B diabetes. *Pediatr Diabetes* [Internet]. 2019 Jun 3;20(6):pedi.12868. Available from:

- <https://onlinelibrary.wiley.com/doi/abs/10.1111/pedi.12868>
214. Kaczynski J, Cook T, Urrutia R. Sp1- and Krüppel-like transcription factors. *Genome Biol* [Internet]. 2003;4(2):206. Available from: <http://www.ncbi.nlm.nih.gov/pubmed/12620113>
 215. Cook T, Gebelein B, Belal M, Mesa K, Urrutia R. Three Conserved Transcriptional Repressor Domains Are a Defining Feature of the TIEG Subfamily of Sp1-like Zinc Finger Proteins. *J Biol Chem* [Internet]. 1999 Oct 8;274(41):29500–4. Available from: <http://www.jbc.org/lookup/doi/10.1074/jbc.274.41.29500>
 216. Cook T, Gebelein B, Mesa K, Mladek A, Urrutia R. Molecular Cloning and Characterization of TIEG2 Reveals a New Subfamily of Transforming Growth Factor- β -inducible Sp1-like Zinc Finger-encoding Genes Involved in the Regulation of Cell Growth. *J Biol Chem* [Internet]. 1998 Oct 2;273(40):25929–36. Available from: <http://www.jbc.org/lookup/doi/10.1074/jbc.273.40.25929>
 217. Fernandez-Zapico ME, van Velkinburgh JC, Gutiérrez-Aguilar R, Neve B, Froguel P, Urrutia R, et al. MODY7 Gene, KLF11, Is a Novel p300-dependent Regulator of Pdx-1 (MODY4) Transcription in Pancreatic Islet β Cells. *J Biol Chem* [Internet]. 2009 Dec 25;284(52):36482–90. Available from: <http://www.jbc.org/lookup/doi/10.1074/jbc.M109.028852>
 218. D'Amato E, Tammaro P, Craig TJ, Tosi A, Giorgetti R, Lorini R, et al. Variable phenotypic spectrum of diabetes mellitus in a family carrying a novel KCNJ11 gene mutation. *Diabet Med* [Internet]. 2008 Jun;25(6):651–6. Available from: <http://doi.wiley.com/10.1111/j.1464-5491.2008.02443.x>
 219. Hattersley AT, Ashcroft FM. Activating Mutations in Kir6.2 and Neonatal Diabetes: New Clinical Syndromes, New Scientific Insights, and New Therapy. *Diabetes* [Internet]. 2005 Sep 1;54(9):2503–13. Available from: <http://diabetes.diabetesjournals.org/cgi/doi/10.2337/diabetes.54.9.2503>
 220. Flanagan SE, Patch A-M, Mackay DJG, Edghill EL, Gloyn AL, Robinson D, et al. Mutations in ATP-Sensitive K⁺ Channel Genes Cause Transient Neonatal Diabetes and Permanent Diabetes in Childhood or Adulthood. *Diabetes* [Internet]. 2007 Jul 1;56(7):1930–7. Available from: <http://diabetes.diabetesjournals.org/cgi/doi/10.2337/db07-0043>
 221. Hashimoto Y, Dateki S, Hirose M, Satomura K, Sawada H, Mizuno H, et al. Molecular and clinical features of K ATP -channel neonatal diabetes mellitus in Japan. *Pediatr Diabetes* [Internet]. 2017 Nov;18(7):532–9. Available from: <http://doi.wiley.com/10.1111/pedi.12447>
 222. Ashcroft FM, Puljung MC, Vedovato N. Neonatal Diabetes and the K ATP Channel: From Mutation to Therapy. *Trends Endocrinol Metab* [Internet]. 2017 May;28(5):377–87. Available from: <http://dx.doi.org/10.1016/j.tem.2017.02.003>
 223. Beltrand J, Elie C, Busiah K, Fournier E, Boddaert N, Bahi-Buisson N, et al. Sulfonylurea Therapy Benefits Neurological and Psychomotor Functions in Patients With Neonatal Diabetes Owing to Potassium Channel Mutations. *Diabetes Care* [Internet]. 2015 Nov;38(11):2033–41. Available from: <http://care.diabetesjournals.org/lookup/doi/10.2337/dc15-0837>
 224. Bowman P, Broadbridge E, Knight BA, Pettit L, Flanagan SE, Reville M, et al. Psychiatric morbidity in children with KCNJ11 neonatal diabetes. *Diabet Med* [Internet]. 2016 Oct;33(10):1387–91. Available from:

<http://doi.wiley.com/10.1111/dme.13135>

225. McTaggart JS, Jenkinson N, Brittain J-S, Greeley SAW, Hattersley AT, Ashcroft FM. Gain-of-Function Mutations in the KATP Channel (KCNJ11) Impair Coordinated Hand-Eye Tracking. Attali B, editor. *PLoS One* [Internet]. 2013 Apr 23;8(4):e62646. Available from: <https://dx.plos.org/10.1371/journal.pone.0062646>
226. Kristinsson SY, Talseth B, Steingrímsson E, Thorsson A V., Helgason T, Hreidarsson AB, et al. MODY in Iceland is associated with mutations in HNF -1alpha and a novel mutation in NeuroD1. *Diabetologia* [Internet]. 2001 Nov 1;44(11):2098–103. Available from: <http://link.springer.com/10.1007/s001250100016>
227. Gonsorčíková L, Průhová Š, Cinek O, Ek J, Pelikánová T, Jørgensen T, et al. Autosomal inheritance of diabetes in two families characterized by obesity and a novel H241Q mutation in NEUROD1. *Pediatr Diabetes* [Internet]. 2008 Aug;9(4pt2):367–72. Available from: <http://doi.wiley.com/10.1111/j.1399-5448.2008.00379.x>
228. Ağladioğlu SY, Aycan Z, Çetinkaya S, Baş VN, Önder A, Peltek Kendirci HN, et al. Maturity onset diabetes of youth (MODY) in Turkish children: sequence analysis of 11 causative genes by next generation sequencing. *J Pediatr Endocrinol Metab* [Internet]. 2016 Jan 1;29(4):487–96. Available from: <https://www.degruyter.com/view/j/jpem.2016.29.issue-4/jpem-2015-0039/jpem-2015-0039.xml>
229. Szopa M, Ludwig-Galezowska AH, Radkowski P, Skupien J, Machlowska J, Klupa T, et al. A family with the Arg103Pro mutation in the NEUROD1 gene detected by next-generation sequencing - Clinical characteristics of mutation carriers. *Eur J Med Genet* [Internet]. 2016;59(2):75–9. Available from: <http://dx.doi.org/10.1016/j.ejmg.2016.01.002>
230. Liu L, Furuta H, Minami A, Zheng T, Jia W, Nanjo K, et al. A novel mutation, Ser159Pro in the NeuroD1/BETA2 gene contributes to the development of diabetes in a Chinese potential MODY family. *Mol Cell Biochem* [Internet]. 2007 Aug 8;303(1–2):115–20. Available from: <http://link.springer.com/10.1007/s11010-007-9463-0>
231. Chapla A, Mruthyunjaya MD, Asha HS, Varghese D, Varshney M, Vasani SK, et al. Maturity onset diabetes of the young in India - a distinctive mutation pattern identified through targeted next-generation sequencing. *Clin Endocrinol (Oxf)* [Internet]. 2015 Apr;82(4):533–42. Available from: <http://doi.wiley.com/10.1111/cen.12541>
232. Ang SF, Lim SC, Tan CS, Fong JC, Kon WY, Lian JX, et al. A preliminary study to evaluate the strategy of combining clinical criteria and next generation sequencing (NGS) for the identification of monogenic diabetes among multi-ethnic Asians. *Diabetes Res Clin Pract* [Internet]. 2016 Sep;119:13–22. Available from: <http://dx.doi.org/10.1016/j.diabres.2016.06.008>
233. Horikawa Y, Enya M, Mabe H, Fukushima K, Takubo N, Ohashi M, et al. NEUROD1-deficient diabetes (MODY6): Identification of the first cases in Japanese and the clinical features. *Pediatr Diabetes* [Internet]. 2018 Mar 30;19(2):236–42. Available from: <https://onlinelibrary.wiley.com/doi/abs/10.1111/pedi.12553>
234. Doddabelavangala Mruthyunjaya M, Chapla A, Hesarghatta Shyamasunder A, Varghese D, Varshney M, Paul J, et al. Comprehensive Maturity Onset Diabetes of the Young (MODY) Gene Screening in Pregnant Women with Diabetes in India. El-Maarri O, editor. *PLoS One* [Internet]. 2017 Jan 17;12(1):e0168656. Available from: <https://dx.plos.org/10.1371/journal.pone.0168656>

235. Naya FJ, Stellrecht CMM, Tsai MJ. Tissue-specific regulation of the insulin gene by a novel basic helix-loop-helix transcription factor. *Genes Dev* [Internet]. 1995;9(8):1009–19. Available from: <http://genesdev.cshlp.org/content/9/8/1009.long>
236. Horikawa Y, Enya M. Genetic Dissection and Clinical Features of MODY6 (NEUROD1-MODY). *Curr Diab Rep* [Internet]. 2019 Mar 22;19(3):12. Available from: <http://link.springer.com/10.1007/s11892-019-1130-9>
237. Jo W, Endo M, Ishizu K, Nakamura A, Tajima T. A novel PAX4 mutation in a Japanese patient with Maturity-onset diabetes of the young. *Tohoku J Exp Med* [Internet]. 2011;223(2):113–8. Available from: <http://joi.jlc.jst.go.jp/JST.JSTAGE/tjem/223.113?from=CrossRef>
238. Sujitjoo J, Kooptiwut S, Chongjaroen N, Tangjittipokin W, Plengvidhya N, Yenchitsomanus P thai. Aberrant mRNA splicing of paired box 4 (PAX4) IVS7-1G>A mutation causing maturity-onset diabetes of the young, type 9. *Acta Diabetol*. 2016;53(2):205–16.
239. Greenwood AL, Li S, Jones K, Melton DA. Notch signaling reveals developmental plasticity of Pax4+ pancreatic endocrine progenitors and shunts them to a duct fate. *Mech Dev* [Internet]. 2007 Feb;124(2):97–107. Available from: <https://linkinghub.elsevier.com/retrieve/pii/S0925477306002024>
240. Lorenzo PI, Fuente-Martín E, Brun T, Cobo-Vuilleumier N, Jimenez-Moreno CM, G. Herrera Gomez I, et al. PAX4 Defines an Expandable β -Cell Subpopulation in the Adult Pancreatic Islet. *Sci Rep* [Internet]. 2015 Dec 27;5(1):15672. Available from: <http://www.nature.com/articles/srep15672>
241. Napolitano T, Avolio F, Courtney M, Vieira A, Druelle N, Ben-Othman N, et al. Pax4 acts as a key player in pancreas development and plasticity. *Semin Cell Dev Biol* [Internet]. 2015 Aug;44:107–14. Available from: <http://dx.doi.org/10.1016/j.semcdb.2015.08.013>
242. Hani EH, Stoffers DA, Chèvre J-C, Durand E, Stanojevic V, Dina C, et al. Defective mutations in the insulin promoter factor-1 (IPF-1) gene in late-onset type 2 diabetes mellitus. *J Clin Invest* [Internet]. 1999 Nov 1;104(9):R41–8. Available from: <http://www.jci.org/articles/view/7469>
243. Macfarlane WM, Frayling TM, Ellard S, Evans JC, Allen LIS, Bulman MP, et al. Missense mutations in the insulin promoter factor-1 gene predispose to type 2 diabetes. *J Clin Invest* [Internet]. 1999 Nov 1;104(9):R33–9. Available from: <http://www.jci.org/articles/view/7449>
244. Gragnoli C, Stanojevic V, Gorini A, Von Preussenthal GM, Thomas MK, Habener JF. IPF-1/MODY4 gene missense mutation in an Italian family with type 2 and gestational diabetes. *Metabolism* [Internet]. 2005 Aug;54(8):983–8. Available from: <https://linkinghub.elsevier.com/retrieve/pii/S0026049505000697>
245. Caetano LA, Santana LS, Costa-Riquetto AD, Lerario AM, Nery M, Nogueira GF, et al. PDX1 -MODY and dorsal pancreatic agenesis: New phenotype of a rare disease. *Clin Genet* [Internet]. 2018 Feb;93(2):382–6. Available from: <http://doi.wiley.com/10.1111/cge.13044>
246. Deng M, Xiao X, Zhou L, Wang T. First Case Report of Maturity-Onset Diabetes of the Young Type 4 Pedigree in a Chinese Family. *Front Endocrinol (Lausanne)* [Internet]. 2019 Jul 3;10(JULY):1–5. Available from: <https://www.frontiersin.org/article/10.3389/fendo.2019.00406/full>

247. Fajans SS, Bell GI, Paz VP, Below JE, Cox NJ, Martin C, et al. Obesity and hyperinsulinemia in a family with pancreatic agenesis and MODY caused by the IPF1 mutation Pro63fsX60. *Transl Res* [Internet]. 2010 Jul;156(1):7–14. Available from: <https://linkinghub.elsevier.com/retrieve/pii/S1931524410000745>
248. Schwitzgebel VM, Mamin A, Brun T, Ritz-Laser B, Zaiko M, Maret A, et al. Agenesis of Human Pancreas due to Decreased Half-Life of Insulin Promoter Factor 1. *J Clin Endocrinol Metab* [Internet]. 2003 Sep;88(9):4398–406. Available from: <https://academic.oup.com/jcem/article-lookup/doi/10.1210/jc.2003-030046>
249. Stoffers DA, Ferrer J, Clarke WL, Habener JF. Early-onset type-II diabetes mellitus (MODY4) linked to IPF1. *Nat Genet* [Internet]. 1997 Oct;17(2):138–9. Available from: <http://www.nature.com/articles/ng1097-138>
250. Anık A, Çatlı G, Abacı A, Sarı E, Yeşilkaya E, Korkmaz HA, et al. Molecular diagnosis of maturity-onset diabetes of the young (MODY) in Turkish children by using targeted next-generation sequencing. *J Pediatr Endocrinol Metab* [Internet]. 2015 Jan 1;28(11–12):1265–71. Available from: <https://www.degruyter.com/view/j/jpem.2015.28.issue-11-12/jpem-2014-0430/jpem-2014-0430.xml>
251. Waeber G, Thompson N, Nicod P, Bonny C. Transcriptional activation of the GLUT2 gene by the IPF-1/STF-1/IDX-1 homeobox factor. *Mol Endocrinol* [Internet]. 1996 Nov 1;10(11):1327–34. Available from: <http://press.endocrine.org/doi/10.1210/mend.10.11.8923459>
252. Watada H, Kajimoto Y, Kaneto H, Matsuoka T, Fujitani Y, Miyazaki J, et al. Involvement of the Homeodomain-Containing Transcription Factor PDX-1 in Islet Amyloid Polypeptide Gene Transcription. *Biochem Biophys Res Commun* [Internet]. 1996 Dec;229(3):746–51. Available from: <https://linkinghub.elsevier.com/retrieve/pii/S0006291X96918756>
253. Watada H, Kajimoto Y, Umayahara Y, Matsuoka T -a., Kaneto H, Fujitani Y, et al. The Human Glucokinase Gene -Cell-Type Promoter: An Essential Role of Insulin Promoter Factor 1/PDX-1 in Its Activation in HIT-T15 Cells. *Diabetes* [Internet]. 1996 Nov 1;45(11):1478–88. Available from: <http://diabetes.diabetesjournals.org/cgi/doi/10.2337/diab.45.11.1478>
254. Ohlsson H, Karlsson K, Edlund T. IPF1, a homeodomain-containing transactivator of the insulin gene. *EMBO J* [Internet]. 1993;12(11):4251–9. Available from: <https://europepmc.org/article/med/7901001>
255. Marshak S, Benschushan E, Shoshkes M, Havin L, Cerasi E, Melloul D. Functional Conservation of Regulatory Elements in the pdx-1 Gene: PDX-1 and Hepatocyte Nuclear Factor 3beta Transcription Factors Mediate beta -Cell-Specific Expression. *Mol Cell Biol* [Internet]. 2000;20(20):7583–90. Available from: <https://mcb.asm.org/content/20/20/7583>
256. Shepherd M, Shields B, Hammersley S, Hudson M, McDonald TJ, Colclough K, et al. Systematic Population Screening, Using Biomarkers and Genetic Testing, Identifies 2.5% of the U.K. Pediatric Diabetes Population With Monogenic Diabetes. *Diabetes Care* [Internet]. 2016 Nov;39(11):1879–88. Available from: <http://care.diabetesjournals.org/lookup/doi/10.2337/dc16-0645>
257. Abreu GDM, Tarantino RM, da Fonseca ACP, de Souza RB, Soares CAPD, Cabello PH, et al. PDX1-MODY: A rare missense mutation as a cause of monogenic diabetes.

- Eur J Med Genet [Internet]. 2021 May;64(5):104194. Available from: <https://linkinghub.elsevier.com/retrieve/pii/S1769721221000604>
258. Pearson ER, Starkey BJ, Powell RJ, Gribble FM, Clark PM, Hattersley AT. Genetic cause of hyperglycaemia and response to treatment in diabetes. *Lancet* [Internet]. 2003 Oct;362(9392):1275–81. Available from: <https://linkinghub.elsevier.com/retrieve/pii/S0140673603145710>
 259. de Medeiros Abreu G, de Almeida Pereira Dias Soares C, Magalhães Tarantino R, Proença da Fonseca AC, Bastos de Souza R, Carvalho Pereira M de F, et al. Identification of the First PAX4-MODY Family Reported in Brazil. *Diabetes, Metab Syndr Obes Targets Ther* [Internet]. 2020 Jul;13:2623–31. Available from: <https://www.dovepress.com/identification-of-the-first-pax4-mody-family-reported-in-brazil-peer-reviewed-article-DMSO>
 260. Chèvre J-C, Hani EH, Boutin P, Vaxillaire M, Blanché H, Vionnet N, et al. Mutation screening in 18 Caucasian families suggest the existence of other MODY genes. *Diabetologia* [Internet]. 1998 Aug 19;41(9):1017–23. Available from: <http://link.springer.com/10.1007/s001250051025>
 261. Estalella I, Rica I, De Nanclares GP, Bilbao JR, Vazquez JA, San Pedro JI, et al. Mutations in GCK and HNF-1 α explain the majority of cases with clinical diagnosis of MODY in Spain. *Clin Endocrinol (Oxf)* [Internet]. 2007;67(4):538–46. Available from: <https://onlinelibrary.wiley.com/doi/abs/10.1111/j.1365-2265.2007.02921.x>
 262. Boutin P, Chevre JC, Hani EH, Gomis R, Pardini VC, Guillausseau P-J, et al. An Automated Fluorescent Single-Strand Conformation Polymorphism Technique for Factor-1a Gene (Maturity-Onset Diabetes of the Young). *Diabetes* [Internet]. 1997;46(17):2108–9. Available from: <https://diabetes.diabetesjournals.org/content/46/12/2108.long>
 263. Maraschin J de F, Kannengiesser C, Murussi N, Campagnolo N, Canani LH, Gross JL, et al. HNF1 α Mutations Are Present in Half of Clinically Defined MODY Patients in South-Brazilian Individuals. *Arq Bras Endocrinol Metabol* [Internet]. 2008;52:1326–31. Available from: https://www.scielo.br/scielo.php?script=sci_arttext&pid=S0004-27302008000800020
 264. Bernier FP, Boneh A, Dennett X, Chow CW, Cleary MA, Thorburn DR. Diagnostic criteria for respiratory chain disorders in adults and children. *Neurology* [Internet]. 2002;59:1406–11. Available from: <https://n.neurology.org/content/59/9/1406>
 265. Hirano M, Ricci E, Koenigsberger R, Defendini R, Pavlakis SG, DeVivo DC, et al. MELAS : An original case and clinical criteria for diagnosis. *Neuromuscul Disord* [Internet]. 1992;2(2):125–35. Available from: <https://europepmc.org/article/med/1422200>
 266. Mancuso M, Orsucci D, Angelini C, Bertini E, Carelli V, Comi G Pietro, et al. The m.3243A>G mitochondrial DNA mutation and related phenotypes. A matter of gender? *J Neurol* [Internet]. 2014 Mar 29;261(3):504–10. Available from: <http://link.springer.com/10.1007/s00415-013-7225-3>
 267. Mcfarland R, Chinnery MRCP, Blakely EL, Schaefer AM, Morris AAM, Foster S, et al. Homoplasmy, heteroplasmy, and mitochondrial dystonia. *Neurology* [Internet]. 2007;69:911–7. Available from: <https://n.neurology.org/content/69/9/911>
 268. Chinnery P, Howell N, Lightowlers RN, Turnbull DM. Molecular pathology of MELAS and MERRF. The relationship between mutation load and clinical phenotypes.

- Brain a J Neurol [Internet]. 1997;120:1713–21. Available from: <https://academic.oup.com/brain/article/120/10/1713/262944>
269. Tarantino RM, Abreu G de M, Fonseca ACP de, Kupfer R, Pereira M de FC, Campos M, et al. MODY probability calculator for GCK and HNF1A screening in a multiethnic background population. Arch Endocrinol Metab [Internet]. 2019 Sep 25;1(8):1–7. Available from: http://www.scielo.br/scielo.php?script=sci_arttext&pid=S2359-39972019005008101&lng=en&nrm=iso
 270. Tatsi EB, Kanaka-Gantenbein C, Scorilas A, Chrousos GP, Sertedaki A. Next generation sequencing targeted gene panel in Greek MODY patients increases diagnostic accuracy. Pediatr Diabetes [Internet]. 2020 Feb 10;21(1):28–39. Available from: <https://onlinelibrary.wiley.com/doi/abs/10.1111/pedi.12931>
 271. Ellard S, Lango Allen H, De Franco E, Flanagan SE, Hysenaj G, Colclough K, et al. Improved genetic testing for monogenic diabetes using targeted next-generation sequencing. Diabetologia [Internet]. 2013 Sep 15;56(9):1958–63. Available from: <http://link.springer.com/10.1007/s00125-013-2962-5>
 272. Shields BM, McDonald TJ, Ellard S, Campbell MJ, Hyde C, Hattersley AT. The development and validation of a clinical prediction model to determine the probability of MODY in patients with young-onset diabetes. Diabetologia [Internet]. 2012 May 5;55(5):1265–72. Available from: <http://link.springer.com/10.1007/s00125-011-2418-8>
 273. SBD. Classificação e diagnóstico do diabetes mellitus. In: Clannad, editor. Diretrizes da Sociedade Brasileira de Diabetes. 2020. p. 19–26.
 274. SBD. Diabetes mellitus tipo 2 em jovens. In: Clannad, editor. Diretrizes da Sociedade Brasileira de Diabetes. 2020. p. 66–73.
 275. SBD. Avaliação e tratamento da paciente gestante com diabetes mellitus. In: Clannad, editor. Diretrizes da Sociedade Brasileira de Diabetes. 2020. p. 278–88.

7. Anexos

7.1 Anexo A. Termo de consentimento livre e esclarecido do HUCFF

UNIVERSIDADE FEDERAL DO RIO DE JANEIRO

HOSPITAL UNIVERSITÁRIO CLEMENTINO FRAGA FILHO
Serviço de Clínica Médica/ Nutrologia

Versão 2.0

Diagnóstico Molecular em pacientes jovens com diabetes mellitus e história familiar positiva

TERMO DE CONSENTIMENTO LIVRE E ESCLARECIDO (TCLE):

Você está sendo convidado a participar do projeto de pesquisa chamado **Diagnóstico Molecular em pacientes jovens com diabetes mellitus e história familiar positiva**. Essas informações estão sendo fornecidas para a sua participação voluntária neste estudo no Hospital Universitário Clementino Fraga Filho, que visa fazer o diagnóstico da alteração que pode causar o seu tipo de diabetes. O Diabetes Mellitus (DM) que está sendo estudado se caracteriza pelo início precoce, diagnosticado geralmente antes dos 25 anos em pelo menos um, e idealmente dois membros de uma mesma família. Outra característica é não necessitar de Insulina nos primeiros anos. Pela forma de herança deve haver DM em pelo menos duas e idealmente três gerações da mesma família. É causado por único defeito que altera a função da célula responsável pela produção de insulina pelo organismo. A frequência estimada é de que 1-2% de todos os casos de DM no mundo sejam desse tipo de DM. Entretanto, no Brasil a real frequência é desconhecida. A grande importância na detecção dos casos não é só para saber o real número de pessoas com a doença, mas para mudar o seu tratamento e poder detectar precocemente os parentes afetados.

- Você será submetido a coleta de sangue para a pesquisa da alteração genética que pode justificar o porquê do acometimento familiar tão importante de diabetes. Serão colhidos 3 a 4 mL em uma veia do braço com material esterilizado e descartável. Durante a coleta de sangue, você poderá sentir uma pequena dor no local. Poderá ocorrer como complicação do exame de sangue a formação de uma mancha temporária no local da retirada do sangue (hematoma). É recomendado apertar o local após coleta e não carregar peso no braço em que foi colhido o sangue.
- Durante a pesquisa, seu sangue ficará armazenado na geladeira do Laboratório de Endocrinologia Molecular, no Centro de Ciências da Saúde (CCS), sob a responsabilidade da professora Tânia Maria Ortega Carvalho. Todo material genético que não for utilizado após o término das análises, será descartado.
- Toda e qualquer estudo do seu sangue diferente da proposta neste projeto só ocorrerá mediante o seu consentimento.
- Você responderá a um questionário a respeito de fatores associados ao diabetes. Caso não se sinta confortável, poderá se recusar a responder as perguntas.
- Você poderá se retirar da pesquisa a qualquer momento, se assim desejar, permanecendo com o direito ao acompanhamento médico no Hospital Universitário.
- Sua identidade será preservada, e os resultados obtidos ao final do estudo serão publicados em revistas médicas.

1

- Os resultados de exames e a avaliação do seu prontuário serão utilizados somente pelos pesquisadores envolvidos nesse projeto e de outros profissionais que possam vir a ter algum relacionamento de atendimento ou de cuidados com você. Nunca haverá qualquer tipo de discriminação contra você.
- Você não terá despesas em qualquer fase do estudo, nem com os exames. Também não haverá nenhum tipo de pagamento pela sua participação.
- Você terá direito a todos os resultados dos exames realizados durante a pesquisa, que serão fornecidos pelo pesquisador responsável (Dra. Roberta Magalhães Tarantino Mamede) ao final da pesquisa.
- Você tem o direito de esclarecer dúvidas com o pesquisador, e ser examinado antes e durante a realização do trabalho, e sempre que se fizer necessário.
- Você tem a garantia de que o Hospital Universitário manterá o atendimento médico conforme realizado anteriormente ao início do trabalho.
- Você não terá nenhum custo em participar da pesquisa. As despesas com transporte extra (fora dos dias da consulta) ou alimentação (se for necessária) serão pagas pelo pesquisador.
- Em caso de dúvidas durante o período da pesquisa, você poderá entrar em contato com a pesquisadora Roberta Tarantino (tel: 2562-2730 ou 9966-9635). Se você tiver alguma consideração ou dúvida sobre a ética da pesquisa, entre em contato com o Comitê de Ética em Pesquisa (CEP) do Hospital Universitário Clementino Fraga Filho/HUCFF/UFRJ - R. Rodolpho Paulo Rocco, nº 255 - Cidade Universitária/Ilha do Fundão - sala D1D-46/1º andar - pelo telefone 2562-2480, de segunda a sexta-feira, das 8 às 15 horas, ou através do e-mail: cep@hucff.ufrj.br.

CONSENTIMENTO

Acredito ter sido suficientemente informado a respeito das informações sobre o estudo acima citado que li ou que foram lidas para mim.

Eu discuti com a Dra. Roberta Tarantino, sobre a minha decisão em participar nesse estudo. Ficou claro para mim quais são os propósitos do estudo, os procedimentos a serem realizados, seus desconfortos e riscos, as garantias de confidencialidade e de esclarecimentos permanentes. Ficou claro também que minha participação é isenta de despesas e que tenho garantia de acesso a tratamento hospitalar quando necessário. Concordo voluntariamente em participar desse estudo e poderei retirar o meu consentimento a qualquer momento, sem penalidades ou prejuízos e sem a perda de atendimento nesta Instituição ou de qualquer benefício que eu possa ter adquirido. Além disso, estou ciente de que eu (ou meu representante legal) e o pesquisador responsável por essa pesquisa deveremos rubricar todas as folhas desse Termo de Consentimento Livre e Esclarecido - TCLE, assinar a última página e que eu receberei uma via do TCLE assinada.

HUCFF, Rio de Janeiro, ____ / ____ / _____.

Nome do paciente

Assinatura do paciente

Assinatura do pesquisador

7.2 Anexo B. Termo de consentimento livre e esclarecido do IEDE



ESTADO DO RIO DE JANEIRO
SECRETARIA DE ESTADO DE SAÚDE
INSTITUTO ESTADUAL DE DIABETES E ENDOCRINOLOGIA LUIZ CAPRIGLIONE

Análise da mutação nos genes da glicoquinase (MODY 2) e HNF-1 α (MODY3) em pacientes jovens com diabetes mellitus e história familiar positiva

TERMO DE CONSENTIMENTO LIVRE E ESCLARECIDO (TCLE):

Você está sendo convidado a participar do projeto de pesquisa chamado **Diagnóstico Molecular em pacientes jovens com diabetes mellitus e história familiar positiva**. Essas informações estão sendo fornecidas para a sua participação voluntária neste estudo no Instituto Estadual de Diabetes e Endocrinologia Luiz Capriglione (IEDE), que visa fazer o diagnóstico da alteração que pode causar o seu tipo de diabetes. O Diabetes Mellitus (DM) que está sendo estudado se caracteriza pelo início precoce, diagnosticado geralmente antes dos 25 anos em pelo menos um, e idealmente dois membros de uma mesma família. Outra característica é não necessitar de insulina nos primeiros anos. Pela forma de herança deve haver DM em pelo menos duas e idealmente três gerações da mesma família. É causado por único defeito que altera a função da célula responsável pela produção de insulina pelo organismo. A frequência estimada é de que 1-2% de todos os casos de DM no mundo sejam desse tipo de DM. Entretanto, no Brasil a real frequência é desconhecida. A grande importância na detecção dos casos não é só para saber o real número de pessoas com a doença, mas para mudar o seu tratamento e poder detectar precocemente os parentes afetados.

- Você será submetido à coleta de sangue para a pesquisa da alteração genética que pode justificar o porquê do acometimento familiar tão importante de diabetes. Serão colhidos 3 a 4 mL em uma veia do braço com material esterilizado e descartável. Durante a coleta de sangue, você poderá sentir uma pequena dor no local. Poderá ocorrer como complicação do exame de sangue a formação de uma mancha temporária no local da retirada do sangue (hematoma). É recomendado apertar o local após coleta e não carregar peso no braço em que foi colhido o sangue. Durante a pesquisa, seu sangue ficará armazenado na geladeira do Laboratório de Genética Humana- Instituto Oswaldo Cruz (IOC)/ FIOCRUZ, sob a responsabilidade do pesquisador Mário Campos Júnior. Todo material genético que não for utilizado após o término das análises, será descartado.
- Todo e qualquer estudo do seu sangue diferente da proposta neste projeto só ocorrerá mediante o seu consentimento. Você responderá a um questionário a respeito de fatores associados ao diabetes. Caso não se sinta confortável, poderá se recusar a responder as perguntas.
- Você poderá se retirar da pesquisa a qualquer momento, se assim desejar, permanecendo com o direito ao acompanhamento no IEDE.
- Sua identidade será preservada, e os resultados obtidos ao final do estudo serão publicados em revistas médicas.
- Os resultados de exames e a avaliação do seu prontuário serão

Rubrica do paciente: _____ Rubrica do pesquisador: _____

1

utilizados somente pelos pesquisadores envolvidos nesse projeto e de outros profissionais que possam a vir a ter algum relacionamento de atendimento ou de cuidados com você. Nunca haverá qualquer tipo de discriminação contra você.

- Você não terá despesas em qualquer fase do estudo, nem com os exames. Também não haverá nenhum tipo de pagamento pela sua participação.
- Você terá direito a todos os resultados dos exames realizados durante a pesquisa, que serão fornecidos pelo pesquisador responsável (Dra. Roberta Magalhães Tarantino Mamede) ao final da pesquisa.
- Você tem o direito de esclarecer dúvidas com o pesquisador, e ser examinado antes e durante a realização do trabalho, e sempre que se fizer necessário. Você tem a garantia de que o IEDE manterá o atendimento médico conforme realizado anteriormente ao início do trabalho.
- Você não terá nenhum custo em participar da pesquisa. As despesas com transporte extra (fora dos dias da consulta) ou alimentação (se for necessária) serão pagas pelo pesquisador.
- Em caso de dúvidas durante o período da pesquisa, você poderá entrar em contato com a pesquisadora Roberta Tarantino (tel: 2332-7153 ou 99966-9635). Se você tiver alguma consideração ou dúvida sobre a ética da pesquisa, entre em contato com o Comitê de Ética em Pesquisa (CEP) do IEDE - Rua Moncorvo Filho nº 90 - Centro- Rio de Janeiro/RJ, 20211-340, pelo telefone 2224-3161 de segunda a sexta das 8 as 16 h ou através do email: cep.iede@iede.rj.gov.br

CONSENTIMENTO

Acredito ter sido suficientemente informado a respeito das informações sobre o estudo acima citado que li ou que foram lidas para mim.

Eu discuti com a Dra. Roberta Tarantino, sobre a minha decisão em participar nesse estudo. Ficou claro para mim quais são os propósitos do estudo, os procedimentos a serem realizados, seus desconfortos e riscos, as garantias de confidencialidade e de esclarecimentos permanentes. Ficou claro também que minha participação é isenta de despesas e que tenho garantia de acesso a tratamento hospitalar quando necessário. Concordo voluntariamente em participar desse estudo e poderei retirar o meu consentimento a qualquer momento, sem penalidades ou prejuízos e sem a perda de atendimento nesta Instituição ou de qualquer benefício que eu possa ter adquirido. Além disso, estou ciente de que eu (ou meu representante legal) e o pesquisador responsável por essa pesquisa deveremos rubricar todas as folhas desse Termo de Consentimento Livre e Esclarecido - TCLE, assinar a última página e que eu receberei uma via do TCLE assinada.

RJ, ___/___/_____ Nome do paciente _____

Assinatura paciente ou responsável legal

Assinatura pesquisador

Rubrica do paciente: _____ Rubrica do pesquisador: _____

7.3 Anexo C. Questionário

ANEXO 1 – QUESTIONÁRIO

Data da coleta dos dados:

Nome completo:

Número do prontuário:

Endereço/telefone:

Gênero:

Etnia:

Data de nascimento:

Diagnóstico principal: _____

Idade do diagnóstico de DM: _____ IMC ao diagnóstico de DM:

Cetoacidose diabética: Sim Não

Dados familiares:

1. Outros membros da família com diabetes? Sim Não Desconhece

(Se sim indique qual grau de parentesco e tipo de diabetes)

2. Algum membro da família com diabetes mellitus diagnosticado antes dos 35 anos? Sim

Não Desconhece

3. Diabetes em pelo menos 2 gerações ? Sim Não Desconhece

4. Outros membros da família em tratamento com insulina? Sim Não Desconhece

Informação Clínica:

5. Altura: _____ cm Peso: _____ kg

6. Glicemia de jejum: _____ (mg/dl)

7. Tratamento _____ Dose: _____
(Dieta, droga oral, insulina) _____ Dose: _____

8. HbA1c: _____ % (valor de referência: _____ - _____ %)

9. PCR ultrasensível: _____ (valor de referência: _____)

10. TSH: _____ T4I: _____

11. AntiTPO

Complicações:

10. Retinopatia Sim Não Desconhece

11. Doença Coronariana Sim Não Desconhece

12. Polineuropatia Sim Não Desconhece Teste monofilamento: positivo
negativo

13. Nefropatia Sim Não Desconhece

14. Cistos renais Sim Não Desconhece

15. Hipertensão arterial/sistêmica Sim Não Desconhece

16. Outras informações : _____

7.4 Anexo D. Resultados do sequenciamento de Sanger para o rastreamento dos 11 genes analisados

7.4.1 Resultados do sequenciamento de Sanger para o rastreamento do gene *GCK*

Paciente	GCK E1	GCK E2	GCK E3	GCK E4	GCK E5	GCK E6	GCK E7	GCK E8	GCK E9	GCK E10
1	N	N	N	c.449_451delTCT	N	N	N	N	N	N
7	N	N	N	N	c.571C>T	N	N	N	rs2908274	N
9	N	N	N	N	N	N	c.683C>T	N	N	N
29	N	N	N	N	N	N	c.680G>A	N	N	N
32	N	N	N	N	N	N	N	N	c.1151C>T	N
40	N	c.181T>G	N	N	N	N	N	N	rs2908274	N
42	N	N	N	N	N	rs2268574	N	N	rs2908274	N
45	N	N	N	N	N	N	N	N	N	c.1268T>A
46	N	N	c.343A>G	N	N	N	N	N	rs2908274	N
48	N	N	N	N	c.562G>A	N	N	N	rs2908274	N
50	N	c.130G>A	N	N	N	rs2268574	N	N	N	N
51	N	N	N	N	N	N	N	N	rs2908274	N
53	rs133006391	c.106C>T	N	N	N	rs2268574	N	N	N	N
54	N	N	N	N	N	rs2268574	N	N	N	N
55	N	N	N	N	N	rs2268574	N	N	c.1094_1095insGCCGA	N
58	N	N	N	N	N	N	N	N	N	c.1268T>A
59	N	N	N	N	N	c.626C>G	N	N	N	N
61	N	N	N	N	N	rs940824	N	N	N	N
63	N	N	N	N	N	rs940824	N	N	rs1378122273	c.1268T>A
67	N	c.115_117delAAG	N	N	N	rs2268574	N	N	N	N
68	N	N	N	N	N	rs2268574	N	N	c.1076C>T	N
69	N	N	N	N	N	N	N	N	rs2908274	N
74	N	N	N	N	N	N	N	N	N	N
75	N	c.128G>A	N	N	N	N	N	N	N	N
77	rs781260712	N	N	N	N	N	N	N	rs2908274	N
79	N	N	N	N	N	c.661G>A	N	N	rs2908274	N

Em vermelho e negrito estão destacadas as modificações provavelmente patogênicas. E: éxon; N: sequência normal; *GCK*, ENST00000403799.8.

7.4.2 Resultados do sequenciamento de Sanger para o rastreamento do gene *HNFI A*

Paciente	<i>HNFI A</i> E1	<i>HNFI A</i> E2	<i>HNFI A</i> E3	<i>HNFI A</i> E4	<i>HNFI A</i> E5	<i>HNFI A</i> E6	<i>HNFI A</i> E7	<i>HNFI A</i> E8	<i>HNFI A</i> E9	<i>HNFI A</i> E10
2	rs34056805 rs1169289 rs1169288 rs34056805	N	N	rs56348580	N	N	rs2259820 rs2464196	N	rs1169304 rs1169305	N
3	rs1169289	N	N	N	N	N	N	N	rs1169305	N
4	rs1169289 rs1169288 c.92G>A	N	N	N	N	N	rs2259820 rs2464196	N	rs1169304 rs1169305	N
5	N	N	N	rs56348580	N	c.1296_1297insC	N	N	rs1169304 rs1169305	N
6	rs1169289 rs1169288	N	N	rs56348580	N	N	N	N	rs1169304 rs1169305	N
8	rs1169289 rs1169288	N	N	N	N	N	rs2259820 rs2464196	N	rs1169304 rs1169305	N
10	rs1169289 rs1169288	N	N	N	N	N	rs2259820 rs2464196	N	rs1169304 rs1169305	N
11	N	N	N	rs56348580	N	N	N	rs55834942	rs1169305	N
12	rs1169289 rs1169288	N	N	rs56348580	N	N	rs2259820 rs2464196	N	rs1169305	N
13	rs1169289 rs1169288	c.493T>C	N	N	N	N	rs2259820 rs2464196	N	rs1169305	N
14	rs1169289	N	N	rs56348580	N	N	rs143015301	n/a	rs1169304 rs1169305	N
15	rs1169289 rs1169288	N	N	rs56348580	N	N	N	N	rs1169305	n/a
16	rs1169289 rs1169288	N	N	rs56348580	N	N	rs2259820 rs2464196	N	rs1169305	N
17	N	N	N	rs56348580	N	n/a	N	rs55834942	rs1169305	N
18	N	N	N	rs56348580	N	N	N	rs55834942	rs1169305	N
19	rs1169289 rs1169288	N	N	N	N	N	rs2259820 rs2464196	N	rs1169305	N
20	rs1169289	N	N	rs56348580	N	N	rs2259820 rs2464196	N	rs1169305	N
21	rs1169289 rs1169288	N	N	rs56348580	N	N	N	rs55834942	rs1169305	N
22	rs1169289	N	N	N	N	N	N	N	rs1169305	rs735396
23	N	N	N	rs56348580	N	N	N	rs55834942	rs1169305	N

24	N	N	N	N	N	N	N	N	rs1169305	N
25	rs1169289 rs1169288	N	N	rs56348580	N	N	rs2259820 rs2464196	N	rs1169305	N
26	rs1169289	N	N	N	N	N	rs2259820 rs2464196 rs2464195	N	rs1169304 rs1169305	rs735396
27	rs80051981	N	N	rs56348580	N	N	rs2259820 rs2464196 rs772786958 rs2464195 rs2259816	N	rs1169305	rs735396
28	N	c.398T>A	N	rs56348580	N	N	N	N	rs1169305	N
30	rs1169289	N	N	rs56348580	N	N	N	rs55834942	rs1169305	N
31	rs1169289 rs1169288	N	N	N	N	N	rs2259820 rs2464196	N	rs1169305	N
33	N	N	N	N	N	N	N	N	rs1169305	N
34	N	N	N	rs56348580	N	N	N	N	rs1169305	N
35	N	N	N	rs56348580	N	N	N	N	rs1169305	N
36	rs1169289 rs1169288	N	N	N	N	N	rs2259820 rs2464196	N	rs1169305	N
37	rs1169289 rs1169288	c.511C>T	N	N	N	N	rs2259820 rs2464196	N	rs1169305	N
38	N	N	N	N	N	N	N	N	rs1169305	N
39	N	N	N	N	N	N	N	N	rs1169305	N
41	rs1169289	N	N	N	N	N	N	N	rs1169305	N
43	rs1169289 rs1169288	N	N	N	N	N	rs2259820 rs2464196	N	rs1169305	N
44	rs1169289 rs1169288	N	N	c.811C>T rs56348580	N	N	rs2259820 rs2464196	N	rs1169305	rs735396
47	N	N	N	N	N	N	N	N	rs1169305	N
52	N	c.489C>G	rs2071190	rs56348580	N	N	N	rs1169304	rs1169305	N
56	N	N	N	rs56348580	N	c.1136_1137insC	N	rs1169304 rs142797154	N	N
57	N	N	N	rs56348580	N	N	N	rs1169304 rs142797154	N	N
60	N	N	N	rs56348580	N	rs556016526	rs2259820	rs55834942 rs1169304 rs1169305	N	N

62	rs1169289	rs1169294	rs1169301	rs56348580	N	N	rs2259820 rs2464196 rs2464195 rs2259816	rs55834942 rs1169304 rs1169305	N	rs735396
64	rs1169289	N	N	N	N	N	rs2464195 rs55919842	rs1169304	N	N
65	N	N	rs2071190	rs56348580	N	N	N	rs1169304 rs1169305	N	N
66	N	N	N	N	N	N	N	rs1169304 rs142797154	rs1169305	N
70	N	N	N	c.811C>T rs56348580	N	N	N	rs55834942	rs1169305	N
71	rs1169289 rs1169288	N	N	N	N	N	rs3213547 rs2259820 rs2464196	N	rs1169305	N
72	rs1169289 rs1169288	N	N	rs56348580	N	N	rs2259820 rs2464196	N	rs1169305	N
73	rs1169289 rs1169290	rs1169294	N	rs56348580	N	N	rs2259820 rs2464196 rs2464195	rs55834942	rs1169305	N
76	N	N	N	N	N	rs556016526	N	rs1169304	rs1169304 rs1169305	N
78	rs1169289 rs1169288	N	N	N	N	N	rs2259820 rs2464196	N	rs1169305	N

Em vermelho e negrito estão destacadas as variantes provavelmente patogênicas. E: éxon; N: sequência normal. n/a: não analisado *HNF1A*, ENST00000257555.10.

7.4.3 Resultados do sequenciamento de Sanger para o rastreamento do gene *HNF4A*

Paciente	<i>HNF4A</i> E1	<i>HNF4A</i> E2	<i>HNF4A</i> E3	<i>HNF4A</i> E4	<i>HNF4A</i> E5	<i>HNF4A</i> E6	<i>HNF4A</i> E7	<i>HNF4A</i> E8	<i>HNF4A</i> E9	<i>HNF4A</i> E10
2	rs113725562	rs745975 rs736823	N	N	N	N	N	N	N	N
3	N	N	N	N	N	N	N	N	N	N
6	N	N	N	N	N	N	N	rs3212207	N	N
8	N	N	N	N	N	N	N	N	N	N
10	N	N	N	N	N	N	N	N	N	N
11	N	N	N	N	N	N	*	*	N	N
12	N	N	N	N	N	N	N	N	N	N
16	N	N	N	N	N	N	N	N	N	N
19	rs113725562	rs736823	N	N	N	N	N	*	N	N
20	N	N	N	N	N	N	N	N	N	N
21	N	N	N	N	N	N	N	N	N	N
22	N	N	N	N	N	N	N	N	N	N
23	N	N	N	c.487C>T	N	N	N	N	N	N
24	N	N	N	N	N	N	N	N	N	N
25	N	N	N	N	N	N	N	N	N	N
26	N	N	N	N	N	N	N	N	N	N
30	N	rs736824 rs745975 rs736823	N	N	N	N	N	N	N	N
31	N	N	N	N	rs140376676	N	N	N	N	N
33	N	rs736823	N	N	N	N	N	N	N	N
34	N	rs745975 rs736823	N	rs113308087	N	N	N	N	N	N
35	N	rs736824	N	N	N	N	N	N	N	N
36	N	rs745975 rs736823	N	N	N	N	N	N	N	N

38	N	rs745975 rs736823	N	N	N	N	N	N	N	N
39	N	N	N	N	N	N	N	N	N	N
41	N	N	N	rs190319886 rs112708220 rs113308087	N	N	rs193922478	N	N	N
42	N	N	N	N	N	N	N	N	N	N
43	N	N	N	N	N	N	rs6031592	N	N	N
47	N	rs736824	N	N	N	N	N	N	N	N
51	N	rs745975 rs736823	N	N	N	N	N	N	N	N
54	N	rs371937621	N	N	N	N	N	N	N	N
57	N	N	N	N	N	N	N	N	N	N
60	N	N	N	N	N	N	N	N	N	N
61	N	N	N	N	N	N	N	N	N	N
62	N	rs371937621	N	N	N	N	N	N	rs61737145	N
64	N	N	N	N	N	N	N	N	N	N
65	N	N	rs896163918	N	N	N	N	N	N	N
66	N	N	N	N	N	rs139591750	N	N	N	N
69	rs113725562	rs736823	N	N	N	N	N	N	N	N
71	N	N	N	N	N	N	N	N	N	N
73	N	N	N	N	N	N	N	N	N	N
74	N	N	rs112386711	N	N	N	N	rs3212207	N	N
76	N	N	N	N	N	N	N	N	N	N
77	N	N	N	N	N	N	N	N	N	N
78	N	N	N	N	N	N	N	N	N	N

Em vermelho e negrito estão destacadas as variantes provavelmente patogênicas. E: éxon; N: sequência normal. *Material genético (DNA) insuficiente para realizar o experimento; *HNF4A*, ENST00000316099.8.

7.4.4 Resultados do sequenciamento de Sanger para o rastreamento do gene *HNF1B*

Paciente	<i>HNF1B</i> E1	<i>HNF1B</i> E2	<i>HNF1B</i> E3	<i>HNF1B</i> E4	<i>HNF1B</i> E5	<i>HNF1B</i> E6	<i>HNF1B</i> E7	<i>HNF1B</i> E8	<i>HNF1B</i> E9
2	N	N	N	N	N	N	N	rs35913775	N
3	N	N	N	N	N	N	N	N	N
8	N	N	N	N	N	N	N	* rs2269842	N
10	N	c.351C>T	N	N	N	N	N	N	N
12	N	N	N	N	N	N	N	* rs359113775	rs3110641
19	*	N	rs114017141	N	N	N	N	N	N
21	N	N	N	N	N	N	N	* rs359113775	rs3110641 rs2229295
22	N	N	N	N	N	N	N	* rs359113775	rs1800929
23	N	N	N	N	*	N	N	rs2269842	N
24	N	N	N	N	N	N	N	rs2269842	N
25	N	N	N	N	N	N	N	rs2269842	rs3110641
26	N	N	N	N	N	N	rs2074429	rs2269842	N
30	N	N	N	N	N	N	N	N	N
31	N	N	N	N	N	N	N	rs2269842	rs3110641 rs2229295 rs1800929 rs8066605
33	N	N	N	N	N	rs2107133	N	rs2269842	rs3110641 rs2229295 rs1800929
34	rs111699857	N	N	N	N	N	N	N	rs3110641 rs2229295
35	N	N	N	N	N	rs2107133	N	N	N
36	N	N	N	N	N	N	N	N	N
38	N	N	N	N	N	rs2107133	N	rs35913775	N
39	N	N	N	N	N	N	N	rs2269842	rs3110641 rs2229295

41	N	N	N	N	N	rs199849203	N	N	N
42	N	N	N	N	N	N	N	rs35913775	N
43	N	N	N	N	N	N	N	rs35913775	rs3110641 rs2229295 rs1800929
47	N	N	rs9895048	N	N	N	N	rs2269843	rs2229295
51	N	N	N	N	N	N	rs9905004	* rs35913775	N
54	N	N	N	N	N	N	rs2074429	N	N
57	N	N	N	N	N	N	rs9905004	rs2269842	rs8066605
60	N	N	N	N	N	N	N	rs2269842	rs3110641
61	N	N	N	N	N	N	rs2074429 rs9905004	N	N
62	N	N	N	N	N	N	N	rs2269842	N
64	N	N	N	N	N	N	rs77297671	* rs35913775	N
65	N	N	N	c.826C>T	N	N	rs2074429	N	N
66	N	N	N	N	N	N	rs9905004	rs2269842	N
69	N	N	N	N	N	N	N	rs2269842	N
71	N	N	N	N	N	N	N	N	rs3110641
73	N	N	N	N	N	N	N	N	N
74	N	N	N	N	N	N	N	N	rs3110641
76	N	N	N	N	N	N	N	rs2269842	rs8066605 rs3110641
77	N	N	N	N	N	N	N	rs2269842	rs3110641
78	N	N	N	N	N	N	N	rs2269842	N

Em vermelho e negrito estão destacadas as variantes provavelmente patogênicas. E: éxon; N: sequência normal; *Material genético (DNA) insuficiente para realizar o experimento; *HNF1B*, ENST00000617811.5.

7.4.5 Resultados do sequenciamento de Sanger para o rastreamento dos genes *INS*, *PDX1*, *NEUROD1*, *KCNJ11* e *KLF11*

Paciente	<i>INS</i> E1	<i>INS</i> E2	<i>PDX1</i> E1	<i>PDX1</i> E2	<i>NEUROD1</i>	<i>KCNJ11</i>	<i>KLF11</i> E1	<i>KLF11</i> E2	<i>KLF11</i> E3	<i>KLF11</i> E4
2	N	N	N	N	rs1801262	rs5219 rs5218 rs5215	rs1476684022	N	N	rs77596732
3	N	N	N	N	rs1801262	rs5219 rs372471215 rs5215	N	rs1440218281	rs11687357	N
6	rs5506	N	N	N	rs1801262	*	*	*	*	*
8	N	N	N	N	N	rs5219 rs5220 rs5215	N	N	rs11687357	N
10	rs689 rs5506	rs3842753	N	N	rs1801262	rs5219 rs139445409 rs5215	N	N	rs11687357 rs1428386222	N
12	rs689 rs5506	rs3842753	N	c.732_733insCCC	rs1801262	rs5219 rs5215	N	rs1440218281	rs11687357	N
19	rs689	rs3842753	N	*	rs1801262	*	*	*	*	*
20	rs689	rs3842753	N	N	rs1801262	rs5219 rs5218 rs5215	N	N	*	N
21	rs689	N	rs28509441	N	rs1801262	rs5219 rs5215	N	N	*	N
22	rs689 rs5506	rs3842753	N	N	rs1801262	rs5219 rs5218 rs5215	rs1476684022	N	rs11687357	N
23	rs689	rs3842753	N	N	rs1801262	rs5219 rs5215	N	N	N	N
24	rs689	rs3842753	N	N	rs1801262 c.766_767delTT	rs5219 rs5214 rs5215	N	N	rs11687357	N
25	N	N	N	c.532G>A rs193922358	rs1801262	rs5219 rs5215	N	N	rs11687357	N
26	N	N	N	N	*	* rs5219 rs5215	N	N	rs11687357	N
30	rs689	N	N	N	rs1801262	rs5219 rs5218 rs5215	N	rs1440218281	rs11687357	N
31	rs689	rs3842753	N	N	rs1801262 rs142123958	rs5219 rs5215 rs1800467	N	N	rs11687357	N

33	rs689	rs995882391 rs3842753	N	N	rs1801262	* rs5219 rs5215	N	N	rs11687357	N
34	rs689 rs5506	rs5507 rs3842753	N	N	N	rs5219 rs5215	N	rs1440218281	rs11687357	N
35	rs3842744	N	N	N	rs1801262	rs5219 rs5215	N	rs1440218281	rs11687357	N
36	N	N	N	N	rs1801262	rs5219 rs5215 rs1800467	N	N	N	N
38	N	N	N	N	rs1801262	rs1800467	N	N	N	N
39	N	N	N	N	rs1801262	rs5219 rs5215	N	N	rs11687357	N
41	rs689	rs3842753	N	N	rs1801262	rs5219 rs5215	N	N	rs11687357	N
42	N	N	N	rs199644078	rs1801262	rs5219 rs5218 rs5215	N	N	rs11687357	N
43	N	rs5507	N	N	rs1801262 rs8192556	rs5219 rs5215	N	N	rs11687357	N
47	rs689	rs3842753	N	rs199644078	rs1801262	* rs5215	N	N	rs11687357	N
51	N	rs3842752 rs3842753	N	N	rs1801262	rs5219 rs5218 rs5215	N	N	N	N
54	rs5506	rs893961287	N	N	rs1801262	rs5219 rs5218 rs5215	N	N	rs11687357	N
57	N	N	N	N	N	rs5219 rs5218 rs5215	N	*	rs11687357	N
60	N	N	N	N	rs1801262	rs5219 rs5218 rs5215	N	N	rs11687357	N
61	N	rs3842753	N	N	rs1801262	rs5219 rs5215	N	N	rs11687357	N
62	N	rs3842752 rs3842753	N	N	rs1801262	N	N	N	rs1428386222 rs11687357	N
64	N	N	N	N	rs1801262	rs5219 rs5215	N	rs35927125	rs11687357	N
65	N	rs3842752 rs3842753	N	N	rs1801262	rs5219 rs5215	N	N	rs11687357	N
66	N	rs3842753	N	N	N	rs5219 rs5215	N	N	*	N
69	rs689	rs3842749	N	N	rs1801262	rs5219	N	N	rs11687357	N

						rs5218 rs5215				
71	rs689 rs5506	N	N	N	rs1801262	rs5219 rs5215	N	N	rs11687357	N
73	N	N	N	N	rs1801262	rs5219 rs5215	N	rs35927125	rs11687357	N
74	rs689	N	N	N	rs1801262	rs5219 rs5215	N	N	rs11687357	N
76	N	N	N	N	rs1801262	rs5219 rs5218 rs5215	N	N	rs11687357	N
77	N	N	N	N	rs1801262	rs5219 rs5215	N	N	rs11687357	N
78	N	N	rs564129447	N	rs1801262	rs5219 rs5215	N	N	rs11687357	rs151292984

Em vermelho e negrito estão destacadas as variantes provavelmente patogênicas. *Material genético (DNA) insuficiente para realizar o experimento; E: éxon; N: sequência normal. *INS*, ENST00000381330.5; *PDX1*, ENST00000381033.5, *NEUROD1*, ENST00000295108.3; *KLF11*, ENST00000305883.6.

7.4.6 Resultados do sequenciamento de Sanger para o rastreamento dos genes *PAX4* e *MT-TL1*

Paciente	<i>PAX4</i> E1	<i>PAX4</i> E2	<i>PAX4</i> E3	<i>PAX4</i> E4	<i>PAX4</i> E5	<i>PAX4</i> E6	<i>PAX4</i> E7	<i>PAX4</i> E8	<i>PAX4</i> E9	<i>MT-TL1</i>
2	N	N	N	rs327517	N	N	N	N	rs712701	N
3	N	N	N	N	N	N	N	N	rs712701	N
8	N	N	N	N	N	N	N	N	rs712701	N
10	N	N	N	N	N	N	N	N	rs712701	N
12	N	N	N	N	N	N	N	N	rs712701	N
20	N	N	N	N	N	N	N	N	rs712701	N
21	N	N	N	rs327517	N	N	N	N	rs712701	N
22	N	N	N	N	N	N	N	N	rs712701	N
23	N	N	*	N	N	N	*	N	rs712701	N
24	N	N	N	N	N	N	N	N	rs712701	N
25	N	N	rs2233578	N	N	N	N	N	rs712701	N
26	N	N	N	N	N	N	N	N	rs712701	m.3243A>G
30	N	N	N	N	N	N	N	N	rs712701	N
31	N	N	N	N	N	N	N	N	rs712701	N
33	N	N	N	N	N	N	N	N	rs712701	N
34	N	N	N	N	N	N	N	N	rs712701	N
35	N	N	N	c.515G>A	N	N	N	N	rs712701	N
36	N	N	N	N	N	N	N	N	rs712701	N
38	N	N	N	N	N	N	N	N	rs712701	N
39	N	N	N	N	N	N	N	N	rs712701	N
41	N	N	N	rs327517	N	N	N	N	rs712701	N
42	N	N	N	rs327517	N	N	N	N	rs712701	N
43	N	N	N	rs327517	N	N	N	N	rs712701	N

47	N	N	rs2233578	N	N	N	N	N	N	N
51	N	N	N	N	N	N	N	N	rs712701	N
54	N	N	N	rs77039439	N	N	N	N	rs712701	N
57	N	N	rs2233578	N	N	N	N	N	N	N
60	N	N	N	N	N	N	N	N	rs712701	N
61	N	N	rs2233578	N	N	N	N	N	rs712701	N
62	N	N	N	N	N	N	N	N	rs712701	N
64	N	N	N	N	N	N	N	N	rs712701	N
65	N	N	N	N	N	N	N	N	N	N
66	N	N	N	N	N	N	N	N	rs712701	N
69	N	N	N	N	N	N	N	N	rs712701	N
71	N	N	N	N	N	N	N	N	rs712701	N
73	N	N	N	*	N	N	N	N	rs712701	N
74	N	N	N	N	N	N	N	N	rs712701	N
76	N	N	N	N	N	N	N	N	rs712701	N
77	N	N	N	N	N	N	N	N	rs712701	N
78	N	rs112061448	rs2233578	N	N	N	N	N	N	N

Em vermelho e negrito estão destacadas as variantes provavelmente patogênicas. *Material genético (DNA) insuficiente para realizar o experimento; E: éxon; N: sequência norma. *PAX4*, ENST00000639438.3; *MT-TL1*, ENST00000386347.

7.5 Anexo E. Modelo de relatório de pesquisa

Fundação Oswaldo Cruz - FIOCRUZ
Instituto Oswaldo Cruz - IOC
Laboratório de Genética Humana - LGH
Av. Brasil, 4305 (Mangueiras)
Pavilhão Leônidas Deane, 2º andar
Tel: 3065-6192

Rio de Janeiro, __ de _____ de _____.

RELATÓRIO DE PESQUISA

Nome (Sigla): _____ ()

Sexo: Feminino () Masculino ()

DN: __/__/__

Tipo de amostra: Sangue () Saliva ()

Teste realizado: Sequenciamento: de Sanger () de segunda geração painel () do Exoma ()

Indicação para o teste: Diabetes mellitus

O indivíduo é participante do projeto de pesquisa *Diagnóstico Molecular em pacientes jovens com diabetes mellitus e história familiar positiva*, aprovado no Comitê de Ética em Pesquisa (número do parecer: CAAE nº _____) do _____ do Rio de Janeiro. Neste projeto, avaliamos a presença de mutações nos genes relacionados ao diabetes monogênico.

Características da variante encontrada:

Gene	Zigossidade	Coordenada Genômica (GRCh37)	cDNA	Predição na proteína	Transcrito	Referência bibliográfica

Figuras contendo o resultado do sequenciamento de um indivíduo com sequência selvagem (A) e a sequência do paciente no primeiro experimento (B) e na repetição (C):

Figura A

Figura B

Figura C

Interpretação: A variante c.____ (p.____) encontrada em *heterozigose/homozigose* no gene ____ apresenta frequência de ____, ____, ____ nos bancos de dados controles como o ExAC, 1000 genomas e ABRaOM, respectivamente. Esta variante que leva a ____ do aminoácido de ____ na posição ____ da proteína foi predita como causadora da doença com probabilidade de ____ por ____ softwares de predição de patogenicidade *in silico*. Ela foi descrita anteriormente nos estudos _____, _____ e _____. Entretanto, tais resultados não são fundamentados em dados experimentais da proteína em questão e devem ser interpretados com cautela.

Métodos: Extração de DNA, reação em cadeia da polimerase e sequenciamento de DNA.

Observação: Todos os experimentos deste projeto foram realizados em um ambiente de pesquisa científica, utilizando reagentes e processos adequados à pesquisa. O uso destes resultados não é adequado para o diagnóstico sem a cuidadosa interpretação do clínico responsável.